

UC Santa Barbara

UC Santa Barbara Electronic Theses and Dissertations

Title

Serotonergic contributions to the anxiogenic effects of cocaine

Permalink

<https://escholarship.org/uc/item/5th4d579>

Author

Klein, Adam

Publication Date

2018

Peer reviewed|Thesis/dissertation

UNIVERSITY OF CALIFORNIA

Santa Barbara

Serotonergic contributions to the anxiogenic effects of cocaine

A dissertation submitted in partial satisfaction of the requirements
for the degree of Doctor of Philosophy in Psychological and Brain Sciences

by

Adam Keith Klein

Committee in charge:

Professor Aaron Ettenberg, Chair

Professor Karen Szumlinski

Professor Skirmantas Janusonis

Professor Kyle Ratner

June 2018

The dissertation of Adam Keith Klein is approved.

Professor Kyle Ratner

Professor Skirmantas Janusonis

Professor Karen Szumlinski

Professor Aaron Ettenberg, Committee Chair

June 2018

Acknowledgements

First, I would like to thank my mentor and advisor, Dr. Aaron Ettenberg. Your willingness to take a chance on me, and to provide me with guidance and support throughout this process has been instrumental in my development as both a scientist and as a person. Your optimism and ability to face life's most difficult challenges with grace has been truly inspirational.

I would also like to thank my dissertation committee, Drs. Karen Szumlinski, Skirmantas Janusonis, and Kyle Ratner, for their support and insight. Thanks to all of you for urging me to think more deeply about my research and for your willingness to share your time, expertise, and sometimes without even knowing it-- your lab equipment and reagents, as well!

Next, I would like to thank all my lab mates, who made this whole process a fun and enjoyable work environment. Especially Erin Purvis, for always being at my side, for making the long surgery marathons more entertaining, and for keeping the lab under control and running like clockwork! And to Dr. Kerisa Shelton & Sam Cotten, for your willingness to teach me all the skills you had learned over the years.

To my family, for all your love and support, even when you don't always understand what I'm doing. Thank you for letting me pursue my dream of moving to California to study neuroscience.

And finally, to my wonderful fiancée Lynx Marks, your love and encouragement (and baked goods, too!) have helped make this writing process an enjoyable experience. Your work ethic and dedication have been inspirational, and I couldn't have done this without

you. This work was supported by NIDA grant DA-033370 awarded to Dr. Aaron Ettenberg, and by a UCOP Dissertation Year Fellowship awarded to Adam Klein.

Adam Keith Klein

4890 Kodiak Ave | Santa Barbara, CA 93111 | (cell) 201.753.0570 |
adam.klein@psych.ucsb.edu

EDUCATION

University of California, Santa Barbara (UCSB) **Santa Barbara, CA**

Department of Psychological & Brain Sciences

- PhD, Psychological & Brain Sciences Expected June 2018
- Thesis Title: *Serotonergic contributions to the anxiogenic effects of cocaine*
- MA, Psychology 2015
- Thesis Title: *Activation of 5-HT1b Receptors in the Bed Nucleus of the Stria Terminalis Attenuates the Negative/Anxiogenic Effects of Cocaine*
- Mentor: Professor Aaron Ettenberg

The City College of New York (CUNY-CCNY) **New York, NY**

Department of Psychology

- BS, Psychology 2013

RESEARCH EXPERIENCE

Behavioral Pharmacology Laboratory, UCSB **Santa Barbara, CA**

Graduate Student Researcher (PI: Aaron Ettenberg) June 2013 – Present

- Involved in ongoing research focused on the neurobiological basis of the negative/anxiogenic effects produced by cocaine self-administration
- Involved in collaborative studies on the behavioral effects of unique lithium isotopes on rodent behavior

Neurochemistry of Learning Laboratory, CCNY **New York, NY**

Undergraduate Research Assistant (PI: Jon Horvitz) 2012 – 2013

- Assisted graduate students with projects investigating glutamate signaling in the Nucleus Accumbens as it relates to reinforcement learning

Substance Use Resource Center, Columbia University **New York, NY**

Undergraduate Research Assistant (PI: Carl Hart) 2011 – 2012

- Assisted graduate students with projects investigating the cognitive deficits in long-term heavy cannabis users

Teaching Experience

Department of Psychological & Brain Sciences
University of California, Santa Barbara

Santa Barbara, CA

Instructor of Record

- Neuropharmacology (PSY 115) 2017
- Motivation (PSY 122) 2016
- Psychopharmacology (PSY 134) 2016

Laboratory Teaching Assistant

- Laboratory in Behavioral Pharmacology (PSY 111L) 2014-2017

Teaching Assistant

- Intro to Biopsychology (PSY 3) 2013, 2016
- Learning & Conditioning (PSY 116) 2016
- Motivation (PSY 122) 2015
- Intro to Psychology (PSY 1) 2014
- Topics in Behavioral Neuroscience (PSY 111) 2014

RELEVANT LABORATORY SKILLS

- IV catheterization and intracranial stereotaxic surgery (rodent)
- Transcardiac perfusion (rodent)
- Injections and inoculations, intracranial microinjections (rodent)
- Optogenetic methodology
- Drug preparation and administration (IP, IV, IC)
- Behavioral assays: runway model of drug self-administration, locomotor activity, open field test, conditioned place preference (CPP), elevated plus maze, operant-box self-administration, startle-response
- Histological analysis and immunocytochemistry
- qPCR
- Mathematica modeling
- SPSS statistical software

AWARDS & FELLOWSHIPS

- UC President's Dissertation Year Fellowship UCSB, 2017-2018
- Harry J. Carlisle Award (outstanding doctoral student, Neuroscience) UCSB, 2017

- Richard E. Mayer Award (for best 2nd year paper) UCSB, 2015
- Ward Medal for highest GPA in the department (4.0) CCNY, 2013
- Psi Chi Honors Society CCNY, 2012

Professional Memberships

- College on Problems of Drug Dependence (CPDD) 2017-Present
- Society for Neuroscience (SfN) 2013-Present

PUBLICATIONS

1. **Klein, A.K.**, Purvis, E.M., Ayala, K., Collins, L., Guillen, A., James, B., Kang, M., Krug, J., Lee, K., Mayes, M., McCann, J., Murphy, A., Wu, D., Zhou, L., & Ettenberg, A. (2018).

Activation of 5-HT_{1B} receptors in the Lateral Habenula attenuates the negative/anxiogenic effects of cocaine. Behavioral Brain Research. 10.1016/j.bbr.2018.04.014

2. Purvis, E.M., **Klein, A.K.**, & Ettenberg, A. (2018).

Lateral habenular norepinephrine contributes to anxiogenic behaviors in male rats. Behavioral Brain Research, 348, 108-115

3. **Klein, A.K.**, Brito, M.A., Akhavan, S., Flanagan, D.R., Le, N., Ohana, T., Patil, A.S., Purvis, E.M., Provenzano, C., Wei, A., Zho, L., & Ettenberg, A. (2017).
Attenuation of the anxiogenic effects of cocaine by 5-HT_{1B} autoreceptor stimulation in the Bed Nucleus of the Stria Terminalis of rats. Psychopharmacology, 234, 485-495.

4. Ettenberg, A., Cotten, S.W., Brito, M.A., **Klein, A.K.**, Ohana, T.A., Margolin, B., Wei, A., & Wenzel, J.M. (2015)

CRF antagonism within the ventral tegmental area but not the extended amygdala attenuates the anxiogenic effects of cocaine in rats Pharmacology, Biochemistry and Behavior, 2015, Vol. 138, pp. 148-155

CONFERENCE PRESENTATIONS & PUBLISHED ABSTRACTS

1. **Adam Klein**, Erin M. Purvis, Kathy Ayala, Lisette Collins, Aileen Guillen, Brian James, Jacob Krug, Kiana Lee, Matthew Mayes, Lucy Zhou, and Aaron Ettenberg.

Activation of serotonin _{1B} receptors in the lateral habenula attenuates the negative/anxiogenic effects of cocaine. 334.20/TT15 2017 Neuroscience Meeting Planner. Washington, D.C.: Society for Neuroscience, 2017. Online.

2. Erin M. Purvis, **Adam Klein**, Lisette Collins, Aileen Guillen, Brian James, Kiana Lee, Matthew Mayes, Lucy Zhou, and Aaron Ettenberg.

Lateral habenular norepinephrine contributes to anxiogenic behaviors in male rats. 334.19/TT14 2017 Neuroscience Meeting Planner. Washington, D.C.: Society for Neuroscience, 2017. Online.

3. **Adam Klein**, Sayeh Akhavan, Michael Brito, Dylan Flanagan, Kiana Lee, Anand S. Patil, Erin Purvis, Alex Wei, Lucy Zhou, and Aaron Ettenberg.

Serotonin 1B Receptors in the Bed Nucleus of the Stria Terminalis contribute to the negative/anxiogenic effects of cocaine 350.14/FFF11 2016 Neuroscience Meeting Planner. San Diego, CA: Society for Neuroscience, 2016. Online.

4. **Adam Klein**, Michael Brito, Nikki Le, Tatum Ohana, Anand Patil, Carl Provenzano, and Aaron Ettenberg.

Activation of serotonin 1B autoreceptors in the Bed Nucleus of the Stria Terminalis attenuates the negative/anxiogenic effects of cocaine 315.16/J26 2015 Neuroscience Meeting Planner. Chicago, IL: Society for Neuroscience, 2015. Online

5. Samuel Cotten, **Adam Klein**, Michael Brito, Tatum Ohana, Ben Margolin, Alex Wei, and Aaron Ettenberg.

Intra-VTA infusions of the CRF antagonist astressin-B reduces the anxiogenic response to cocaine in a runway model of drug self-administration. 54.06/V29 2014 Neuroscience Meeting Planner. Washington, DC: Society for Neuroscience, 2014. Online.

SERVICE/VOLUNTEER EXPERIENCE

UCSB Society of Undergraduate Psychologists (SUP)

Graduate Student Mentor

Santa Barbara, CA

2017 - Present

- Provided mentorship to undergraduate students interested in pursuing a graduate degree in psychology or neuroscience

Santa Barbara Jewish Federation

Volunteer

Santa Barbara, CA

2015 – Present

- Founded Kosher food bank for local elderly residents
- Assisted with running various events

The Fortune Society*GED Tutor***Queens, NY**

2011 – 2013

- Tutored individual students and small groups to prepare them for the GED Mathematics exam

MENTORSHIP

Undergraduate Student Mentorship

1. Tatum Ohana (2013-2015)
2. Michael Brito (2013-2014)
3. Ben Margolin (2014)
4. Alex Wei (2014-2016)
5. Nikki Le (2014-2015)
6. Carl Provenzano (2014-2015)
7. Anand Patil (2014-2016)
8. Dylan Flanagan (2015-2016)
9. Sayeh Akhavan (2015-2016)
10. Kiana Lee (2015-2016)
11. Lucy Zhou (2015-2017)
12. Aileen Guillen (2016-2017)
13. Brian James (2016-2017)
14. Matthew Mayes (2016-2018)
15. Lisette Collins (2016-2018)
16. Kathy Ayala (2017-2018)
17. Jacob Krug (2017-2018)
18. James McCann (2017-2018)
19. David Wu (2017-2018)
20. Matt Kang (2017-2018)
21. Alex Murphy (2017-2018)

Honors Student Mentorship

1. Erin Purvis (2016-2017)
2. Mona Ahikary (2017-2018)

Graduate Student Peer Mentor

1. Melissa Hingorani (2017-2018)

Abstract

Serotonergic contributions to the anxiogenic effects of cocaine

By

Adam Keith Klein

Self-administration of cocaine produces an initially euphoric or “high” state, following shortly after by an aversive, anxiogenic “crash”. Although there has been extensive research into the neurobiology of cocaine’s rewarding effects, less attention has focused on understanding the mechanisms of the drug’s aversive component. Recent research has identified regions like the Bed Nucleus of the Stria Terminalis (BNST) and Lateral Habenula (LHb) as key structures that contribute to aversive effects in humans and animals. The specific intent of this dissertation is to investigate the role of serotonin (5-HT) signaling in these two regions as it contributes to the negative effects of cocaine. Three main studies were designed and executed to address this question. First, to assess the role of 5-HT perturbations within the BNST on the development of approach-avoidance retreat behavior in animals trained to run an alley for cocaine. Next, the same methods were used to investigate the role of 5-HT signaling within the LHb, as animals learned about cocaine’s negative effects. Finally, the third study used selective lesions of serotonin fibers in both the LHb and BNST to determine a more precise mechanism of the observed serotonergic effects. Altogether, the experiments described in this thesis support a role for 5-HT signaling, in both regions, in mediating the behavioral consequences of cocaine’s aversive properties.

Table of Contents

Chapter 1: Introduction.....	1
Chapter 2: General Methodology.....	32
Chapter 3: Cocaine, Serotonin, and the BNST.....	44
Chapter 4: Cocaine, Serotonin, and the LHb.....	63
Chapter 5: Effects of selective serotonergic lesions of the BNST & LHb on runway approach-avoidance behavior in rats working for cocaine.....	80
Chapter 6: General Discussion.....	94
References.....	114

Index of Tables and Figures

Figure 1.1. Schematic diagram of Solomon & Corbit’s “Opponent Process Theory of Motivation”	8
Figure 1.2. Schematic diagram of brain circuits involved with the positive and negative actions of cocaine.....	15
Figure 2.1. Schematic diagram of the runway self-administration apparatus.....	38
Figure 2.2. Experimental Timeline.....	41
Figure 3.1. Histological confirmation of cannula placements in the BNST.....	50
Figure 3.2. Experiment I: CP 94,253 in the BNST.....	52
Figure 3.3. Experiment II: CP 94,253 post-treatment.....	57
Figure 3.4. Experiment II: CP 94,254 + NAS-181 in the BNST.....	58
Figure 3.5 Spontaneous locomotor activity	59
Figure 4.1. Histological confirmation of cannula placements in the LHb.....	68
Figure 4.2. Experiment IV: CP 94,253 in the LHb.....	70
Figure 4.3 Experiment V: Bar graphs of run times and retreats.....	71
Table 4.1 Correlations between run time and approach-avoidance retreat frequency.....	73
Figure 4.4. Experiment VI: CP 94,253 + NAS-181 in the LHb.....	76
Figure 4.5. Spontaneous locomotor activity.....	77
Figure 5.1. Experiment VII: Selective 5-HT lesion of the LHb.....	87
Figure 5.2. Experiment VIII: Selective 5-HT lesion of the BNST.....	89
Figure 5.3 Spontaneous locomotor activity.....	91

Chapter 1. Introduction

Cocaine is a stimulant drug that is widely used by humans for recreational purposes. Per the National Survey on Drug Use and Health (NSDUH), nearly one million Americans abused, or were dependent on cocaine in 2011. Cocaine and other drugs of abuse put a large strain on the economy, with costs related to lost productivity, crime and health care (ONDCP,2014). Additionally, cocaine users have been shown to be at significantly higher risk for such ailments as heart attack, respiratory disease, stroke, and seizures (Caplan, Hier, & Banks, 1982; Gradman, 1988; Lathers, Tyau, Spino, & Agarwal, 1988). Given the adverse impact of cocaine use on the health of both the individual and the nation, there has been considerable interest in research aimed at understanding the factors that lead to cocaine abuse, especially the underlying neurobiological mechanisms that motivate cocaine consumption.

1.1 Cocaine & Anxiety

Research into the effects of cocaine in humans has shown that the drug produces an initial sense of intense pleasure, which is followed by a number of negative effects, including anxiety, dysphoria, irritability, and cravings for the drug (Anthony, Tien, & Petronis, 1989; Resnick, Kestenbaum, & Schwartz, 1977; Rohsenow, Martin, Eaton, & Monti, 2007; Williamson, Gossop, Powis, Griffiths, Fountain, & Strang, 1997). Indeed, cocaine has been shown to exacerbate anxiety seen in patients suffering from mental disorders such as schizophrenia (Serper, Alpert, Richardson, Dickson, Allen, & Werner, 1995) and post-traumatic stress

disorder (Hamner, 1993), as well as to induce panic attacks (Anthony et al., 1989; Cox, Ron Norton, Swinson, & Endler, 1990). These anxiogenic effects are believed to drive individuals who use cocaine to concomitantly consume alcohol (Carroll, Rounsaville, & Bryant, 1993; Grant & Harford, 1990), heroin (Anthony et al., 1989; Cox et al., 1990; Spotts & Shontz, 1984) or other anxiolytic agents (Sheehan, Sheehan, Torres, Coppola, & Francis, 1991; Williamson et al., 1997) as a means of counteracting the adverse side effects of the drug.

The anxiogenic properties of cocaine have also been demonstrated across numerous animal models of anxiety. While animals will reliably self-administer cocaine (Deneau, Yanagita, & Seevers, 1969; Hill & Powell, 1976) and develop preferences for environments paired with the immediate positive effects of the drug (Mucha, Van Der Kooy, O'Shaughnessy, & Bucenieks, 1982; Spyraiki, Fibiger, & Phillips, 1982), cocaine administration has also been shown to decrease exploration of the center area of an open field (Simon, Dupuis, & Costentin, 1994; Yang, Gorman, Dunn, & Goeders, 1992), increase the aversive response to the brightly illuminated "light" area of a light/dark box (Costall, Elizabeth Kelly, Naylor, & Onaivi, 1989), and decrease entries into the open arms of an elevated plus maze (Costall, Domeney, Gerrard, Horovitz, Kelly, Naylor, & Tomkins, 1990; Paine, Jackman, & Olmstead, 2002; Rogerio & Takahashi, 1992). Cocaine also increases defensive behaviors in rodents, including; avoidance/escape, flight, freezing, threat vocalization, and defensive attack (for review, see Blanchard & Blanchard, 1999).

Many of these behaviors are sensitive to anxiolytic drugs, providing further evidence that they stem from an anxiogenic mechanism of cocaine (Blanchard & Blanchard, 1999; Costall et al., 1990, 1989; Simon et al., 1994).

Additionally, while rats will readily develop a conditioned place preferences for environments paired with the immediate/positive effects of cocaine, they exhibit conditioned place *aversions* for environments paired with the delayed/negative effects of the drug present 15 minutes after intravenous injection (Ettenberg & Bernardi, 2007; Ettenberg, Fomenko, Kaganovsky, Shelton, & Wenzel, 2015; Ettenberg, Raven, Danluck, & Necessary, 1999; Jhou, Good, Rowley, Xu, Wang, Burnham, Hoffman, Lupica, & Ikemoto, 2013). Just as with other anxiety-like behaviors, co-administration of anxiolytic drugs abolishes the development of conditioned place aversions to cocaine's delayed/negative effects (Ettenberg & Bernardi, 2007; Knackstedt, Samimi, & Ettenberg, 2002). Importantly, the delayed negative effects produced by cocaine administration begin while blood plasma levels of the drug are still quite high (Dyke, Barash, Jatlow, & Byck, 1976). This suggests that the drug's anxiogenic effects are not a result of drug withdrawal, but, rather, of cocaine's ability to activate specific biological processes that are ultimately responsible for its initial positive and subsequent negative actions.

1.2 Opponent Process Theory

The dual and opposing properties of cocaine align well with Solomon and Corbit's (1974) *Opponent-Process Theory of Motivation*. In their paper, the authors

propose that any stimulus capable of eliciting an emotional response elicits two affective responses that are temporally dissociated and diametrically opposite in valence. They postulated,

“First following the sudden introduction of either a pleasurable or aversive stimulus, an affective or hedonic reaction begins and quickly rises to a peak. It then slowly declines to a steady level where it remains if the stimulus quality and intensity is maintained. Then, at the sudden termination of the stimulus, the affective reaction quickly disappears and gives way to a qualitatively different type of affective reaction, which reaches its own peak of intensity and then slowly disappears with time.” (Solomon & Corbit, 1974; pg 120).

Solomon and Corbit termed these the “A” and “B” processes. Upon stimulus presentation (e.g., administration of a drug), the initial A response is activated, increases to a plateau, and then decays rapidly. The secondary B response is diametrically opposite in affective valence and therefore intended to counteract the A response and bring the organism back to affective homeostasis. The onset of the B process is delayed relative to that of the initial A process and is therefore described as being “enslaved” to the A process – i.e. without the activation of the A process, the B process would not occur. Accordingly, the net subjective experience of any affective stimulus would be composed of the summation of both A and B processes, with the initial experience being driven by A process (termed the “A state”) shortly

followed by experience primarily driven by the B process (the “B state”) (see Figure 1.1).

In the case of cocaine administration, the immediate effects of the drug produce an initial “high” or euphoria in the A state, while the delayed effects of cocaine are marked by an anxiogenic, dysphoric B state. Solomon and Corbit (1974) conceived of these two states as being mediated by independent neuronal systems – one associated with the initial response of positive affect and the other with an opposing negative affect meant to bring the organism back to a hedonic baseline. They noted,

“...there are certain systems in the brain, the business of which is to suppress or reduce all excursions from hedonic neutrality” (Solomon & Corbit, 1974; pg 143)

In this context, it seems reasonable to hypothesize that the decision to seek and ultimately self-administer cocaine must take into account the dual and opposing subjective experiences produced by the drug. If so, then a full understanding of the factors that motivate organisms to ingest cocaine must include an identification of the mechanisms subserving not just the positive factors that motivate organisms to ingest cocaine, but also its negative and aversive features. It is, therefore, the overarching goal of the current dissertation to identify the underlying neurobiological mechanisms responsible for, or contributing to the opponent process “B” state – i.e., the negative, anxiogenic effects of cocaine.

1.3 The Runway Model of Self-Administration

In order to better study these dual and opposing effects of cocaine, the laboratory of Dr. Aaron Ettenberg developed a runway model of drug self-administration. This task is a modification of a classical behavioral paradigm, whereby animals are trained to run down a straight-arm alleyway and approach a goal box to seek an incentive stimulus (Crespi, 1942; Ettenberg, 2009; Hull, 1932, 1934a, 1934b). In these studies, the latency to leave the start box and the time required for the animal to enter the goal box serve as measures of the strength of approach behaviors. Thus, the animal must perform an operant behavior (i.e., run the length of the alley) in order to return to an environment that had previously been paired with drug administration. In this way the paradigm includes aspects of both an operant self-administration task (running for the drug reinforcer) and a conditioned place preference test (the development of drug-goal box associations).

The behavior of subjects running in an alleyway may be best explained by Miller's (1959) Theory of Conflict. According to this theory, an incentive stimulus (i.e., one possessing motivational impact) may either produce behavioral approach, avoidance, or a mixed approach/avoidance gradient dependent on the inherent or conditioned attributes of the goal stimulus.

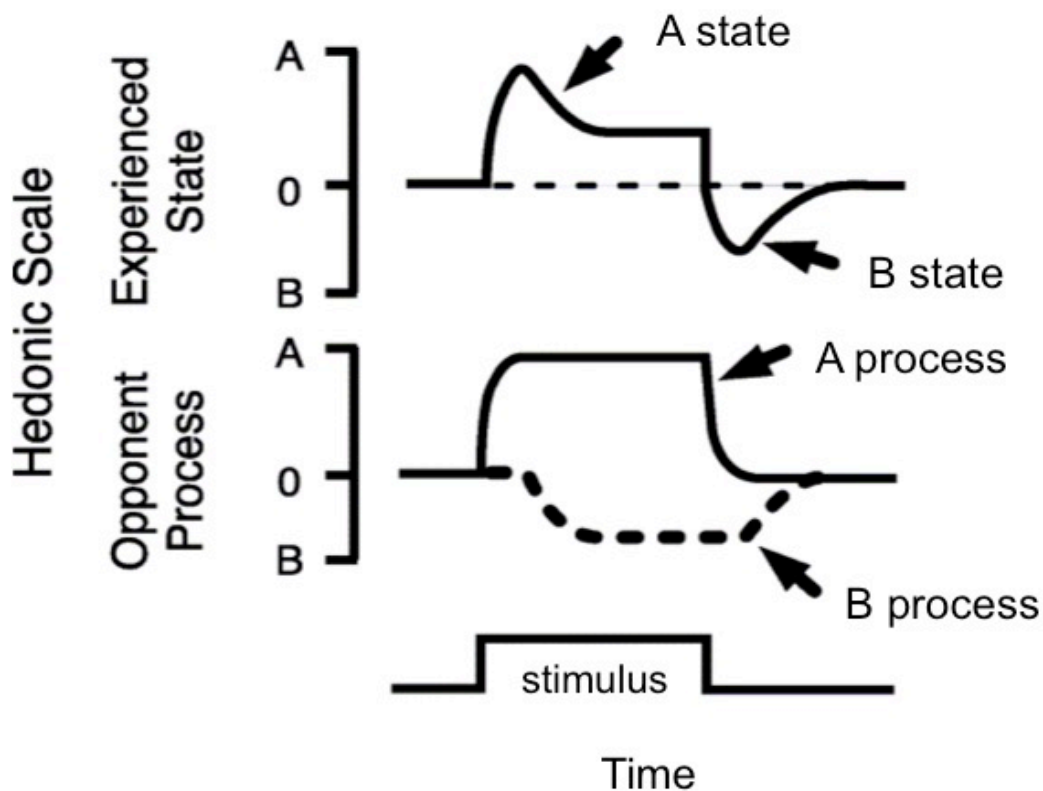

Figure 1.1. Schematic diagram of Solomon & Corbit’s “Opponent Process Theory of Motivation.” The bottom curve illustrates the opponent “A” and “B” processes. While the A process begins immediately following stimulus onset, quickly reaches an asymptote and then rapidly decays, the B process begins shortly *after* and in response to the A process, and decays more gradually, and remains in effect for a short time even after the stimulus is removed. The top curve illustrates the subjective experience of the organism produced by the stimulus – effectively a summation of both the A and B processes. As shown, immediately following stimulus onset an organism’s experience is that of the A state, which is above baseline on the ordinate hedonic scale. Following stimulus termination, the organism’s experience shifts to that of the B state – below baseline on the ordinate hedonic scale.

Miller postulated that if a stimulus is purely positive in nature, then the subjects' motivation to approach that stimulus will increase in strength as the subject nears the stimulus (an approach gradient). Likewise, for a stimulus that is perceived as purely negative in valence, the subjects' motivation to avoid that stimulus will grow with increasing proximity to that stimulus (an avoidance gradient). However, the increases in strength for approach and avoidance gradients are not equal. The asymptote for approach behavior towards a positive stimulus has been shown to occur at greater distances than that for the avoidance of a negative stimulus (Smith, 1960). Thus, when a stimulus possesses both positive and negative qualities (i.e. mixed properties), the animal will first initiate approach behavior, but, as it nears the stimulus, avoidance motivation increases and may eventually halt the forward approach altogether. The competition between these two gradients results in an approach-avoidance oscillatory behavior where animals will first progress toward, and then withdraw away from, the goal box (Geist & Ettenberg, 1997; Miller, 1944). Geist and Ettenberg (1997) labeled this back-and-forth response as "retreat" behavior, which develops in runway procedures using a goal box that is associated with a dual positive and a negative incentive stimulus, such as food + foot shock, or water + foot shock (Cohen, Young, Velazquez, Groysman, Noorbehesht, Ben-Shahar, & Ettenberg, 2009; Geist & Ettenberg, 1997; Martin & Ross, 1964; Miller, 1944). While the approach-avoidance retreat behavior may persist for some time, as long as the positive associations of the goal box are greater than the

negative associations, the animal will eventually choose to enter the goal box to retrieve the mixed incentive stimulus.

In our laboratory, this runway model has been adapted to examine drug self-administration. Here, animals traverse a straight alley once per day to enter a goal box where they receive a single intravenous (i.v.) injection of a drug reinforcer (Ettenberg, 2009; Geist & Ettenberg, 1990). Early on, it was noticed that rats trained to run for an i.v. injection of cocaine developed a unique pattern of responding that was not observed with other drug reinforcers (Ettenberg & Geist, 1993; Guzman & Ettenberg, 2004; Su, Wenzel, Baird, & Ettenberg, 2011). Cocaine-reinforced animals exhibited decreased start latencies (i.e. they leave the start box more and more quickly) over trials, demonstrating an increasing motivation to seek the drug and approach the goal. However, as the subjects experienced more trials (and gained more experience with the dual consequences of the drug), they began to exhibit progressively longer run times (it took them longer and longer to actually enter the goal box). This increase in run times was found to be a direct result of the increasing occurrence of the approach-avoidance “retreat” behaviors wherein rats rapidly approached the goal, but then stopped at the entry threshold, turned, and ran back towards the start box (Ettenberg & Geist, 1991). These retreats reflect the inherent conflict about goal box entry stemming from the mixed positive (reinforcing) and negative (anxiogenic) effects of cocaine administration that both eventually become associated with the goal box (for review, see Ettenberg, 2004), and can be mitigated

by pretreatment with various anxiolytic compounds (Ettenberg & Bernardi, 2006; Ettenberg & Geist, 1991; Guzman & Ettenberg, 2004; Knackstedt & Ettenberg, 2005). Consistent with Miller's Theory of Conflict (1944, 1959), the turning point in the alley where the animal stops and retreats away from the goal box is most frequently observed at the goal box threshold where the anxiety gradient is at its peak (Ettenberg & Geist, 1991; for review, see Ettenberg, 2009). Thus, the runway self-administration model provides a unique means of investigating both the positive and negative properties of cocaine *within the same animal on the same trial*.

The runway model has several additional strengths. Since cocaine is only administered at the termination of each trial and animals are tested only once per day, the protocol allows for the assessment of the subject's motivation to seek cocaine *prior to* drug delivery. This permits testing to be completely free from any direct confounding side effects of the drug reinforcer itself—e.g. sedative or stimulant motoric influences. The runway therefore serves as an excellent tool to distinguish between the motivation to seek cocaine and the reinforcing consequences of cocaine delivery. For example, in one study by Ettenberg and McFarland (2002), rats trained to run an alleyway for heroin reinforcement showed no changes in run times when pretreated with a dopamine (DA) or opioid antagonist drug, indicating a preserved motivation to reach the goal. However, once the animal reached the goal box and ingested the heroin under the influence of the antagonist treatment, the reinforcing properties of heroin were diminished. This was evidenced

by a significant reduction in subjects' motivation to approach the goal on the following day (Ettenberg & McFarland, 2002).

The ability to test operant behavior in an un-drugged state is a key difference between the runway model and traditional drug self-administration models. In typical operant box procedures, the initial drug injection will typically be followed by subsequent responding by the subject in order to obtain more drug. This behavior represents the motivation of an already drugged animal to maintain their desired level of intoxication. The distinction between motivated behavior in a drugged vs. un-drugged state is critical when investigating the dual properties of cocaine. Due to the bi-phasic effects of cocaine, all additional operant behavior after the initial infusion may in fact be motivated by the dual desire of the animal to experience cocaine's positive effects while also alleviating the onset of the drug's negative effects. Thus, subjects are likely not only responding for the positive effects of cocaine, but also for the negative reinforcing effects of the drug. This results in an inability to clearly distinguish between the positive and negative motivational influences in the traditional operant behavioral task. In contrast, the dissociation of the positive (start time) and negative (retreats) motivational components of drug seeking is relatively simple when utilizing a runway model of self-administration.

Of course, like all behavioral tests, the self-administration runway has its inherent weaknesses. The principal among these is the fact that, like the conditioned place test, the runway model of self-administration does not mimic the patterns of

drug use typically seen in humans. While the fact that this protocol requires only a single injection of drug per day allows for motivational testing to occur in the un-drugged state, it arguably does not model human drug use nor, therefore, meet the DSM-V criterion for substance abuse or dependence (American Psychiatric Association, 2013). Thus, if the primary goal of a research program is to model “addiction”, the runway model may not be the ideal behavioral task. One could, of course, first render the animal subjects “addicted” through the utilization of an alternative paradigm and then assess motivation to obtain the drug in the runway; a technique which has successfully been employed in our laboratory (Ben-Shahar, Posthumus, Waldroup, & Ettenberg, 2008). Lastly, the runway model places significant physical demands on the animals. In this test, rats are required to traverse an alleyway approximately six feet long to obtain the reinforcer, and the dependent variables measured are contingent upon the movement of the animal. Consequently, any manipulations that may alter locomotor ability or propensity to respond (e.g. systemic DA antagonist pretreatment) may compromise the interpretation of the runway measures. It is therefore necessary to assess the locomotor capacity of the subjects in interpreting the effects of chronic treatments (e.g. lesions) or pretreatments that may affect runway behavior.

1.4 Brain Systems Implicated in Anxiety

1.4.1 The Bed Nucleus of the Stria Terminalis (BNST)

As described above, cocaine produces a variety of psychological and physiological effects that can induce a state of anxiety in both humans and animals.

There are a few brain regions that appear well positioned to mediate and regulate the generation of cocaine-induced anxiety. One of these structures, located in what is now known as the “extended amygdala”, was first described by Johnston in 1923, when he noted that the "bed of the stria terminalis" forms a continuous forebrain structure, which includes both the centromedial portion of the amygdala as well as the adjoining nucleus accumbens (NAcc) (Johnston, 1923) (See Fig. 1.2 below).

Nearly half a century later, work by Heimer and colleagues advanced the concept of the extended amygdala as an anatomically and functionally interconnected system within the basal forebrain comprised of the bed nucleus of the stria terminalis (BNST), central nucleus of the amygdala (CeA), and a portion of the NAcc shell (Alheid & Heimer, 1988; Olmos & Heimer, 1999). This macrostructure receives its primary input from non-isocortical regions of the limbic system and sends prominent projections to autonomic and somatomotor centers of the lateral hypothalamus and brain stem as well as to the VTA and endocrine nuclei of the medial

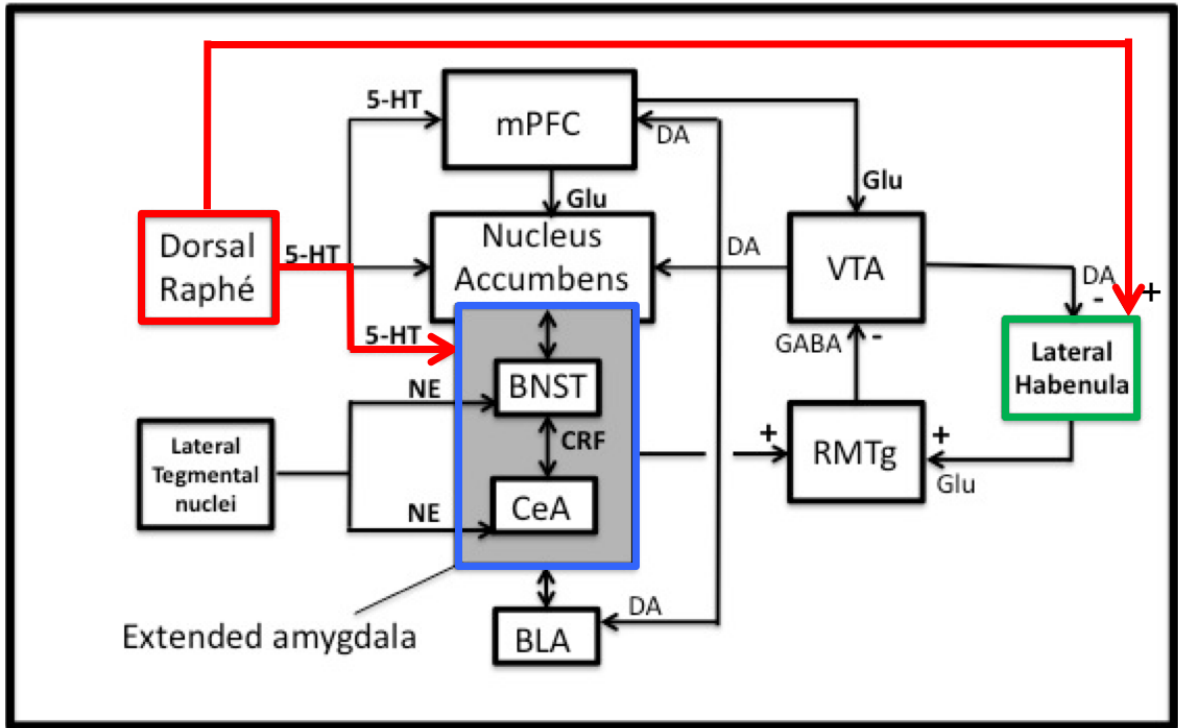

Figure 1.2. Schematic diagram of brain circuits involved with the positive and negative actions of cocaine. Major serotonergic pathways, emanating from the Dorsal Raphé Nucleus, that are investigated by this dissertation are highlighted in red. These pathways project to key regions that are strongly associated with stress, anxiety, and negative outcomes. The two under consideration by this work are the Bed Nucleus of the Stria Terminalis (BNST), or “Extended Amygdala”, in blue, and the Lateral Habenula (LHb) in green.

hypothalamus (Dong & Swanson, 2004; Heimer, 2003). Its position at the interface between limbic and autonomic, as well as the brain's motor systems, places the extended amygdala at an ideal neuroanatomical location to work as an integrator between incoming affective stimuli and their corresponding physiological and behavioral responses (Mogenson, Jones, & Yim, 1980). Indeed, much research has implicated the extended amygdala in the processing of stress-related stimuli and activation of the hypothalamic-pituitary-adrenal (HPA) axis (Herman, Figueiredo, Mueller, Ulrich-Lai, Ostrander, Choi, & Cullinan, 2003; Ulrich-Lai & Herman, 2009).

Within the extended amygdala, both the BNST and CeA have been shown to play a critical role in the experience of fear and anxiety states (Davis, 2006; Schweimer, Fendt, & Schnitzler, 2005). Fear is typically defined as a transient adaptive state of apprehension to an immediate threat, whereas anxiety is considered a future-oriented sustained mood state associated with potential threat (Davis, Walker, Miles, & Grillon, 2010). Historically, the CeA has been implicated in the production of fear states while activation of the BNST has been associated with anxiety. In support of this model, lesions of the CeA, but not the BNST, block fear-potentiated startle to a light cue previously paired with footshock (Hitchcock & Davis, 1986, 1991). Conversely, light-enhanced startle (a paradigm that exploits the unconditioned anxiogenic effects of bright light exposure in rodents) is blocked by infusion of the α -amino-3-hydroxy-5-methyl-4-isoxazole-propionate (AMPA) receptor antagonist NBQX into the BNST, but is not blocked when the same drug is

delivered to the CeA (Walker & Davis, 1997). These results are likely due to a differential involvement in short-duration versus sustained longer-duration fear responses between the CeA and BNST, respectively, rather than differences in the processing of conditioned versus unconditioned stimuli. To support this conclusion, Davis and colleagues (1989) utilized a conditioned fear paradigm in which seven randomly presented footshocks were delivered during a long-lasting (eight minute) auditory stimulus. Rats learned that during conditioned stimulus presentation they are at risk for shock, but they did not know exactly when that shock might occur. Following conditioning, intra-BNST AMPA antagonism decreased fear-potentiated startle later in the stimulus presentation (minutes 5–8) but not at the start of the conditioned stimulus (minutes 1–4)(Davis, Schlesinger, & Sorenson, 1989). This supports the notion that, although the CeA is involved in shorter duration fear states, the BNST plays a role in sustained fear, which may be better described as anxiety. What is clear, is that both regions of the extended amygdala play an important role in the physiological processing of stressful stimuli.

Aside from fear and anxiety states generated by external stimuli, both the CeA and the BNST have also been implicated in negative affective states resulting from drug withdrawal. Similar to the withdrawal-related dysphoria observed in human addicts (Gawin, 1986), animals exhibit heightened anxiety following cessation of repeated daily cocaine administration. In the first 24-48 hours following cocaine abstinence (after a period of chronic drug exposure), increased stress

responsivity can be observed in rodents as measured by an increase in the propensity to defensively bury a probe previously associated with footshock (Basso, Spina, Rivier, Vale, & Koob, 1999; Harris & Aston-Jones, 1993) or to avoid open spaces in an elevated plus maze (DeVries & Pert, 1998; Perrine, Sheikh, Nwaneshiudu, Schroeder, & Unterwald, 2008; Rudoy & Van Bockstaele, 2007; Sarnyai, Bíró, Gardi, Vecsernyés, Julesz, & Telegdy, 1995). Increased reactivity in these models is indeed correlated with activation of both the CeA and BNST (Gracy, 2001; Hamlin, Buller, Day, & Osborne, 2004; Jin, Araki, Nagata, Suemaru, Shibata, Kawasaki, Hamamura, & Gomita, 2003); moreover, antagonism of either area reduces withdrawal-enhanced anxiety behavior in these paradigms (Harris & Aston-Jones, 1993; Rudoy & Van Bockstaele, 2007; Sahuque, Kullberg, Mcgeehan, Kinder, Hicks, Blanton, Janak, & Olive, 2006).

In extended drug withdrawal (following 48 hours abstinence), animals continue to exhibit heightened responsivity to stressors, however, this appears to be the case only under conditions in which anxiety is activated by presentation of an aversive stimulus (e.g., the defensive burying paradigm) and not in situations where discrete stress-predictive stimuli are lacking (e.g., the elevated plus maze) (Erb, Kayyali, & Romero, 2006). Augmented stress reactivity may play a role in the increased likelihood for aversive stimuli to reinstate drug-seeking behavior following extended withdrawal (Shaham, Shalev, Lu, de Wit, & Stewart, 2003). In accordance with this idea, Sorge and Stewart (2005) found that in rats with a history of chronic

extended cocaine access, the ability of footshock stress to reinstate responding on a lever previously associated with cocaine delivery increased during progressive abstinence and remained robust after 60 days of withdrawal (Sorge & Stewart, 2005). Additionally, similar to what is seen during extended withdrawal, the extended amygdala has been implicated in stress-induced reinstatement of cocaine seeking (for review, see Erb, Shaham, & Stewart, 2001). Prior research from our own laboratory has highlighted the role of NE signaling within the extended amygdala as it relates to the anxiogenic effects of cocaine (Wenzel, Cotten, Dominguez, Lane, Shelton, Su, & Ettenberg, 2014; Wenzel, Waldroup, Haber, Su, Ben-Shahar, & Ettenberg, 2011).

Because of the strong link between the extended amygdala and the production of anxiety-like behaviors, the BNST was selected for this dissertation as one of the prime candidates for investigation into its role in mediating the anxiogenic effects of cocaine.

1.4.2. The Lateral Habenula

In recent years, another structure has come into focus in relation to the aversive actions of cocaine. The lateral habenula (LHb) is an epithalamic structure composed mainly of glutamatergic cell bodies that is highly conserved across vertebral species (Aizawa, Kobayashi, Tanaka, Fukai, & Okamoto, 2012; Lammel, Lim, Ran, Huang, Betley, Tye, Deisseroth, & Malenka, 2012; Li, Piriz, Mirrione, Chung, Proulx, Schulz, Henn, & Malinow, 2011; Stamatakis & Stuber, 2012; Stephenson-

Jones, Floros, Robertson, & Grillner, 2012; Sutherland, 1982). The LHb receives significant input from a wide variety of brain structures, including the globus pallidus, the lateral hypothalamus, hippocampus, prefrontal cortex, and the ventral pallidum via the stria medullaris (Herkenham & Nauta, 1977; Hong & Hikosaka, 2008; Velasquez, Molfese, & Salas, 2014). The LHb in turn projects through the fasciculus retroflexus to areas including the dorsal and median raphé nuclei, hypothalamus, locus coeruleus, and dorsal pontine central gray (Aghajanian & Wang, 1977; Araki, McGeer, & McGeer, 1984; Herkenham & Nauta, 1979; Hikosaka, Sesack, Lecourtier, & Shepard, 2008; Quina, Tempest, Ng, Harris, Ferguson, Jhou, & Turner, 2015; Sutherland, 1982). Although, many LHb connections may in fact be mediated through the rostromedial tegmental nucleus (RMTg) to which the LHb sends a significant projection (Hikosaka, 2010; Jhou, Geisler, Marinelli, Degarmo, & Zahm, 2009). According to Baker, Oh, Kidder, and Mizumori (2015), the afferent and efferent projections of the LHb give us significant insight into the role of the LHb. These investigators hypothesize that the LHb plays a vital role in behavioral flexibility, where it serves as a connection between the internal/external states of the organism and the midbrain areas subserving motivation and learning. In other words, Baker and colleagues (2015) suggest that the LHb takes in information about the current state of the organism, and passes that information along with the goal of altering behavior to gain rewards and avoid punishments (Baker, Oh, Kidder, & Mizumori, 2015). Indeed, with its projections to the dorsal and median raphé nuclei,

the locus coeruleus, and RMTg, the LHb is located in an ideal position to regulate and coordinate the release of all the major monoamine neurotransmitters (DA, 5-HT, and NE) throughout the brain (See Fig 1.2).

Disruption of the LHb might therefore be expected to impair an organism's ability to effectively and efficiently alter its behavior to changing circumstances.

Evidence for this type of disruption was shown in studies wherein rats with excitotoxic lesions of the LHb were unable to learn, maintain or switch behaviors in response to changing contingencies regarding appetitive rewards (Christoph, Leonzio, & Wilcox, 1986; Thornton & Davies, 1991; Thornton & Evans, 1984).

If the hypothesis put forth by Baker et al. (2015) regarding the role of the LHb in behavioral flexibility is indeed correct, then one would predict that the LHb should be particularly sensitive to aversive or harmful stimuli, as these outcomes require significant changes in behavior. In accordance with this view, it has been noted that not only do multiple afferents projecting to the LHb come from sources known to be associated with anxiety, but also that the LHb has been implicated in mediating the effects of anxiety, stress, and avoidance learning (Amat, Sparks, Matus-Amat, Griggs, Watkins, & Maier, 2001; Caldecott-Hazard, Mazziotta, & Phelps, 1988; Gao, Hoffman, & Benabid, 1996; Gottesfeld, 1983; Murphy, DiCamillo, Haun, & Murray, 1996; Stamatakis & Stuber, 2012). Indeed, a variety of studies have shown that the LHb exhibits increased neuronal activity under adverse conditions. In an experiment using fMRI imaging techniques with human subjects, Hennigan and colleagues found

that the lateral habenula is active during “punishment” trials where participants received mild foot shocks (Hennigan, D’Ardenne, & McClure, 2015). Activation of the LHb was also found to induce physiological signs of anxiety in rats, such as vasoconstriction and brown adipose tissue thermogenesis (Ootsuka & Mohammed, 2015). Likewise, under conditions of heightened anxiety, inactivation of the LHb decreases anxiogenic behaviors in rodents (Gill, Ghee, Harper, & See, 2013).

The LHb also appears to be necessary for the long-term storage of memories for adverse events. One study found that pharmacological inactivation of the LHb during aversion training in rats could lead to a loss of the memory seven days later, but not 24 hours later (Tomaiuolo, Gonzalez, Medina, & Piriz, 2014). This suggests that while the general memory of the animal remained intact regardless of the LHb inactivation, the subjective salience of the experience was altered in such a manner as to disrupt long-term storage of the memory.

While all these studies clearly implicate the LHb in the processing of aversive information, perhaps the most compelling study to demonstrate the link between the LHb and aversion learning was performed by Matsumoto and Hikosaka (2007). In their study, two monkeys were trained to perform a visual eye movement task wherein the animal had to make quick saccades to a target on screen. The targets signaled either a reward for correct response, or no reward. At certain time points the target meanings were switched, so that rewarded targets became non-rewarded, and vice versa. During these tasks, electrodes were placed in multiple

cells of both the LHb and midbrain dopamine neurons to record spiking activity. The recordings clearly showed that LHb neurons were more active during non-rewarded trials than during rewarded trials, again suggesting that the LHb is more active under adverse conditions, while the opposite was found for DA cells. However, the cells of the LHb showed the most robust responding during trials where the target meanings had been switched from signaling reward to non-reward. Here, the animals expected that the task would result in a reward, but no reward was earned. The difference between the expected rewarding outcome and the actual outcome of no reward caused significant increases in LHb activation. Matsumoto and Hikosaka (2007) refer to this as a “reward prediction error”, where an expected reward is omitted. Thus, it was under circumstances of reward prediction error that the LHb was found to be most active, an effect that has now been replicated in other studies and under different conditions (Bromberg-Martin & Hikosaka, 2011; Bromberg-Martin, Matsumoto, & Hikosaka, 2010; Matsumoto & Hikosaka, 2007, 2009; Tian & Uchida, 2015). Additionally, human neuroimaging studies of the LHb have similarly shown enhanced activity in response to reward prediction errors (Shepard, Holcomb, & Gold, 2006; Ullsperger & Cramon, 2003).

Activation of the LHb under these conditions also appears to be linked to inhibited DA release in the midbrain. When a reward prediction error occurs, the LHb is first found to increase its activity, and this is followed shortly thereafter by a silencing of the DA neurons of the VTA (Bromberg-Martin & Hikosaka, 2011;

Matsumoto & Hikosaka, 2007). The time-course of this activation and subsequent silencing of distinct neuronal populations is suggestive of a causal relationship between the two groups. Indeed, reciprocal connections have been found between the LHb and the VTA (Gruber, Kahl, Lebenheim, Kowski, Dittgen, & Veh, 2007; Jhou et al., 2013), and electrical stimulation of LHb inhibits VTA neurons (Christoph et al., 1986; Ji & Shepard, 2007). Inversely, studies utilizing pharmacological inhibition of LHb have found increased DA release in striatal neurons (Lecourtier, DeFrancesco, & Moghaddam, 2008). According to Stamatakis et al. (2013), these data suggest that, “LHb neurons encode negative reward prediction errors and may negatively modulate midbrain dopaminergic neurons in response to aversive events” (Stamatakis, Jennings, Ung, Blair, Weinberg, Neve, Boyce, Mattis, Ramakrishnan, Deisseroth, & Stuber, 2013).

Recent studies have proposed that this inhibition of midbrain DA neurons by the LHb may facilitate the onset of cocaine’s negative properties (Friedman, Lax, Dikshtein, Abraham, Flaumenhaft, Sudai, Ben-Tzion, Ami-Ad, Yaka, & Yadid, 2010; Jhou, Fields, Baxter, Saper, & Holland, 2009), as lateral habenular function is also affected by exposure to drugs of abuse. For example, direct application of cocaine to the LHb results in increases in neuronal activation within this region (Zuo, Chen, Wang, & Ye, 2013). The mechanism through which the LHb modulation of DA occurs is thought to be via a region called the the rostro-medial tegmental nucleus (RMTg), which sits adjacent to, and is a major source of inhibitory GABAergic projections

onto the VTA (Balcita-Pedicino, Omelchenko, Bell, & Sesack, 2011; Jhou, Fields, et al., 2009; Jhou, Geisler, et al., 2009). Thus, activation the LHb is believed to inhibit the VTA via glutamatergic activation of the RMTg, which in turn inhibits cell firing within the VTA (Good, Wang, Chen, Mejias-Aponte, Hoffman, & Lupica, 2013; Jhou, Fields, et al., 2009; Jhou, Geisler, et al., 2009; Kowski, Veh, & Weiss, 2009; Omelchenko, Bell, & Sesack, 2009). This may then be the first step in “turning off” the initial reward signals produced by DA cells within the VTA, thereby unmasking the underlying negative effects of cocaine (or, for Solomon & Corbitt, the “B” process).

To complete the circuit, it has now been demonstrated that DA cells within the VTA themselves project back to the LHb (Gruber et al., 2007; Phillipson & Griffith, 1980; Skagerberg, Lindvall, & Björklund, 1984), potentially forming a negative-feedback loop through which the encoding of both appetitive and aversive information can interact and restore a homeostatic balance. Indeed, Jhou et al. (2013) has shown that a subset of LHb neurons exhibit biphasic responses to i.v. cocaine with an initial inhibition (thereby decreasing the LHb-RMTg inhibition of the VTA and permitting the reward signal to predominate) followed by a delayed excitation whose timing parallels cocaine’s shift from rewarding to aversive (Ettenberg, 2004; Ettenberg et al., 1999; Jhou et al., 2013).

Although much of the research on the LHb has been focused on its connection and relationship with the RMTg/VTA DA system, including work from our

own laboratory that explored the role of Dopamine-D₄ receptors in the LHb (Shelton, Bogyo, Schick, & Ettenberg, 2016), it has also long been known that the habenula has prominent reciprocal projections to both the dorsal (DRN) and median (MRN) raphé nuclei of the brainstem (Lidov & Molliver, 1982; Luo, Zhang, Li, Yang, Sun, & Zhao, 2015; Metzger, Bueno, & Lima, 2017). Recent anatomical investigations of this region have revealed that it is the medial portions of the LHb that receive direct serotonergic innervation, and in turn send projections to acetylcholine- (ACh), DA- and serotonin- (5-HT) releasing cells of the midbrain and hindbrain. While it is the more lateral portion of the LHb that synapse on the GABA-ergic cells of the RMTg, which in turn exerts inhibition upon both the DA cells of the VTA, as well as on serotonergic cells located in both the dorsal and median raphé nuclei (Metzger et al., 2017). Thus, the LHb is in a prime position to regulate the brain serotonergic system through both direct and indirect pathways.

The precise neuronal mechanism by which this region mediates the anxiogenic response to cocaine remains under investigation, and forms the basis of this dissertation's investigation into the role of 5-HT in the LHb and its involvement in the aversive effects of cocaine.

1.5 Cocaine and Serotonin (5-HT)

The neuropharmacological actions of cocaine are predominately mediated by the drug's inhibitory action at the monoamine transporters: DAT, NET, and SERT, respectively. Although cocaine is traditionally thought of as a prototypical DA

reuptake inhibitor, it actually has approximately equal affinity for all three monoamine transporters, and if anything, is *slightly* more selective at 5-HT than DA or NE synapses (Cunningham, Paris, & Goeders, 1992a, 1992b; Filip, Alenina, Bader, & Przegaliński, 2010; Walsh & Cunningham, 1997). Additionally, 5-HT has been strongly linked to the development and expression of anxiety-like behavior (Abrams, Johnson, Hay-Schmidt, Mikkelsen, Shekhar, & Lowry, 2005; Sena, Bueno, Pobbe, Andrade, Zangrossi, & Viana, 2003; Watson & Man, 2000), making serotonin a prime candidate to investigate in the anxiogenic effects of cocaine. Consistent with this hypothesis are prior studies from our own laboratory demonstrating that inactivation of 5-HT cell bodies in the DRN (Ettenberg, Ofer, & Mueller, 2011) and systemic treatment with the 5-HT_{1A} partial agonist, buspirone (Ettenberg & Bernardi, 2006), reduced the development of approach/avoidance “retreat” behavior in the runway model of cocaine self-administration. Using a Conditioned Place Preference/Conditioned Place Aversion (CPP/CPA) paradigm, buspirone was also effective at selectively diminishing the delayed aversive effects of the drug, while leaving the initial positive effects intact (Ettenberg & Bernardi, 2007).

The BNST receives dense serotonergic innervation from the dorsal raphe nucleus (See Fig 1.2) and expresses multiple inhibitory and excitatory 5-HT receptor subtypes (Guo, Hammack, Hazra, Levita, & Rainnie, 2009; Hammack, Guo, Hazra, Dabrowska, Myers, & Rainnie, 2009; Hazra, Guo, Dabrowska, & Rainnie, 2012). Of particular interest is the 5-HT_{1B} autoreceptor, whose activation serves to decrease 5-

HT release from the pre-synaptic serotonergic cell at the synapse (Adell, Celada, & Artigas, 2001; Sari, Lefèvre, Bancila, Quignon, Miquel, Langlois, Hamon, & Vergé, 1997). Whole-tissue samples of BNST show relatively high levels of expression of 5-HT_{1B} mRNA, whereas single cells from the same region do not express this transcript (Guo et al., 2009). These findings indicate that 5-HT_{1B} receptors within the BNST are likely localized presynaptically and so manipulations targeted at these receptors should be selective to 5-HT projections into the BNST.

In vitro experiments to assess the neuronal response of BNST cells to serotonin have shown that this region has a heterogenous response, with some neurons hyperpolarizing, some depolarizing, and yet another group that had a mixed response with an initial hyperpolarization followed by depolarization (Hammack et al., 2009). In the very same study, the authors demonstrated that chronic stress changes the overall profile from one that favors an inhibitory response to 5-HT, towards one where 5-HT produces excitation. They note the potential implications for anxiety and propose a model where under normal conditions, 5-HT release in the BNST is inhibitory, which serves to decrease anxiety. However, in animals exposed to chronic stress, the receptor expression profile changes to favor excitation, turning what was a negative feedback loop with the DRN into a positive feedback loop, that turns an anxiolytic circuit into an anxiogenic one (Hammack et al., 2009). For this dissertation, it is hypothesized that much like the effects of chronic stress, chronic

exposure to cocaine will also shift the BNST response to 5-HT from being primarily anxiolytic to primarily anxiogenic.

Similar to the BNST, the LHb also expresses a wide variety of 5-HT receptors, including the 5-HT₁, 5-HT₂, 5-HT₃, 5-HT₅, and 5-HT₇ families (Metzger et al., 2017). Again, the current dissertation focuses in particular on the presence of inhibitory 5-HT_{1B} receptors in the LHb (Tchenio, Valentinova, & Mameli, 2016; Wagner, Bernard, Derst, French, & Veh, 2016; Wagner, French, & Veh, 2016). The 5-HT_{1B} receptor is an inhibitory Gi-coupled receptor that is primarily located on axon terminals as an auto- or hetero-receptor (Boschert, Ait. Amara, Segu, & Hen, 1994). Therefore, by targeting the 5-HT_{1B} autoreceptors with a selective 5-HT_{1B} agonist, it should be possible to decrease the cocaine-induced 5-HT release with local infusion of the drug. Indeed, microdialysis studies have demonstrated that local application of a 5-HT_{1B} agonist into the LHb is capable of decreasing 5-HT release (Adell et al., 2001). Additionally, systemic treatment with 5-HT_{1B} agonists has been shown to produce anxiolytic-like effects across multiple behavioral tests (Chojnacka-Wojcik, Klodzinska, & Tatarczynska, 2005; Tatarczynska, 2004), which further supports the hypothesis that this receptor represents an ideal target to modulate the anxiogenic response to cocaine.

The 5-HT response of neurons in the LHb is complex, and still not completely understood. A recent review by Metzger, Bueno, and Lima (2017) gives an in-depth overview of the relationship between serotonin and the LHb. Briefly, they describe

how the LHb has two major outputs that can regulate the brain 5-HT system: one, originating in the medial LHb that directly innervates the DRN, and a second indirect pathway, from the lateral LHb that can modulate the DRN/MRN indirectly via activation of GABAergic cells of the RMTg (Metzger et al., 2017). They also note the existence of a reciprocal connection from the DRN/MRN back to the LHb. However, this serotonergic pathway does appear to restrict its projections to only the medial subsection of the LHb, as well as the medial habenula, with only a very sparse labeling of 5-HT stained fibers in the more lateral regions. The authors also make note of the implications for a potential dysfunction in this circuitry to be involved with the pathophysiology of anxiety and depression (Metzger et al., 2017).

The LHb has also been implicated in the aversive effects of cocaine. As referenced above, the study by Jhou and colleagues (2013) showed that cocaine produces a biphasic response in LHb neurons, with an initial hyperpolarization, followed by a delayed depolarization. They also found that by using optogenetic inhibition to silence the LHb 10-20 mins following cocaine administration, they could block the emergence of approach-avoidance retreat behavior, using a very similar runway model of self-administration to the one described in this thesis (Jhou et al., 2013). This study provides further evidence in support of the previously described “Opponent Process Theory” by Solomon & Corbitt (1974), which postulates that any affective response will be followed shortly after with an opposite opponent process to bring the organism back to a homeostatic baseline. Additionally, this experiment

further implicates the lateral habenula as having a major role in mediating the delayed aversive effects of cocaine.

1.6 Specific Aims

It is evident that cocaine produces an initial rewarding state of euphoria, followed shortly after by an anxiogenic, dysphoric “crash” in both animals and humans. While the positive effects of cocaine have been thoroughly studied over the decades, much less attention has been directed at understanding the drug’s negative effects. Cocaine is known to have potent effects on the brain’s 5-HT systems, which have been strongly implicated in disorders involving anxiety and depression. Thus, the overarching goal of this dissertation was to better understand the relationship between cocaine and 5-HT vis-a-vis cocaine’s negative anxiogenic actions, with a focus on the BNST and LHb -- two brain regions that have recently come into focus as potential targets for understanding the aversive effects of the drug. With that in mind, using intracerebral pharmacological manipulation of 5-HT release and the application of selective 5-HT lesions, the research described herein was devised to assess the role of 5-HT within these two brain regions – BNST and the LHb -- in contributing to the anxiogenic effects of cocaine. The results of this research were intended to add important insights into the role of 5-HT in mediating the well-known, but often ignored, anxiogenic effects of self-administered cocaine.

Chapter 2. General Methodology

2.1 Subjects

Subjects for all experiments were adult male albino Sprague-Dawley rats weighing approximately 275-300g at the time of surgery. Rats were obtained from Charles River Laboratories (Hollister, California, USA) and were pair-housed in hanging plastic cages within a temperature-controlled (23° C) vivarium maintained under a reverse 12-hour light-dark cycle (lights off at 0800h). Animals were provided *ad libitum* access to food (Purina Rat Chow) and water throughout the duration of each experiment. All animal handling and procedures adhered to the NIH *Guide for the Care and Use of Laboratory Animals* and were reviewed and approved by the University of California at Santa Barbara's Institutional Animal Care and Use Committee.

2.2 Surgical Procedures

Each subject was deeply anesthetized with an intramuscular injection of ketamine and xylazine (56.25 and 7.5 mg/kg, respectively; Abbott Laboratories) and fitted with an indwelling intravenous (i.v.) catheter (13 mm of microrenathane tubing, 0.014 mm inner diameter, 0.33 mm outer diameter; Braintree Scientific) inserted into the right jugular vein, secured in place by silk sutures, and subcutaneously (s.c.) passed to a threaded guide cannula (catalog #313G; Plastics One) that exited through a 2 mm hole on the animal's back. The guide cannula was cemented to a 3.0 cm square piece of Mersiline mesh (Bard; Warwick, RI) that was laid flat subcutaneously on the animal's back where it was secured with surgical

glue. While still anesthetized, each rat was then fitted with bilateral intracranial guide cannulae (22 gauge, 9 mm; Catalog #313GA/SPC; Plastics One) stereotaxically aimed 1.0 mm above the targeted brain region, using coordinates derived from the brain atlas of Paxinos and Watson (2007). The coordinates used for intracerebral cannula implantation were as follows: relative to bregma, AP -0.4, ML \pm 3.5, and DV -6.2 from skull surface with a lateral inclination of 15° for the BNST, and AP -3.4, ML \pm 1.5, and DV -3.2 from skull surface with a lateral inclination of 11° for the LHb (Paxinos & Watson, 2007). During surgery, subjects received the non-opiate analgesic meloxicam, (2.0 mg/kg s.c. at a concentration of 5.0 mg/ml in saline) to control for post-surgical pain in addition to buprenorphine HCl (0.05 mg/kg, 0.3 mg/ml), and saline for rehydration (3.0 ml s.c.). The catheters were flushed with the antibiotics cefazolin + gentamycin (0.25 ml of 1 mg/ml & 5.0 mg/ml, respectively) to prevent infection and heparinized saline (6.25 IU, 0.1 ml i.v.) to retain patency.

After surgery, catheter patency was maintained via daily flushing with 0.1ml cefazolin and gentamycin (1.0 mg/ml & 5.0 mg/ml, respectively) followed by 0.1 ml of heparinized 0.9% physiological saline. Animals were allowed to recover for at least 7 days prior to behavioral testing. Catheter patency was periodically assessed through observation of the loss of the righting reflex following an i.v. injection of the fast-acting barbiturate, methohexital (brevital, 2.0 mg/kg/ 0.1 ml). Rats that were unresponsive to brevital prior to the start of behavioral testing were re-implanted with a new catheter using the left jugular vein and given additional days for

recovery. Catheter patency failure during the course of behavioral testing resulted in subject removal from the data analysis.

2.2 Apparatus

2.2.1 Runway Model of Drug Self-Administration

Most experiments described in this dissertation employed the Runway Model of Cocaine Self-Administration, as previously described in Chapter 1 (section 1.4). Experiments took place in two identical wooden straight arm runways that were custom built for rodent drug self-administration (See Fig 2.1). As originally described by Geist and Ettenberg, (1990), each apparatus measured 155 cm (L) × 15 cm (W) × 40 cm (H). On opposite ends of the straight alley were identically sized start and goal boxes (each measuring 24 cm × 25 cm × 40 cm), each separated from the middle runway section of the apparatus by retractable doors. Along the interior length of the alley were 13 infrared photodetector- emitter pairs positioned in the walls 16 cm apart from one another. Input from these photocells was fed through an Any-Maze interface (Stoetling) to a laptop computer running AnyMaze software, which recorded the subjects' location in the runway in real time throughout each trial. Along the top of the alley were two magnetic rails that ran the entire length of the apparatus. These rails were aligned such that their polarity would repel a small circular disk magnet that is attached to a flow-through swivel (Instech), mounted within a circular doughnut-shaped piece of plastic that prevented the swivel from falling through between the rails. The opposing polarities of the rail magnets and the

magnet affixed to the plastic holder kept the entire swivel device floating a few cm above the rail surface (see Figure 2.1). This magnetically levitating swivel design allowed an animal to be tethered to a syringe pump for drug infusion, while permitting free movement throughout the apparatus with little to no friction impeding performance.

2.2.2 Locomotor Activity Chambers

Locomotor behavior (total distance traveled, cm) was measured in 12 identical Plexiglas chambers each measuring 20 cm (L) × 40 cm (W) × 20 cm (H) (Kinder Scientific). Each test chamber was equipped with an array of fifteen infrared photodetector-emitter pairs evenly spaced along its long axis and seven along its narrow axis, all 8 cm above the floor surface. Movement within the chamber produced photobeam interruptions that were recorded by a desktop computer running Motor Monitor software (Kinder Scientific).

2.3 Drugs

Cocaine hydrochloride (provided by the National Institute on Drug Abuse) was dissolved in 0.9% physiological saline and sterile filtered through a 0.22 µm filter (ThermoScientific). Cocaine was diluted to a dose of 1.0 mg/kg delivered in a volume of 0.1 ml over a period of 4.6 s via a 10 ml syringe nested in a motorized syringe pump (Razel Scientific Instruments). The dose of 1.0 mg/kg i.v. cocaine was chosen based upon the results of previous runway work from our laboratory (Ettenberg,

2004; Ettenberg & Bernardi, 2006; Raven, Necessary, Danluck, & Ettenberg, 2000; Wenzel et al., 2014, 2011).

The 5-HT_{1B} agonist CP 94,253 dihydrochloride (Sigma- Aldrich) was prepared in a vehicle solution of aCSF (l-ascorbic acid 0.35 g/L, NaCl 8.47 g/L, KCl .20 g/L, MgCl₂ .20 g/L, CaCl₂ .18 g/L, NaH₂PO₄ .276 g/L, Na₂HPO₄ .5362 g/L) for intracranial infusion. The drug CP 94,253 was selected because it shows the greatest affinity for 5-HT_{1B} over other receptors in the 5-HT₁ family (Koe, Nielsen, Macor, & Heym, 1992), and has produced behavioral effects in prior studies using intracranial administration at comparable doses (De Almeida, Rosa, Santos, Saft, Benini, & Miczek, 2006; Veiga & Miczek, 2007).

In order to demonstrate receptor specificity, the 5-HT_{1B} antagonist NAS-181 was selected due to its high affinity for the 5-HT_{1B} receptor and ability to block agonist binding (De Groote, Klomp makers, Olivier, & Westenberg, 2003; De Groote, Olivier, & Westenberg, 2002; Stenfors, Yu, & Ross, 2000). This drug was prepared in the same vehicle and co-infused with 5-HT_{1B} agonist.

For lesion studies, the compound 5,7-Dihydroxytryptamine (5,7-DHT; Adipogen) was infused once at a dose 8.0 µg/µl/side. This regimen is known to be selectively neurotoxic to serotonergic cells, provided animals are pretreated with

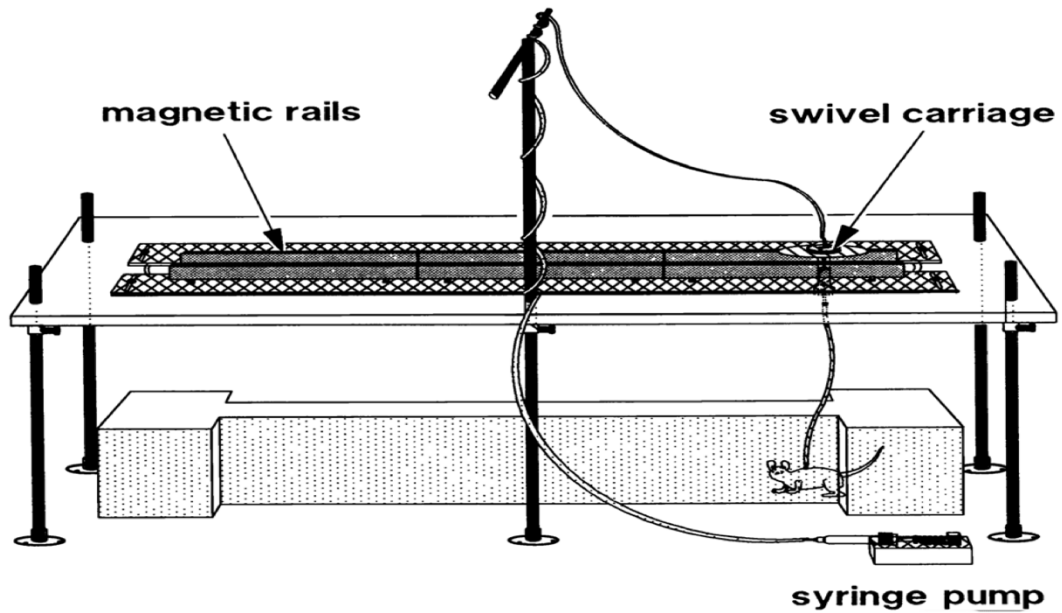

MAGNETIC SWIVEL CARRIAGE

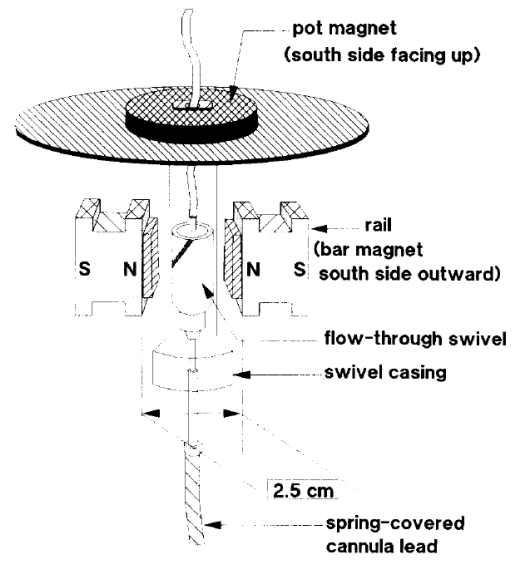

Figure 2.1 Schematic diagram of the runway self-administration apparatus and the flow-through swivel assembly. From Geist and Ettenberg (1990).

25.0 mg/kg desipramine to prevent 5,7 DHT uptake into NE neurons (Fletcher, Korth, & Chambers, 1999; Izumi, Ohmura, Futami, Matsuzaki, Kubo, Yoshida, & Yoshioka, 2012; Macedo, Castilho, de Souza e Silva, & Brandão, 2002; Nelson, Thur, Marsden, & Cassaday, 2012).

2.4 General Procedures

For an overview of the experimental timeline, see Fig 2.2.

2.4.1 Runway Testing

Prior to the first cocaine-reinforced trial, subjects were individually placed into the start box and permitted to freely explore the runway for 10 min to allow for acclimation to the apparatus (the goal door remained closed to prevent entry into the goal box). The first of 16 single daily runway trials began the following day. During each trial, subjects were connected to the drug delivery system and placed into the start box where, after 5 s, the start door was opened and the trial initiated. Upon entry into the goal box, the goal door was (to prevent retracing) and an i.v. infusion of 1.0 mg/kg cocaine (in 0.1 ml over 4.6 s) was administered. After 5 min, subjects were removed from the goal box and returned to their home cages. On the rare occasion that an animal did not enter the goal box within 10 min, it was gently encouraged (pushed from behind) to enter the goal box, where it then received an i.v. injection of cocaine. All trials for a given subject were conducted in the same apparatus. To maintain catheter patency, animals were flushed with 0.1 ml of

cefazolin/gentamycin followed by 0.1 ml heparinized saline after removal from the apparatus.

2.4.2 Locomotor Testing

To ensure that central manipulations did not produce nonspecific alterations in the response capacity of the subjects, they were examined in a test of spontaneous locomotor activity following completion of runway testing. At the start of testing, all animals were allowed to acclimate to the locomotor chambers for 60 min. Rats were then removed from the test chambers, administered the same bilateral microinjections that they had received previously during runway testing, and immediately returned to the locomotor chambers for an additional 15-min test session.

2.4.3 Serotonin 5-HT_{1B} agonist/antagonist treatments

For these experiments, animals received intracranial microinfusions prior to each of the 16 daily trials in the runway. The infusions were administered slowly over 120 s using a 25 µl Hamilton syringe that was seated in a motorized syringe pump (KD Scientific). The syringe was connected via PE20 tubing to 28-gauge internal cannula (catalog #313LI/SPC Plastics One) that, when inserted into the implanted intracranial guide cannula, projected 2 mm beyond the tip of the guide cannula. The internal cannula were left in place for 60 s post-infusion to permit diffusion of the drug away from the injection tip. Seven minutes after the infusion cannula was removed, each subject was moved to the runway apparatus, connected

Experimental Timeline

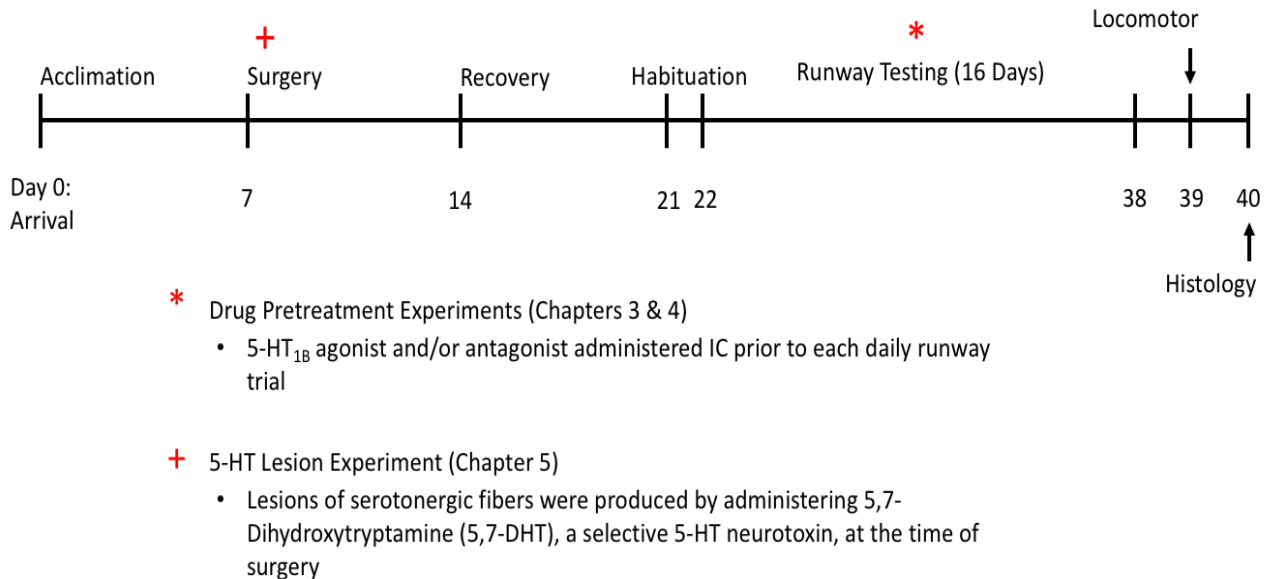

Figure 2.2 Experimental Timeline

After arrival in the vivarium, animals were acclimated for one week with daily handling before beginning the experiment. During week 2 animals underwent surgery for implantation of IC cannula, or 5-HT lesion (red +), and were allowed a full week to recover before their first trial. Prior to the first day of testing, animals had one habituation trial in the runway, followed by 16 days of testing. Animals in the drug treatment experiments (red *) were administered an intracranial pretreatment 10 mins prior to the start of testing on each day during the 16-day period. Locomotor behavior was assessed 24 hours after the last runway trial. After that, animals were euthanized and their brains collected for histological analysis.

to the i.v. drug delivery system, and placed into the start box where, after 5 s, the start door was opened and the trial initiated.

2.4.4 Serotonin-selective Neurotoxic Lesion Treatment

Animals participating in the 5-HT neurotoxic lesion experiments were administer an intracranial treatment of either the 5-HT neurotoxin 5,7-DHT or vehicle, on only one single occasion- during surgery. Since subjects each received a single infusion, they were not fitted with internal cannula. The intracranial infusion was delivered while the animal was under anesthesia for the catheter surgery, using the same stereotaxic surgical procedures and coordinates described above, except that the cannula was removed after the infusion and the animals were then allowed to recover. Infusions were delivered in a volume of 1.0 μ l over 5 mins (left in place an additional 2 mins to allow drug diffusion away from the cannula tip).

Since these animals did not require microinjections prior to each of the runway trials, the procedure for these experiments began with each animal simply being removed from its home cage, their catheters flushed with saline to clear any blockages, and then placed in the runway apparatus for testing. All testing parameters for these animals were identical to those described for the pharmacological manipulations.

2.5 Histology

After completion of behavioral testing, animals were euthanized with an overdose of sodium pentobarbital and phenytoin sodium solution (Euthasol; Virbac)

and perfused through the heart with 120 mL phosphate-buffered saline (PBS) followed by 120 mL 4% paraformaldehyde (PFA) in PBS. Brains were removed and post-fixed in 4% PFA, after which cannula placements were determined from Nissl-stained 40 μm frozen coronal sections. Subjects were excluded from analysis if there was sufficient evidence of necrosis at the injection site, or if the injection site landed outside the targeted region. These exclusions were determined by a trained observer blind to the treatment conditions of the animals.

**Chapter 3. Cocaine, Serotonin, and the Bed Nucleus of the Stria Terminalis
(BNST)**

3.1 Introduction

The current experiment employed the self-administration runway detailed in Chapter 2 to examine the role of serotonin release within the BNST in subserving cocaine's negative/anxiogenic effects. As described in Chapters 1 & 2, animals running an alley once a day for i.v. cocaine quickly approach, but then stop at, the goal box entryway and retreat back toward the start box (Ettenberg & Geist, 1991, 1993). As described in Chapter 1, this unique pattern of "retreat" behavior has been shown to reflect an approach-avoidance conflict stemming from mixed positive (rewarding) and negative (anxiogenic) associations with the cocaine-paired goal box (Ettenberg & Geist, 1991; Ettenberg et al., 1999; Geist & Ettenberg, 1997; Guzman & Ettenberg, 2007; see reviews by Ettenberg, 2004, 2009). As again described in Chapter 1, The BNST contains serotonergic synapses (Freedman & Shi, 2001; Guo et al., 2009; Hammack et al., 2009; Hazra et al., 2012), where cocaine acts to inhibit the activity of the presynaptic transporter thereby enhancing the impact of 5-HT release at the synapse (Filip et al., 2010; D. D. Han & Gu, 2006; Müller & Huston, 2006; Reith, Meisler, Sershen, & Lajtha, 1986). Additionally, the BNST shows elevated levels of the stress neuropeptide CRF in response to cocaine (Kash, Pleil, Marcinkiewicz, Lowery-gionta, Crowley, Mazzone, Sugam, Hardaway, & Mcelligott, 2015), is responsive to negative emotional and anxiogenic stimuli (Adhikari, 2014; Davis, 2006; Kim, Adhikari, Lee, Marshel, Kim, Mallory, Lo, Pak, Mattis, Lim, Malenka, Warden, Neve, Tye, & Deisseroth, 2013; Ventura-Silva, Pêgo, Sousa, Marques,

Rodrigues, Marques, Cerqueira, Almeida, & Sousa, 2012), and has been implicated in the aversive effects of cocaine withdrawal (Erb, 2010; Koob, 2008). The goal of the present experiment was, therefore, to investigate the functional role of 5-HT signaling within the BNST in modulating the negative/aversive actions of cocaine by examining the development of cocaine-induced approach–avoidance retreat behaviors in animals treated with a 5-HT_{1B} auto-receptor agonist.

3.2 Materials and Methods

3.2.1 Subjects

The subjects were 127 male Sprague-Dawley rats, with housing and living conditions as described in Chapter 2.

3.2.2 Surgery

Surgical procedures were performed as outlined in Chapter 2. Briefly, rats were fitted with both an i.v. jugular catheter and bilateral intracranial guide cannula aimed just above the BNST.

3.2.3 Drugs

The drugs employed in this experiment were: cocaine hydrochloride (1.0 mg/kg i.v.) served as the reinforcer in the runway test, the effects of which were examined after pretreatment with the 5-HT_{1B} auto-receptor agonist CP 94,253 dihydrochloride, (0.25, 0.5, or 1.0 µg/0.5 µl i.c.). Significant effects of the agonist were then challenged by co-administration of the agonist plus the selective 5-HT_{1B}

antagonist NAS-181 (0.0, 0.1, or 1.0 µg/0.5 µl i.c.). All the drugs were prepared and administered as described in Chapter 2.3.

3.2.4 Procedures

Subjects were acclimated to the apparatus on a single non-reinforced trial for 10 min after which (i.e., the next day), the first of 16 single daily runway trials was initiated (see Fig 2.2 for the experimental timeline). Three separate experiments were performed: in Experiment I, CP 94,253 was delivered as a pretreatment (10 min prior to each runway trial); Experiment II was conducted in the same manner, except CP 94,253 was delivered as a post-treatment (5 min *after* each runway trial); and in Experiment III the behavioral effects of the agonist drug were challenged by co-administration of the selective 5-HT_{1B} antagonist, NAS-181.

In Experiment I, the subjects were administered bilateral intra-BNST infusions of one of three doses of CP 94,253 or vehicle prior to each runway trial. Animals were free to traverse the runway to earn an i.v. infusion of cocaine upon goal box entry. On the rare occasion that an animal did not enter the goal box within 10 min, it was gently encouraged (pushed from behind) to enter the goal box, where it then received cocaine. All trials for a given subject were conducted in the same apparatus. To maintain catheter patency, animals were flushed with 10 mg/0.1 ml timentin followed by 0.1 ml heparinized saline after removal from the apparatus.

Since the anxiogenic effects of i.v. cocaine appear to peak at 15-min post-injection (Ettenberg et al., 1999; Jhou et al., 2013; Knackstedt et al., 2002), it was

important to examine the impact of CP 94,253 in the BNST after the subjects had experienced the initial rewarding effects of the cocaine but before the onset of the drug's anxiogenic actions—hence the treatment in Experiment II was applied 5-min post-cocaine. Animals first ran to and entered the goal box where they earned an i.v. injection of cocaine, and then were removed (after 5 min) and administered either 0.0 or 1.0 μg CP 94,253.

Experiment III was conducted to demonstrate the selectivity of the agonist's effects to the 5-HT_{1B} receptor. In this protocol, 10 min prior to each runway trial, animals were provided intra-BNST bilateral infusions of either the vehicle solution alone, or a 0.5 μg dose of the 5-HT_{1B} agonist, CP 94,253, co-administered with either one of the three doses of the selective 5-HT_{1B} antagonist NAS-181. Both drugs were administered in the same microinjection after which the runway testing was accomplished as previously described. In all experiments, three dependent measures were recorded on every trial. "Start latency"—the time required for the animal to leave the start box once the start door was opened; "Run Time"—the time required for the animal to enter the goal box after it had left the start box; and "Retreats"—the number of times an animal halted its forward motion and retreated back toward the start box by the length of at least two photodetector-emitters (i.e., approximately 32 cm).

3.2.5 Histology

As described in Chapter 2, upon completion of each experiment, animals were euthanized and their brains removed, sliced, stained and examined under magnification to confirm the location of the cannula placements.

3.3 Results

3.3.1 Histology

A subject's inclusion in the study required strict histological confirmation of bilateral placements directly above the target brain areas under investigation (see Fig. 3.1). A total of 44 animals successfully completed Experiment I, an additional 16 rats completed Experiment II and 33 animals were used in Experiment III.

Histological analyses identified 16 animals whose cannula placements required removal from the study; six had one or more cannula located within the lateral ventricles and four (not pictured in Fig. 1) as their cannula were located in regions posterior to the data visualized. An additional six animals were found to have evidence of necrosis around the injection site and were also removed from the data analyses.

Of the 16 animals in the anatomical control group, n=6 had one or more cannula located within the lateral ventricles and n=4 are not pictured in Fig. 1 as their cannulae were located in regions posterior to the data visualized. Additionally, six animals that were found to have evidence of necrosis around the injection site and were also removed from the data analyses.

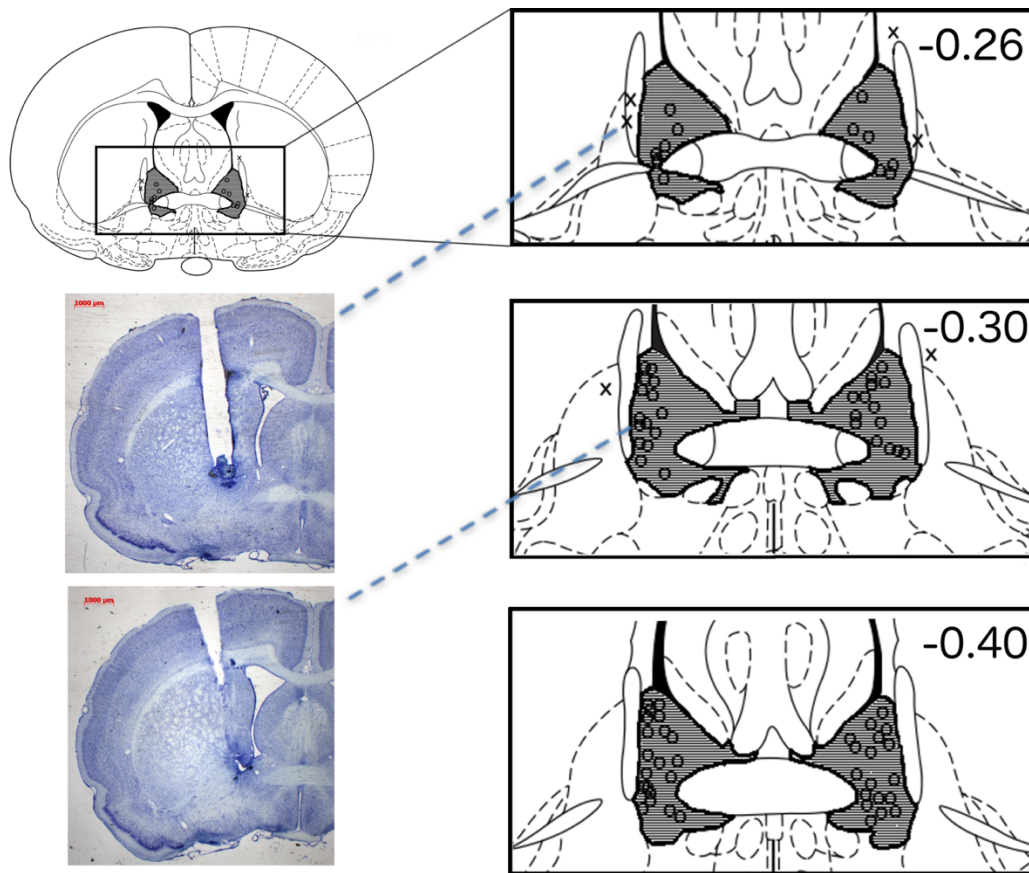

Figure 3.1 Histological confirmation of cannula placements

Histological confirmation of cannula placements within the BNST. Shaded areas indicate regions where successful cannula placements were identified. Locations marked with an “O” indicate the placement of cannula tips within the targeted region. The “X”s indicate placements that missed the target and were separately analyzed as anatomical controls. Not pictured are 6 animals whose cannulae tips were located within the lateral ventricles and 4 animals whose cannulae placements were posterior to the target region. Numbers represent distance of coronal slices (in mm) posterior to bregma. Figure adapted from Paxinos and Watson (2007). The two representative photomicrographs provide an example of a missed cannula placement (top) and a correctly placed cannula (bottom) sitting above the BNST. Dashed lines point to the corresponding cannula placement on the schematic diagram. The darkly-stained areas at the tip of each cannula track reflect the tissue displaced by the cannula insertion.

3.3.2 Experiment I

This experiment tested the effect of intra-BNST infusions of CP 94,253 (0, 0.25, 0.5, or 1.0 μg) on the animals' operant runway behavior performing for single i.v. infusions of cocaine (1.0 mg/kg) reward. Group sizes were $n=12, 8, 12, 12$, respectively for each of the doses employed. Figure 3.2 depicts the runway performance of the animals during the 16 days of testing. The top panel shows the mean (\pm SEM) start latencies of all groups across the 16 runway trials. A two-factor (Group x Trial) ANOVA computed on these data revealed a significant main effect of Trial ($F(15,25) = 3.976, p = .001$), but no significant effect of Group ($F(3,39) = .177, p = .912$) and no significant Group x Trial interaction ($F(45,81) = .792, p = .802$), indicating that all groups reliably and comparably decreased their start latencies over the course of the experiment. CP 94,253 did not, therefore, reliably affect the subjects' response initiation in the runway.

The run time data for each group are shown in the middle panel of Figure 3.2. The two-factor ANOVA computed on these data identified a statistically significant difference in runway performance between the three treatment groups (a main effect of Group; $F(3,40) = 4.043, p = 0.013$). As the figure illustrates, the vehicle animals took the longest to enter the goal box, the low and intermediate doses of CP 94,253 produced the shortest run times, while the high dose group produced intermediate results. Post Hoc analyses confirmed that animals treated with the 0.25 μg and 0.5 μg dose of the 5-HT_{1B} agonist entered the goal box sooner

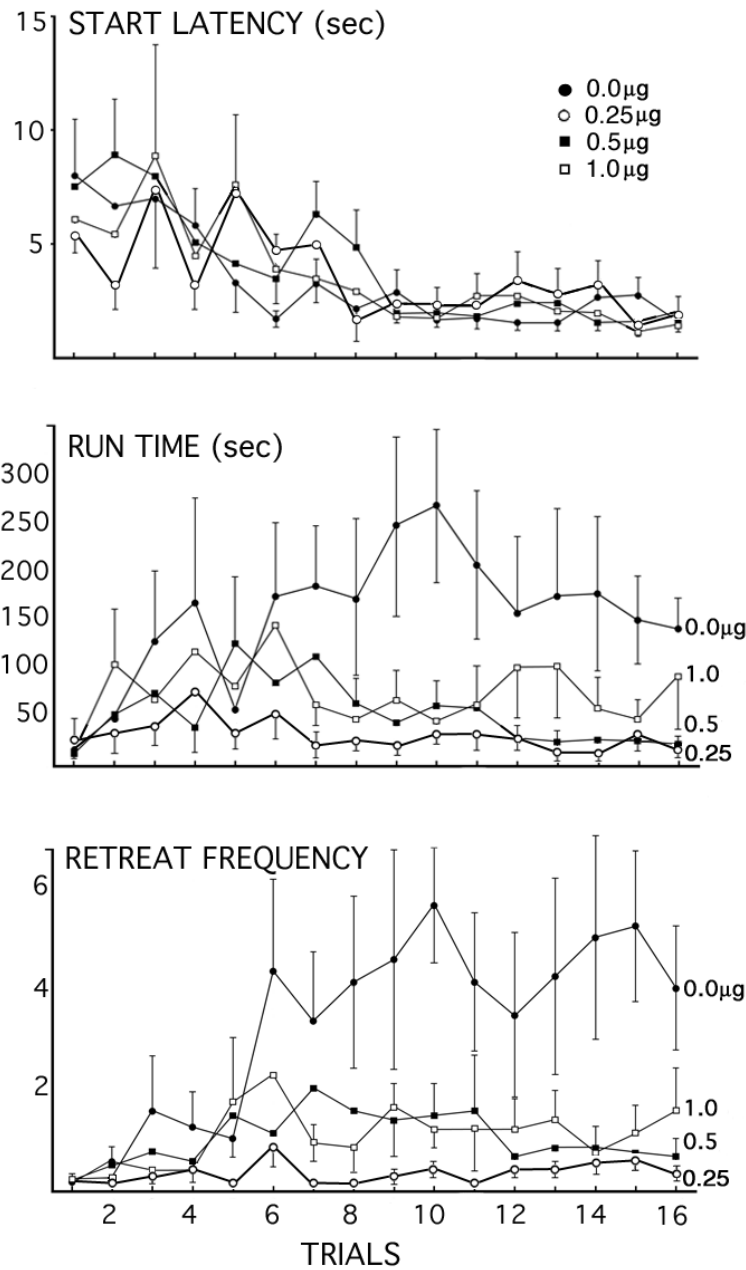

Figure 3.2. Group Mean (\pm SEM) start latencies (top panel), run times (middle panel) and approach-avoidance retreat behaviors (bottom panel) of animals running a straight alley once each day for single daily infusions of 1.0 mg/kg i.v. cocaine after pretreatment with bilateral intra-BNST infusions (0.0, 0.25, 0.5 or 1.0 μ g) of the 5HT_{1B} agonist, CP 94,253. Group sizes were n=12, 8, 12, 12, respectively.

than subjects in the vehicle group (Fischer's Least Significant Difference [LSD] Test; $p = .015$ and $p = .047$, respectively), while the comparison between the high dose and vehicle did not reach statistical significance ($p = .198$). There was no reliable difference observed between the doses of the agonist ($p > .05$). The ANOVA revealed no main effect of Trial; $F(15,26) = 1.137$, $p = .374$, and no significant Group x Trial interaction; $F(45,84) = .908$, $p = .634$.

Analysis of the mean (\pm SEM) retreat frequencies of the four groups (bottom panel of Figure 3.2) revealed a significant main effect of Group ($F(3,40) = 5.332$, $p = .003$) and a significant main effect of Trial ($F(15,26) = 2.093$, $p = .048$). However, the Group x Trial interaction did not reach statistical significance ($F(45,84) = 1.010$, $p = .474$). Post-hoc analyses of the retreat data using Fischer's LSD Tests revealed that animals receiving the $0.25\mu\text{g}$ ($p = .005$), $0.5\mu\text{g}$ ($p = .023$), or $1.0\mu\text{g}$ dose ($p = .034$) of CP 94,253 emitted fewer retreats than those in the vehicle control group, while the difference between the drug groups was not significant ($p > .05$).

3.3.3 Experiment II

As described above, the second experiment was conducted to determine whether intra-BNST administration of CP 94,253 5-min *after* the goal-box administration of cocaine, could prevent or attenuate the impact of cocaine's anxiogenic effects which have been shown to develop 15 min post injection (Ettenberg et al 1999; Knackstedt et al 2002; Jhou et al 2013). Each group was comprised of $n=8$ animals. Post-cocaine treatment with the 5-HT_{1B} agonist

immediately after removal from the goal box effectively reduced the frequency of approach-avoidance retreats (see Figure 3.3). There was a significant main effect of Group ($F(1,14) = 7.963, p = .014$), Trial ($F(15,210) = 6.155, p < .001$), and a significant Group x Trial interaction ($F(15,210) = 2.586, p = .001$). As the figure illustrates, while both groups behaved comparably at the outset of testing, the treatment group continued to exhibit relatively low levels of retreat behavior while the vehicle-treated animals produced increased retreats as testing progressed.

The results for Start Latency and Run Time (data not shown) were comparable to those reported for Experiment I. Start latencies decreased as testing progressed (a significant main effect of Trial; $F(15,210) = 2.865, p < .001$), and did so comparably for both groups (there was no main effect of Group and no Group x Trial interaction ($p > .05$)). Although Run Times tended to increase on average across both groups as retreat frequencies increased (a significant main effect of Trial; $F(15,210) = 4.458, p < .001$), the CP 94,253 group entered the goal box sooner than the vehicle-treated animals (a significant main effect of Group; $F(1,14) = 5.246, p = .038$). The Group x Trial interaction was not statistically significant ($p > .05$).

3.3.4 Experiment III

This experiment was conducted to assess the efficacy of a highly selective 5-HT_{1B} antagonist in reversing the effects of CP 94,253 observed in Experiment I. Group sizes were $n=8$ for vehicle treated animals, $n=7$ in the CP 94,253 alone group, $n=9$ for the low dose (0.1 μg) NAS-181, $n=8$ for the high dose (1.0 μg). The selective

antagonist NAS-181 was able to block the reduction in retreats when co-administered with the 0.5 μg intermediate dose of CP 94,253 (see Fig. 3.4). Total retreat frequency was collapsed into Trials 1-8 and Trials 9-16, and a series of one-tailed repeated measures *t*-tests were conducted on these retreat frequency data. These *t*-tests revealed a significant increase in retreats over time in the vehicle treated group $t(8)=-2.442, p = 0.020$; as well as with both the low and high doses of NAS-181, $t(8)=-2.140, p = 0.033$, and $t(7)=-2.447, p = 0.022$, respectively.

In the group treated with CP 94,253 alone, there was no significant increase in retreat behavior, $t(6)=-0.603, p = .284$, which partially replicates the findings of Experiment I. Finally, the results from the 16 animals whose data were removed after histological analyses were used here as an “anatomical control” – these animals all received CP 94,253 but their cannula were deemed to be outside the BNST target. These subjects performed comparably to cocaine+ vehicle controls and exhibited an increase in retreat frequency over trials [$t(15)=-2.569, p = .01$] thereby demonstrating the critical importance of selective action of the 5-HT_{1B} agonist within the BNST.

3.3.5 Locomotor Activity Test

The effects of CP 94,253 on spontaneous locomotor behavior are shown in Figure 3.5. Two factor ANOVAs (Group x Time) were computed on the data depicted in the figure and on the initial 60 min baseline/acclimation period (data not shown). As expected, there was no difference in the performance of the three groups during

baseline (main effect of Group; $p > .05$) and no Group x Time interaction. There was a significant main effect for Time ($F_{(11,19)}=61.041, p < .001$) indicating that all animals showed normal and comparable habituation to the novel locomotor-chamber environment prior to the administration of CP 94,253.

The data from the 5-HT_{1B} agonist challenge, using the same dose each animal received during runway testing, similarly confirmed a main effect of Time ($F_{(2,38)}=123.119, p < .001$) as all animals slowed their activity over time. Although there appears to be a slight suppression of locomotor activity with the lowest dose, this effect did not reach statistical significance ($p = .176$) nor was there a significant Group x Time interaction ($p > .05$). Thus, treatment with the 5-HT_{1B} agonist did not produce any reliable changes in locomotion compared to the vehicle-treated control group. Nevertheless, even the mild suppression of locomotor activity at the 0.25 μ g dose cannot account for the differences seen in runway behavior, as this group reliably showed the fastest run times and fewest retreats. Locomotor testing of the 5-HT_{1B} agonist/antagonist combination similarly showed no non-specific motoric effects of the microinjection (data not shown).

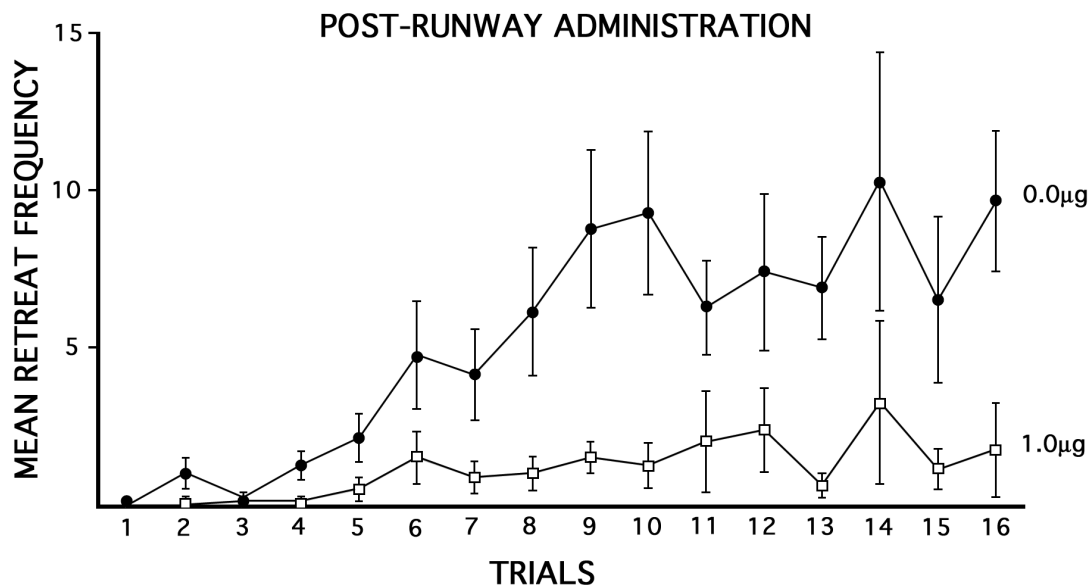

Figure 3.3 Post-Runway administration of CP 94,253
 Mean (\pm SEM) retreat frequency of animals treated with bilateral intra-BNST infusions of 0.0 or 1.0 μ g/side of the 5HT_{1B} agonist, CP 94,253, 5-min *after* single daily trials in animals running a straight alley for 1.0 mg/kg i.v. cocaine. n=8 per each treatment group.

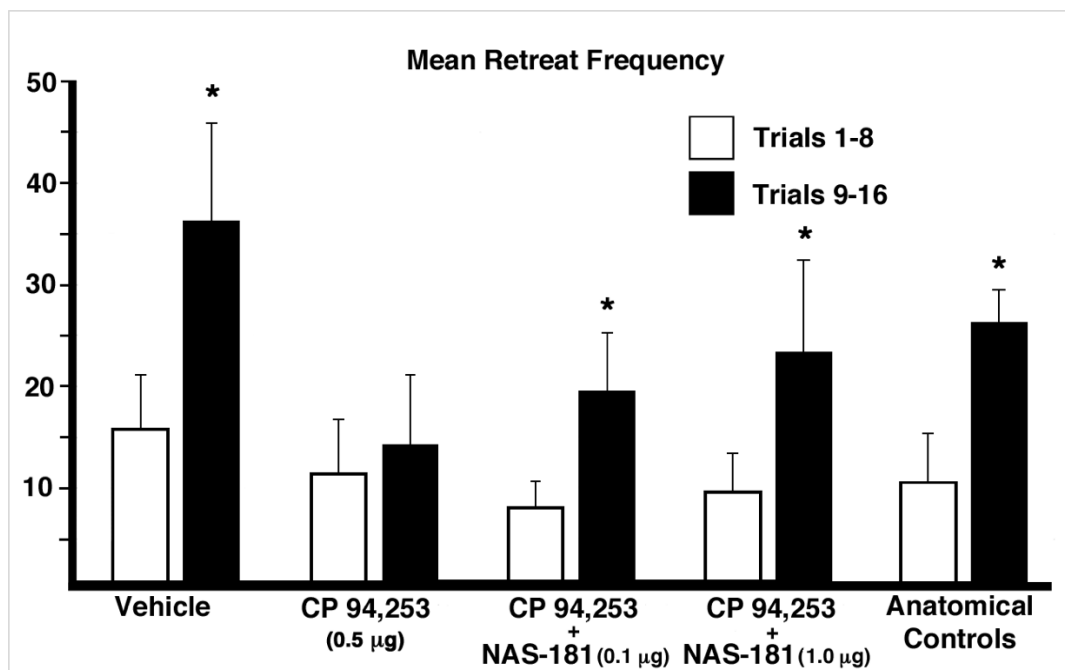

Figure 3.4 Mean (\pm SEM) retreat frequency of animals running an alley for single daily iv infusions of 1.0 mg/kg cocaine delivered upon goal-box entry. The group designations refer to the bilateral intra-BNST infusions that each group received prior to each trial. Retreats were summed across the first half (trials 1-8) and second half (trials 9-16) of the experiment. Group sizes were $n=8$ for vehicle treated animals, $n=7$ in the 5-HT_{1B} autoreceptor agonist CP 94,253 (0.5 μ g) group, $n=9$ for the CP 94,253 + the low dose (0.1 μ g) of the autoreceptor antagonist NAS-181, $n=8$ for CP 94,253 + high dose of the antagonist (1.0 μ g), and $n=16$ for the anatomical control group (which received 0.5 μ g of CP 94,253 alone but whose cannulae were histologically determined to have missed the BNST target site). The data analyses compared the performance of each group during the first 8 trials to that on the final 8 trials $*p < .05$.

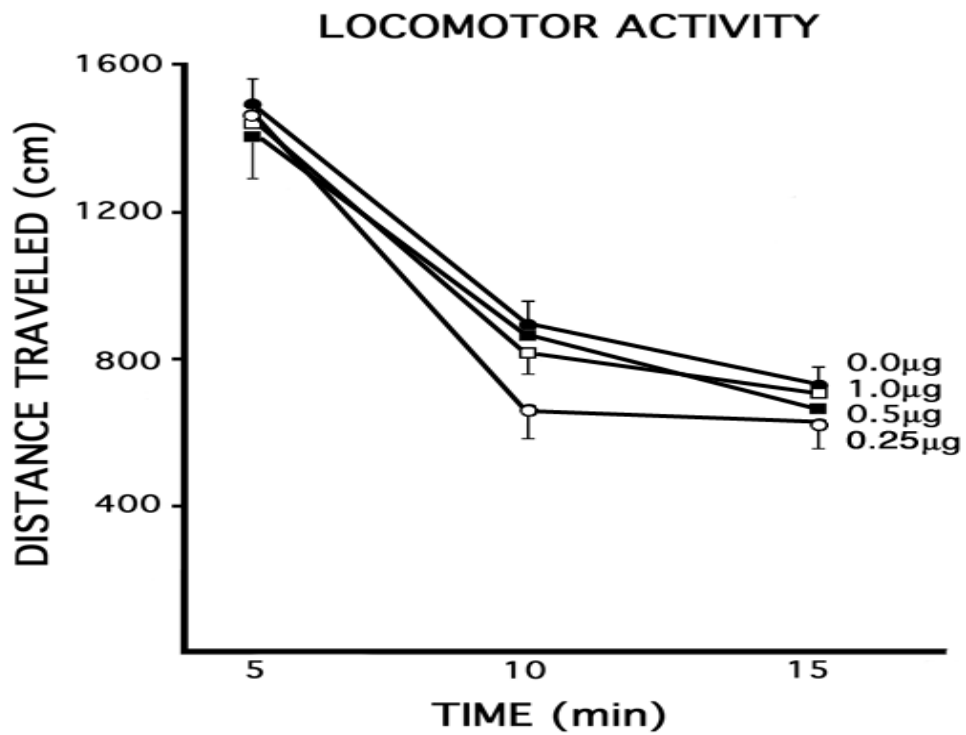

Figure 3.5 Spontaneous Locomotor Activity

The spontaneous locomotor response (measured as distance traveled in cm) of animals each pretreated with different doses of the 5HT_{1B} agonist, CP94,253 (0.0, 0.25, 0.5 or 1.0 μg/side). Each time point represents 5 mins of locomotor activity. Drug treatments produced no reliable alterations in locomotor activity

3.4 Conclusions

A thorough discussion of the significance of these findings, and of the putative role of serotonin for the anxiogenic effects of self-administered cocaine, are provided in the final Chapter of this document. What follows below is a summary of the behavioral effects observed in cocaine-seeking animals treated with intra-BNST CP 94,243 and the conclusions stemming from those results.

- Start latencies decreased over the course of trials for all groups of animals, irrespective of treatment, indicating that activation of 5-HT_{1B} auto-receptors in the BNST did not affect the animals' motivation to seek 1.0 mg/kg i.v. cocaine. This result is consistent with previous reports from our laboratory that antagonism of 5-HT cell function within the DRN similarly did not alter the start latencies of rats running an alley for cocaine (Ettenberg et al., 2011) and that systemic administration of a 5-HT antagonist did not alter the conditioned place preferences produced by pairing a novel environment with the immediate effects of i.v. cocaine (Ettenberg & Bernardi, 2007).
- Also as previously reported (see review by Ettenberg, 2004), Run Times increased over the course of testing in cocaine-reinforced animals treated with i.c. vehicle. This effect was significantly reversed by intra-BNST application of CP 94,243, suggesting that activation of 5-HT_{1B} receptors in the BNST rendered the

animals less ambivalent about entering the cocaine-associated goal box compared to vehicle-treated animals.

- The hypothesis that the changes in Run Time reflect reductions in ambivalence about goal-box entry is supported by the observation that CP 94,253 infused into the BNST also produced significant reductions in the frequency of approach-avoidance retreat behaviors.
- These effects of intra-BNST CP 94,253 cannot be easily accounted for by a general reduction in anxiety produced by the pretreatment prior to runway testing, since post-treatment (5 mins *after* cocaine infusion) with CP 94,253 was also effective at reducing retreat behaviors even when the animals were tested in an undrugged state.
- Additionally, the reductions in retreat frequency and faster Run Times produced by intra-BNST CP 94,253 cannot be accounted for by a nonspecific change in the subjects' level of arousal or activity since the treatments did not produce significant alterations in locomotor activity.
- The specificity of the observed effects to the 5-HT_{1B} receptor, was confirmed by the observation that the behavioral actions of the agonist were reversed by co-administration with the selective 5-HT_{1B} antagonist NAS-181.
- Given the known high density of 5-HT_{1B} receptors on serotonergic terminals within the BNST(Hazra et al., 2012) it is hypothesized that the current results are attributable to a reduction in 5-HT release within the BNST.

- On that basis, one can conclude that the changes in runway behavior observed in treated animals are consistent with the hypothesis that 5-HT innervation of the BNST contributes to the anxiogenic response to cocaine.
- Chapter 4, which follows below, describes experiments comparable to those described here but focused instead on the LHb by examining the impact of intrahabenular CP 94,243 on the behavior of animals seeking cocaine in the runway.

Chapter 4: Cocaine, Serotonin, and the Lateral Habenula (LHb)

4.1 Introduction

The set of experiments described in this chapter reflect the same approach as that described in the previous chapter for the study of how 5-HT release in the BNST affects the anxiogenic response to cocaine – with the exception that the brain target now is the lateral habenula (Hb). As discussed in Chapter 1, the Lateral Habenula (LHb) has been implicated in the modulation of both rewarding and aversive states (Lecca, Meye, & Mameli, 2014; Meye, Lecca, Valentinova, & Mameli, 2013; Velasquez et al., 2014). Electrophysiological studies of the LHb suggest a role for this region in preventing or blocking the behavioral impact of rewarding stimuli via an inhibition of midbrain substantia nigra dopamine (DA) “reward” neurons (Matsumoto & Hikosaka, 2007, 2009). Indeed, studies of both human (Shepard et al., 2006; Ullsperger & Cramon, 2003) and animal subjects (e.g., Ootsuka & Mohammed, 2015; Tomaiuolo et al., 2014), indicate that the LHb is activated by the presentation of aversive stimuli, including the administration of cocaine (Gill et al., 2013; Jhou et al., 2013). The putative importance of 5-HT in the functional role of the LHb is suggested by the fact that it has prominent reciprocal projections to both the dorsal (DRN) and median (MRN) raphe nuclei of the brainstem (Lidov & Molliver, 1982; Luo et al., 2015; Metzger et al., 2017) and that it expresses a whole host of 5-HT receptors, including the 5-HT₁, 5-HT₂, 5-HT₃, 5-HT₅, and 5-HT₇ families (Metzger et al., 2017). Of particular interest to the current study is the presence of inhibitory 5-HT_{1B} receptors in the LHb (Tchenio et al., 2016; Wagner, Bernard, et al., 2016;

Wagner, French, et al., 2016). As described in Chapter 1, the 5-HT_{1B} receptor is an inhibitory Gi-coupled receptor that is primarily located on axon terminals as an auto- or hetero-receptor (Boschert et al., 1994). Additionally, systemic treatment with 5-HT_{1B} agonists has been shown to produce anxiolytic-like effects across multiple behavioral tests (Chojnacka-Wojcik et al., 2005; Tatarczynska, 2004), which further supports the hypothesis that this receptor may be involved in modulating the anxiogenic response to cocaine. Thus, the present study was designed to investigate the role of 5-HT signaling in the LHb (via manipulation of 5-HT_{1B} receptors) on the development of the anxiogenic effects of cocaine as measured in the drug self-administration runway.

4.2 Materials and Methods

4.2.1 Subjects

Subjects were 122 Male Sprague-Dawley rats, with housing and living conditions as described in Chapter 2 above.

4.2.2 Surgery

Surgical procedures were performed as described in Chapter 2. Briefly, rats were fitted with an i.v. jugular catheter and implanted with bilateral cannula aimed 2.0 mm above the LHb.

4.2.3 Drugs

Cocaine hydrochloride and the 5-HT_{1B} agonist CP 94,253 dihydrochloride were prepared as previously described. Once again, to demonstrate specificity to the

5-HT_{1B} receptor, the antagonist NAS-181 was employed to reverse any observed behavioral effects obtained with the 5-HT_{1B} agonist.

4.2.4 Procedures

After a single 10 min habituation trial, the first of 16 consecutive one-trial-per-day runway trials was initiated (see Fig 2.2 for the experimental timeline). Prior to each trial, the subjects were administered bilateral intra-LHb infusions (0.5 µl/side) of one of two doses of CP 94,253 (0.1 or 0.25 µg/side (in Experiment IV), or the combination of 0.25µg CP 94,253 with 0.1 µg NAS-181 per side (Experiment V), or vehicle prior to each runway trial. After 10 min, each subject was moved to the runway apparatus, connected to the i.v. drug delivery system, and tested for their motivation to seek cocaine. Once again, all trials for a given subject were conducted in the same apparatus and catheter patency was maintained by flushing the catheters daily with 0.1 ml of cefazolin/gentamycin followed by 0.1 ml heparinized saline after removal from the apparatus.

4.3 Results

4.3.1 Histology

Figure 4.1 shows the placement of bilateral cannula tips located in the targeted region (figure adapted from the brain atlas of Paxinos & Watson, 2005). Inclusion of subjects in the experiment required strict histological confirmation that both cannula tips were accurately localized to the LHb. Any animal with microinjector tips located outside the target region or displaying significant necrosis

around injector tips was removed from the study (n=23). The final histological determination of a subject's inclusion in the study was made by a trained individual blind to that animal's treatment group. An additional 30 animals failed to maintain catheter patency throughout the duration of the study and were similarly removed from the data analysis resulting in a final total sample size of 69 subjects for data analysis.

4.3.2 Experiment IV: Intra-LHb Infusion of CP 94,253

This experiment tested the effects of bilateral intra-LHb microinjections of CP 94,253 (0, 0.1, or 0.25 $\mu\text{g}/0.5 \mu\text{l}/\text{side}$) on the runway behavior of animals approaching and entering a goal box associated with the administration of 1.0 mg/kg i.v. cocaine. Group sizes were $n = 22, 13, 18$, respectively. Figure 4.2 depicts the mean ($\pm\text{SEM}$) runway performance of the 3 groups of animals during the 16 days of runway testing. A two-factor (Group x Trials) Analysis of Variance (ANOVA) conducted on the start latency data revealed a significant main effect of Trial $F(15,750)=6.822, p < .001$, but no main effect of Group and no Group x Trial interaction ($p's > .05$). Thus, all animals, irrespective of group, learned the association between the goal box and drug delivery and displayed an increasing motivation to seek the drug (faster start times) as testing progressed.

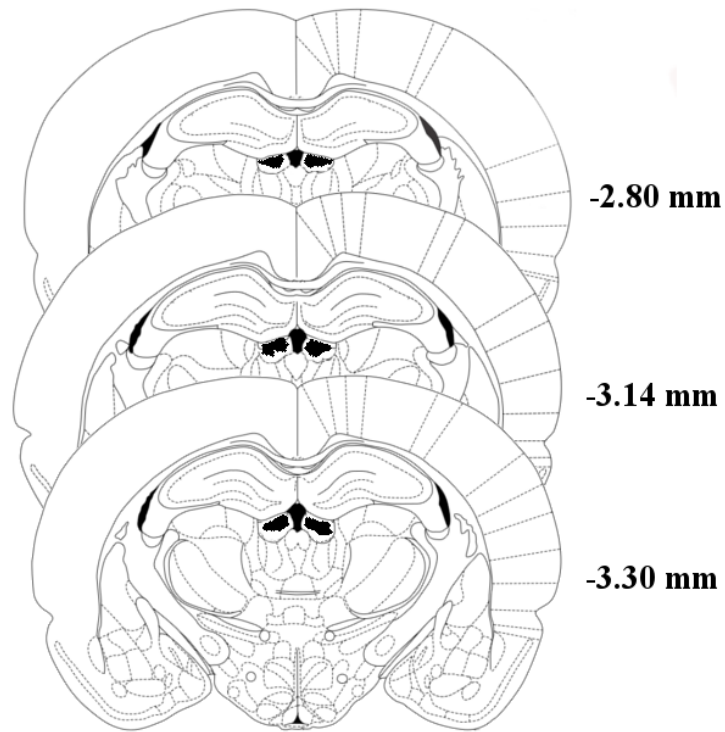

Figure 4.1 Histological confirmation of cannula placements in the LHb. Shaded areas indicate regions where successful cannula tip placements could be verified. Numbers represent distance of coronal slices posterior to bregma. Due to the volume of drug injected (0.5 μ l/side) and the target region's proximity to the midline, the area affected likely includes a broad region of both the lateral habenula (LHb) and medial habenula (MHb). Figure adapted from Paxinos & Watson (2007).

Despite the fast start latencies, animals took longer and longer to enter the goal box over trials. Another two-factor (Group x Trial) ANOVA computed on the run time data confirmed a significant main effect of Trial ($F(15,750)=2.876, p < .001$) but in the opposite direction of start times (i.e., longer latencies; see middle panel of Figure 4.2). While there was no main effect of Group ($F(2,50)=2.298, p = .111$), there was a statistically significant Group x Trial interaction ($F(30,750)=1.641, p = .017$), reflecting the fact that on the early trials of testing the Groups performed comparably while by the end of testing the run times of the three groups diverged. A series of pairwise comparisons computed on these data revealed a significant group difference between animals treated with vehicle versus the $0.25\mu\text{g}$ dose ($p = .038$). To confirm this assessment, the mean Run Times for the three groups were recomputed by averaging performance during the first 8 trials to that observed during the final 8 trials (as described and illustrated in Chapter 3). Those results are depicted in Figure 4.3A. A two-factor (Group x Trials) ANOVA computed on these data produced results consistent with the ANOVA computed on all trials. There was no main effect of Trials ($F(1,50)=0.185, p = .669$), or Group ($F(2,50)=2.298, p = .111$), however there was a significant Group X Trials interaction ($F(2,50)=3.982, p = .025$). To elucidate the source of this interaction, a one-way ANOVA was computed on the data for each set of trials, which revealed no group differences during trials 1-8 ($F(2,52)=0.373, p = .691$), but a significant effect of Group during trials 9-16

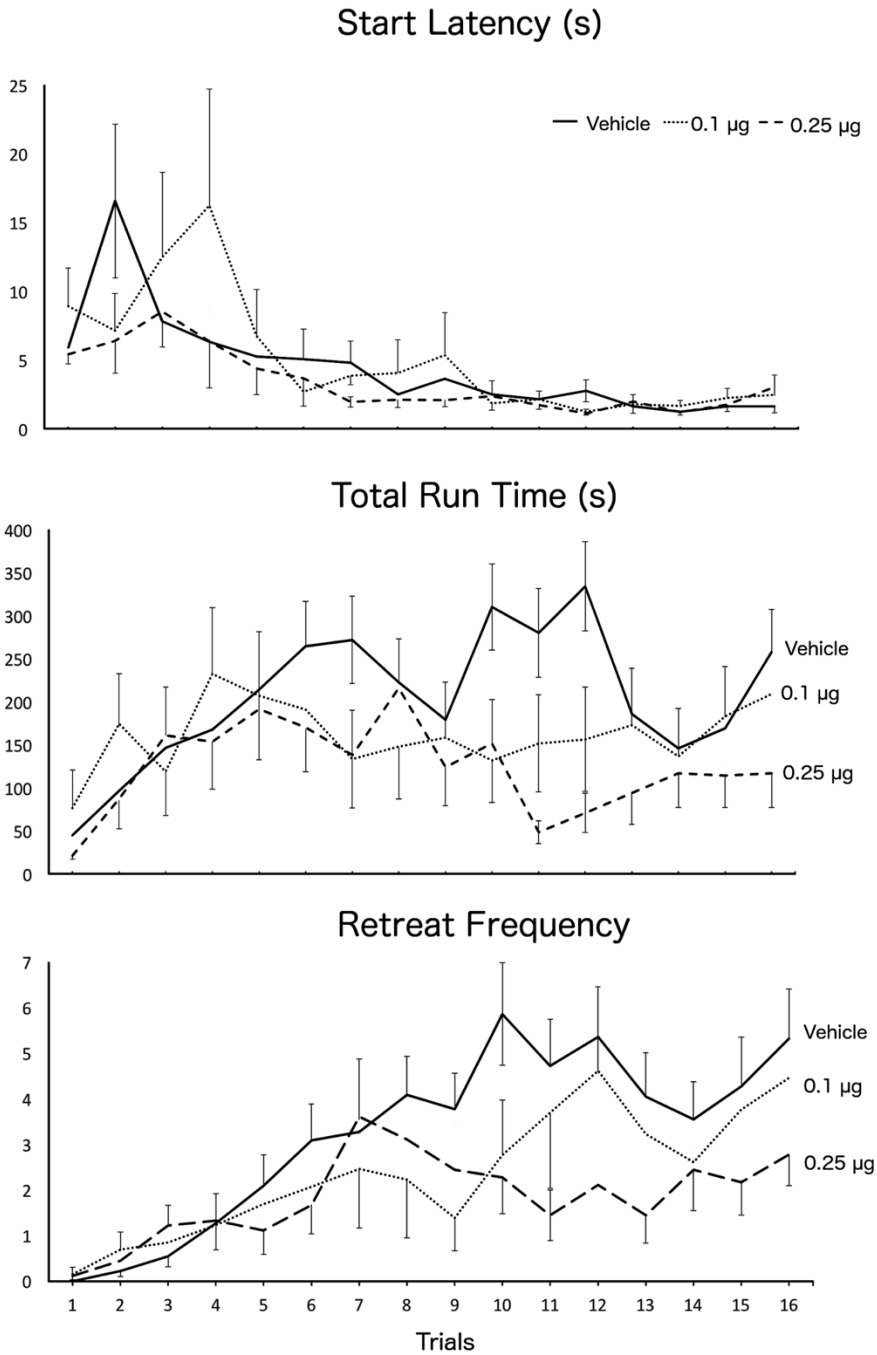
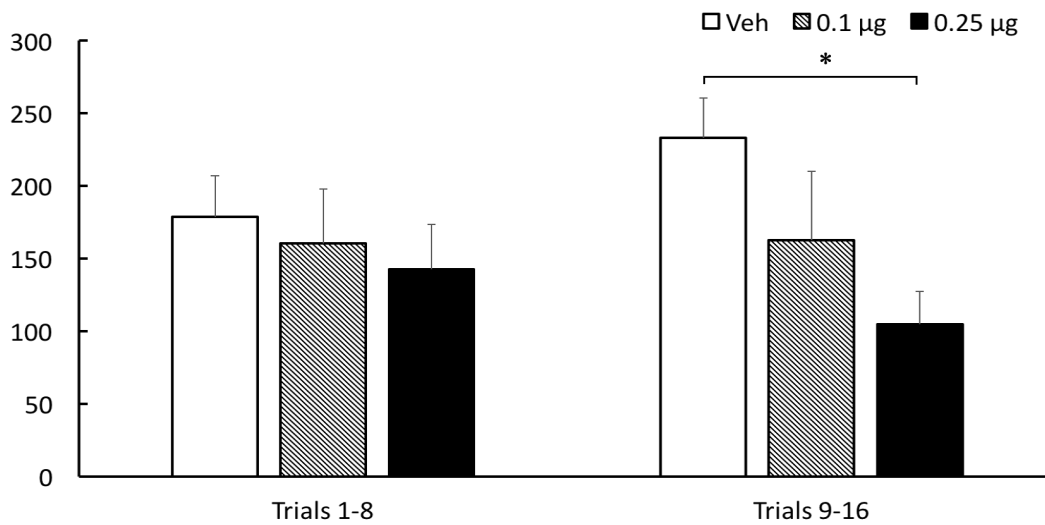

Figure 4.2
 Group Mean (\pm SEM) start latencies (top panel), run times (middle panel), and approach-avoidance retreat behavior (bottom panel) of animals running a straight alley once daily for an infusion of 1.0 mg/kg i.v. cocaine after pretreatment with either 0.1 (dotted lines) or 0.25 μ g (dashed lines) CP 94,253, or vehicle (solid lines) into the LHb.

A: Mean Run Times



B: Mean Retreat Frequency

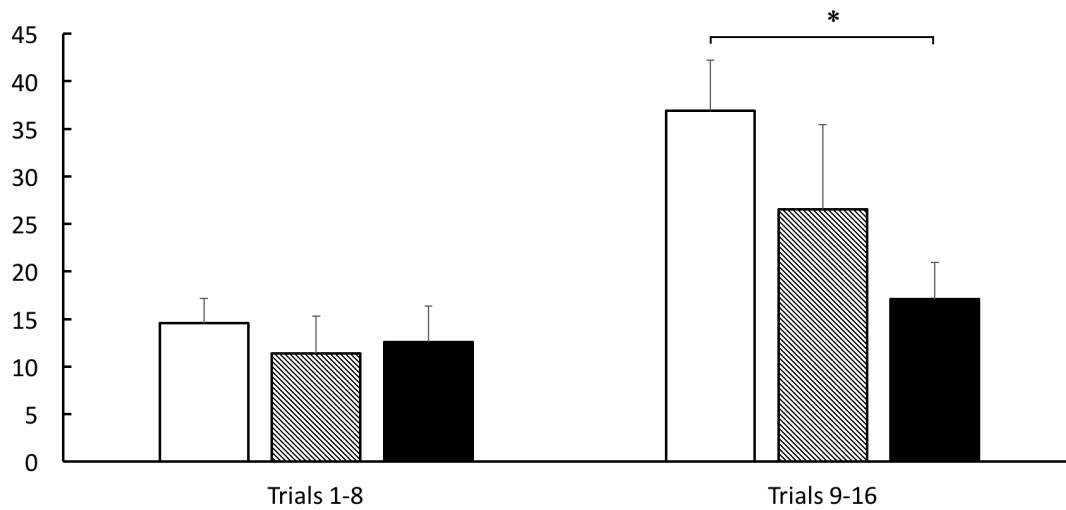

Figure 4.3 Top Panel (A): Group Mean (\pm SEM) Total Run Times averaged over the first half (left) of trials and the last half (right) for animals treated with bilateral infusions of vehicle (Veh), 0.1 μ g or 0.25 μ g of CP 94,253 into the LHb. Bottom Panel (B): Group Mean (\pm SEM) retreat frequency summed over the first half and the last half of runway trials. * ($p < .05$) when compared to vehicle

($F(2,52)=4.778, p = .013$). Post hoc analysis by LSD testing showed that the 0.25 μg dose was significantly different than vehicle-treated animals ($p = .003$).

The increase in Run Times observed as testing progressed was mirrored by the frequency of approach-avoidance retreat behaviors (see Figures 4.2 and 4.3B). Not surprisingly, an animal that stops and retreats back toward the start box will necessarily delay its entry into the goal box. This was confirmed via Pearson correlational analyses, whereby each animal's run time was correlated with the frequency of approach-avoidance retreats during each of the 16 days of testing. Unsurprisingly, the correlation between run times and retreats was statistically significant on all 16 days of testing (Table 4.1).

A two-factor (Group x Trials) ANOVA was computed on the approach-avoidance retreat data (Figure 4.2, bottom panel), which revealed a significant main effect of Trials ($F(15,750)=8.865, p < .001$), but no effect of Group ($F(2,50)=1.909, p = .159$), and only a marginal Group x Trials interaction ($F(30,750)=1.404, p = .075$). However, as was done for the run time analysis, the data were analyzed by comparing performance over the first half of trials versus the last half of trials. The results were comparable to those observed for run times. A two-factor (Group X Trials) ANOVA was computed on the data collapsed across trials. This analysis revealed a significant main effect of Trials ($F(1,50)=30.742, p < .001$), no main effect of Group ($F(2,50)=1.909, p = .159$), and a significant Group x Trials interaction ($F(2,50)=4.891, p = .011$).

Table 4.1. Correlations between Total Run Time and Retreat Frequency across trials

<u>Trial</u>	<u>Pearson R=</u>	<u>P - Value</u>
1	.442	.001
2	.392	.004
3	.614	<.001
4	.716	<.001
5	.608	<.001
6	.728	<.001
7	.620	<.001
8	.558	<.001
9	.638	<.001
10	.725	<.001
11	.732	<.001
12	.770	<.001
13	.775	<.001
14	.788	<.001
15	.694	<.001
16	.750	<.001

As was the case for Run Times, a one-way ANOVA comparing group behavior over the first half of trials produced no reliable differences ($F(2,52)=.233, p = .793$), while a significant group effect was identified during the second half of runway trials ($F(2,52)=3.260, p = .047$). Post hoc analysis via LSD testing showed a significant difference between the 0.25 μg dose group and vehicle ($p = .014$). Indeed, as Fig 4.3B illustrates, while retreats increased during the second half of the experiment in the vehicle group (as we have seen previously; e.g. see review by Ettenberg, 2004), intra-LHb pretreatment with the 5-HT_{1B} agonist CP 94,253 dose-dependently reversed this effect.

4.3.3 Experiment V: Co-administration of 5-HT_{1B} agonist and antagonist

To demonstrate specificity to the 5-HT_{1B} receptor subtype, the effective dose of 0.25 μg CP 94,253 was challenged by co-administration of the selective 5-HT_{1B} receptor antagonist, NAS-181 (0.1 $\mu\text{g}/\text{side}$; $n=16$). NAS-181 was effective at reversing the effect of the agonist on approach-avoidance retreat behavior when co-administered with 0.25 μg of CP- 94,253 (Figure 4.4). As in the previous experiment, data for this group was collapsed into the first half and second half of runway trials, and then analyzed by a paired sample two-tailed t-test, which revealed a significant difference in retreat behavior over the course of trials ($t(15)=-2.503, p = .024$). Indeed, these animals behaved much like the vehicle-treated subjects in Experiment IV (Fig 4.3B) and increased the number of retreats as testing progressed. A direct comparison between the retreat behavior of Vehicle-treated animals from

Experiment IV on Trials 9-16 and the animals in Experiment V from the same time period showed no differences between the groups ($t(36)=1.207, p = .235$). The antagonist, therefore, reversed the retreat-suppressing effects of the 5-HT_{1B} agonist alone.

4.3.4 Locomotor Activity Test

The effects of CP 94,253 on spontaneous locomotor activity was assessed by a two-factor (Group x Time) ANOVA computed on data acquired for 15 mins following drug infusion (depicted in Figure 4.5). Although there was an expected reduction in locomotor activity over time as animals habituated to the apparatus (significant main effect of Time: $F(2,86)=165.85, p < .001$), there was no main effect of Group ($F(2,43)=1.315, p = .279$) and no Group x Time interaction ($F(4,86)=.442, p = .778$). Thus, manipulation of the 5-HT_{1B} receptor in the LHb produced no perceptible alterations in the spontaneous ambulatory behavior of subjects relative to vehicle control. Additionally, in a subsequent locomotor test of animals from Experiment V, treatment with CP 94,253 + NAS-181 produced no reliable changes (compared to the agonist alone) in locomotor behavior (data not shown).

Retreat Frequency NAS-181 + CP 94,253

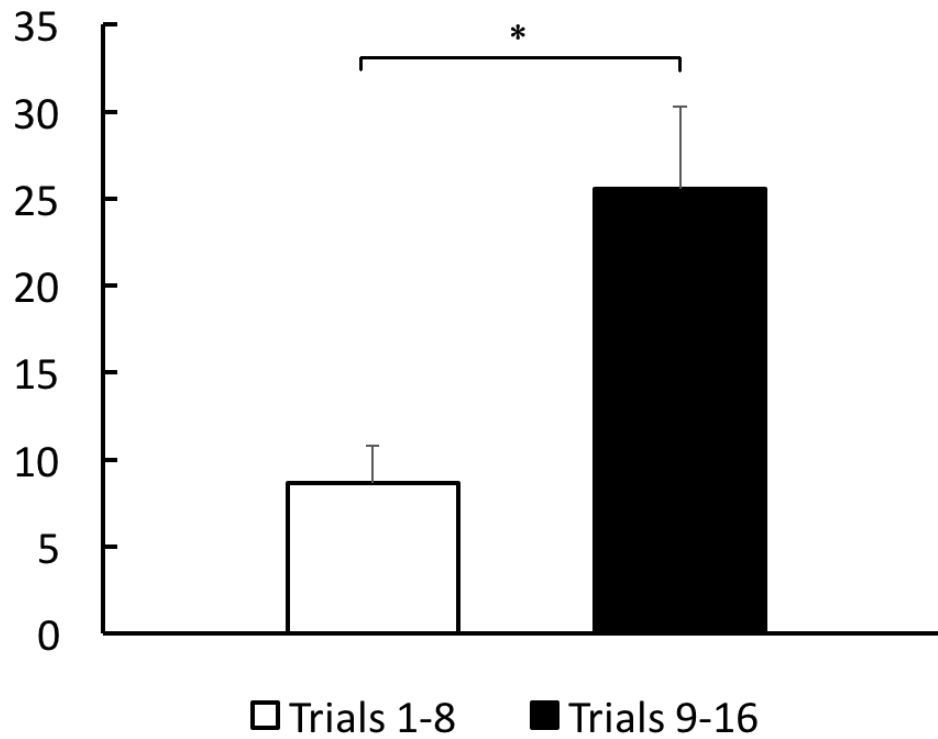

Figure 4.4 CP 94,253 + NAS-181 in the LHb

Group Mean (\pm SEM) retreat frequency was summed over the first half (left) of trials and the last half (right) for the $n=16$ animals who received the combined infusion of $0.25 \mu\text{g}$ CP 94,253 and $0.1 \mu\text{g}$ NAS-181 prior to runway testing. * $p < .05$

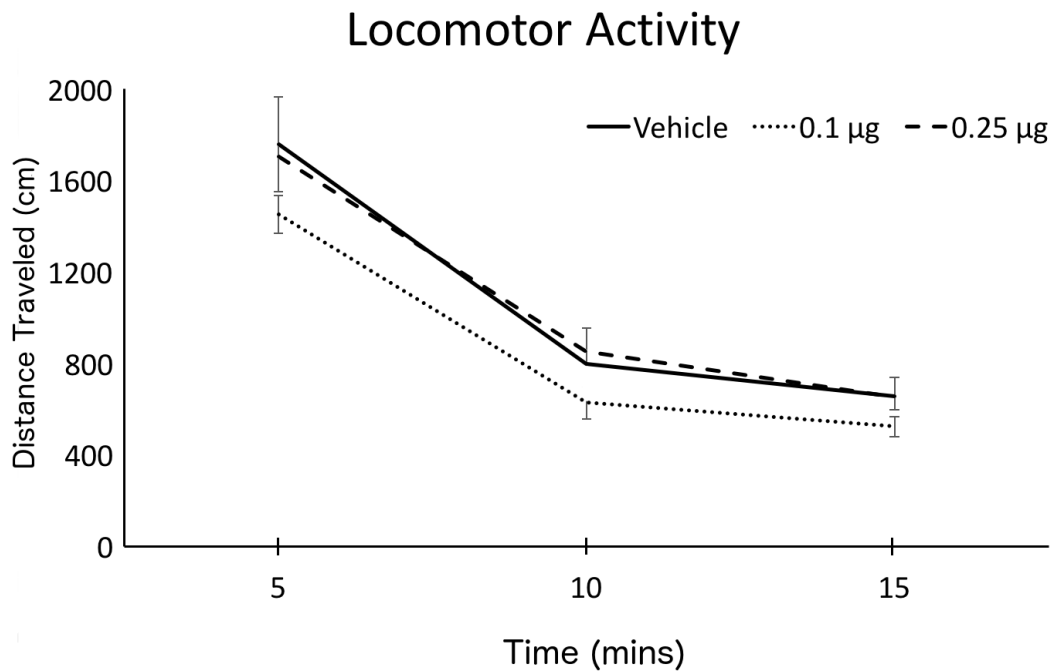

Figure 4.5 Spontaneous locomotor activity
Group Mean (\pm SEM) spontaneous locomotor activity immediately after infusion of CP 94,253. The total distance traveled (cm) was recorded over 5-min intervals for a 15-min test session.

4.4 Conclusions

- As described in Chapter 3, start latencies were found to decrease as runway testing progressed for all groups of animals indicating that, as was the case for intra-BNST manipulations, activation of 5-HT_{1B} receptors within the LHb did not affect animals' motivation to seek 1.0 mg/kg i.v. cocaine. The positive incentive properties of cocaine appear to have been unaffected by intra-LHb administration of CP 94,253.
- While vehicle-treated animals working for cocaine exhibited the typical increase in run times over trials, intra-LHb CP 94,253 produced a dose-dependent reduction in this effect.
- CP 94,253 was also observed to produce dose-dependent reductions in the frequency of approach-avoidance retreat behaviors as animals ran the alleyway for cocaine.
- The changes observed in run times (time to enter the goal box) would, of course, be expected to increase as animals exhibit changes in the frequency of approach-avoidance retreat behaviors – i.e., it should take longer to enter the goal box if the subject is making increasing numbers of approach-avoidance responses. This was confirmed by the demonstration of strong and highly significant correlations between the run times and retreat frequencies across all animals in all groups.

- As was the case for intra-BNST applications of CP 94,253, intra-LHb infusion of the 5-HT_{1B} agonist did not produce significant alterations in spontaneous locomotor activity which could otherwise have accounted for the observed differences in runway behavior.
- Finally, the specificity of CP 94,253's agonist effects at the 5-HT_{1B} receptor was confirmed by the observation that the agonist's behavioral effects were reversed by co-administration of the selective 5-HT_{1B} antagonist NAS-181.
- It would seem then that serotonergic innervation of both the lateral habenula (this Chapter) and the BNST (Chapter 3) can contribute to or modulate the anxiogenic/aversive response to self-administered cocaine.
- This hypothesis was further tested in the experiments described in Chapter 5, which examined the impact of selective lesions of the 5-HT terminals within the BNST and LHb.

**Chapter 5: Effects of selective lesions of 5-HT terminals within the BNST & LHb on
the runway behavior of rats working for cocaine**

5.1 Introduction

The previous chapters described experiments that all used the same method of pharmacological inhibition of serotonergic synapses via activation of 5-HT_{1B} autoreceptors. While this method is useful, it does have some disadvantages, including: the necessity of repeated intracranial infusions, the handling stress associated with the aforementioned infusions, potential for infection or tissue necrosis from repeated cerebral trauma, as well as the potential for off-target effects mediated by 5-HT_{1B} receptors on other, non-serotonergic synapses in the regions of interest. To address those issues, the use of a selective serotonergic neurotoxin was used in the experiments described herein. This neurotoxin is a drug called 5,7-Dihydroxytryptamine, which works by entering serotonergic terminals via SERT, and through the production of oxidative free radicals causes denervation of the affected region (Baumgarten, Klemm, Sievers, & Schlossberger, 1982; Daly, Fuxe, & Jonsson, 1974). It is potent enough to effectively eliminate the brain of serotonin from selective brain targets (Fuxe & Jonsson, 1974). For this reason, it has become an important tool to study the behavioral effects mediated by brain 5-HT systems. For example, it has been used to assess the role of 5-HT in conditioned reward (Fletcher et al., 1999), the processing of irrelevant stimuli in the NAcc (Nelson et al., 2012), and the anxiogenic response of animals to aversive stimuli or environments (Sziray, Kuki, Nagy, Markó, Kompagne, & Lévy, 2010). It has also been used to disrupt fear conditioning and anxiety through 5-HT depletion in the basolateral

amygdala (Johnson, Molosh, Fitz, Arendt, Deehan, Federici, Bernabe, Engleman, Rodd, Lowry, & Shekhar, 2015). In the present set of experiments, the effects of 5,7-DHT-induced lesions of 5-HT terminals in the BNST and LHb were examined on the runway behavior of animals working for i.v. cocaine.

5.2 Materials and Methods

5.2.1 Subjects

Subjects were 85 Male Sprague-Dawley rats, with housing and living conditions as described in Chapter 2 above.

5.2.2 Surgery

Surgical procedures were performed as outlined in Chapter 2. Rats were each fitted with an intravenous jugular catheter while still under deep anesthesia. During the same surgery, each animal received bilateral microinjections of either 8.0 µg/1.0 µl 5,7-DHT or vehicle (0.2% Ascorbic acid in 0.9% physiological saline). Each infusion was performed slowly, at a rate of 200 µl/min for 5 mins, after which the infusion cannula was left in place for an additional 2 mins to allow the drug to diffuse into the target areas and away from the cannula tip. To prevent damage to NE terminals in the target areas, 30 mins before the 5-HT neurotoxin applications each animal was treated with 25 mg/kg desipramine (Sigma-Aldrich) i.p. (Nelson et al., 2012; Sziray et al., 2010). The coordinates employed for the stereotaxic application of the neurotoxin were aimed directly into the BNST or LHb (not above the targets, as in the previous experiments). The coordinates, relative to bregma were: for the BNST,

AP -0.4, ML \pm 3.5, and DV -6.4 from skull surface with a lateral inclination of 15°, and for the LHb, AP -3.4, ML \pm 1.5, and DV -3.4 from skull surface with a lateral inclination of 11° (Paxinos & Watson, 2007).

5.2.3 Drugs

As described in chapter 2, cocaine hydrochloride served as the drug reinforcer in the runway studies and was again infused i.v. in the goal box at a dose of 1.0 mg/kg/infusion. The selective serotonergic neurotoxin, 5,7-Dihydroxytryptamine (5,7-DHT) was prepared in a vehicle of 0.2% ascorbic acid and a concentration of 8.0 μ g/ μ l. The NE reuptake inhibitor drug desipramine was prepared at a concentration of 25 mg/ml in 0.9% physiological saline for IP injection at a dose of 25 mg/kg.

5.2.4 Procedures

Behavioral testing began one week after surgery and conducted as previously described – one day of habituation to the apparatus, followed by 16 days of single-trials in the drug self-administration runway. Since the experimental manipulation in the experiments involved the application of the neurotoxin during surgery, there were no pretreatments prior to runway testing. Animals were removed from their home cage, each day brought to the runway apparatus, connected to the i.v. drug delivery system, and placed into the start box where, after 5 s, the start door was opened and the trial initiated. Upon entering the goal box, the goal door automatically closed behind the subject (to prevent retracing) and an i.v. infusion of

cocaine was administered. After 5 min, the subjects were removed from the goal box, disconnected from the drug delivery system, and returned to their home cages. As previously stated, catheter patency was maintained by daily i.v. “flushing” of the catheter with 0.1 ml of cefazolin/gentamycin followed by 0.1 ml heparinized saline.

As in previous chapters, after runway testing was complete, animals underwent a behavioral assay for non-specific motoric effects of the treatment. Since these animals had chronic lesions, no baseline tests were conducted, and a between-group analysis used to detect differences in locomotor activity between the treatment groups. Subjects underwent a 30 min testing session during which time the total distance traveled (cm) was measured in 5 min intervals.

5.2.5 Histology

After the conclusion of behavioral testing, animals were euthanized with an overdose of sodium pentobarbital and received transcardiac perfusions of 120ml PBS followed by 120ml 4% PFA. Brain tissue was post fixed overnight in 4% PFA at 4°C before being transferred to 30% sucrose for cryoprotection. Tissue was sliced to a thickness of 40 µm on a freezing microtome and sections containing either the LHb or BNST (Experiments VI and VII, respectively) were stained using immunohistochemistry to visual serotonergic fibers. Antibodies against 5-HT (Rabbit anti-5-HT, Immunostar) itself as well as SERT (rabbit anti-SERT, Immunostar), the serotonin transporter, were both tested. The signal was then amplified using a

biotinylated donkey anti-rabbit secondary antibody, and the slides developed with the ABC reagent kit (Vectastain) and DAB.

5.3 Results

5.3.1. Histology

A number of complications arose during the immunohistochemistry staining procedure which caused this procedure to fail. Initial tests with both 5-HT and SERT antibodies showed some staining of 5-HT fibers, but with an excessive background signal. Multiple subsequent runs of the procedure necessitated the use of significant amounts of brain tissue. Additionally, the hurdles encountered during these tests caused significant delays in processing the tissue, which resulted in the loss of a number of samples due to mold growth. For these reasons, neither the efficacy of the lesion, nor the extent of affected tissue could be verified.

5.3.2 Experiment VI: 5,7-DHT lesion of the LHb

This experiment tested the effects of bilateral intra-LHb microinjections of 5,7-DHT (8.0 $\mu\text{g}/\mu\text{l}/\text{side}$) or vehicle on the runway behavior of animals approaching and entering a goal box associated with the administration of 1.0 mg/kg i.v. cocaine. Group sizes were $n = 19$ for the vehicle group and $n = 21$ for the 5,7-DHT lesion group. Figure 5.1 depicts the mean ($\pm\text{SEM}$) runway performance of both groups of animals during the 16 days of runway testing. A two-factor (Group x Trials) Analysis of Variance (ANOVA) conducted on the start latency data (Figure 5.1, Top panel) revealed a significant main effect of Trials ($F(15,570)=3.221, p < .001$), but no main

effect of Group ($F(1,38)=.377, p = .543$) and no Group x Trial interaction ($F(15,570)=1.009, p = .444$). Thus, all animals, irrespective of group, learned the association between the goal box and drug delivery and displayed an increasing motivation to seek the drug (faster start times) as testing progressed. However, despite the fast start latencies, animals took longer and longer to enter the goal box. Another two-factor (Group x Trial) ANOVA computed on the run time data (Figure 5.1, Middle) confirmed a significant main effect of Trial ($F(15,570)=5.612, p < .001$) but in the opposite direction of start times (see middle panel of Figure 5.2). While the figure suggests the possibility that the 5-HT-LHb lesioned animals were slower to enter the goal box, this effect was not statistically significant; i.e., there was no main effect of Group ($F(1,38)=.897, p = .349$), nor a statistically significant Group x Trial interaction ($F(15,570)=1.039, p = .413$). Analysis of approach-avoidance retreat behavior (Figure 5.1, Bottom panel) similarly revealed a significant main effect of Trials ($F(15,570)=13.558, p < .001$) (when averaged across all animals), subjects tended to make more retreats as testing progressed), but no main effect of Group ($F(1,38)=1.130, p = .295$), nor a Group x Trials interaction ($F(15,570)=1.154, p = .304$). As was the case for run time, the retreat frequency data were suggestive of an *increased* number of approach-avoidance retreats in the lesioned group relative to the vehicle controls, but the results were clearly not-significant and, if anything, were directionally opposite in direction to the predicted/hypothesized outcome.

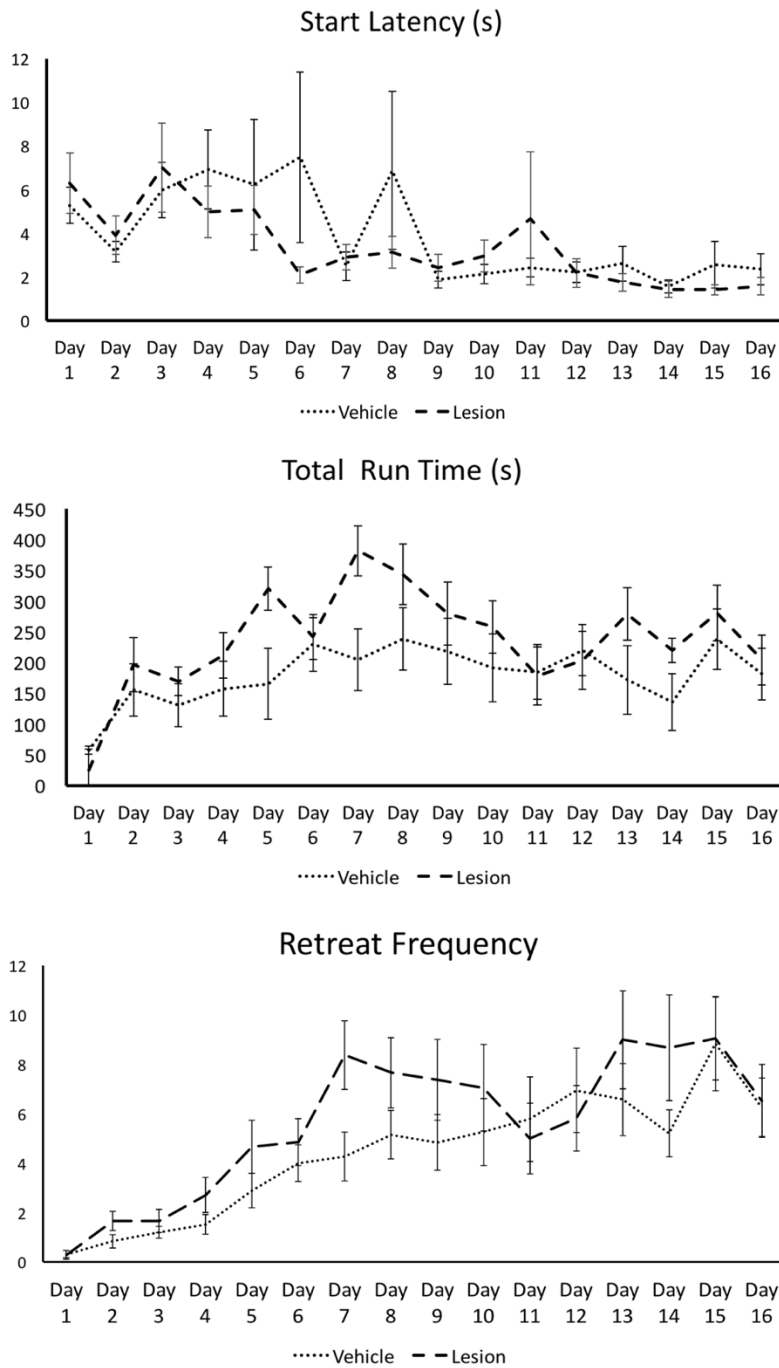

Figure 5.1 Group Mean (\pm SEM) start latencies (top panel), run times (middle panel), and approach-avoidance retreat behavior (bottom panel) of animals running a straight alley once daily for an infusion of 1.0 mg/kg i.v. cocaine after treatment with either 8.0 μ g 5,7-DHT (dashed lines) or vehicle (dotted lines) into the LHb.

5.3.3 Experiment VII: 5,7-DHT Lesion of the BNST

This experiment was conducted in an identical manner to Experiment I, above, but this time the 5-HT lesions were targeted at the BNST. Animals received either 5,7-DHT (8.0 $\mu\text{g}/\mu\text{l}/\text{side}$) or vehicle, $n = 5$ per group, and were subsequently tested in the runway apparatus to assess the development of approach-avoidance retreat behaviors in response to 1.0 mg/kg i.v. cocaine. Figure 5.2 depicts the mean ($\pm\text{SEM}$) group performance during runway testing. A two-factor (Group x Trials) Analysis of Variance (ANOVA) conducted on the start latency data (Figure 5.2, Top panel) failed to show an effect of Trials ($F(15,120)=1.404, p = .156$), or Group ($F(1,8)=.022, p = .887$), or the Group x Trial interaction ($F(15,120)=.659, p = .820$). While there were clearly no group differences in start latency, it was surprising that the reductions observed over trials did not reach statistical significance as both groups left the start box faster by the end of testing than they did at the outset. A paired-samples t-test comparing the start latencies on Day 1 of testing with those on Day 16 just barely reached statistical significance ($t(9)=2.920, p = .048$), indicating that the animals did indeed show an increased motivation to seek cocaine over the course of testing. High within-group variability and small sample sizes may have resulted in inadequate power to observe a statistically reliable effect in the ANOVA.

Despite relatively fast start latencies, animals took longer and longer to enter the goal box. Another two-factor (Group x Trial) ANOVA computed on the run time

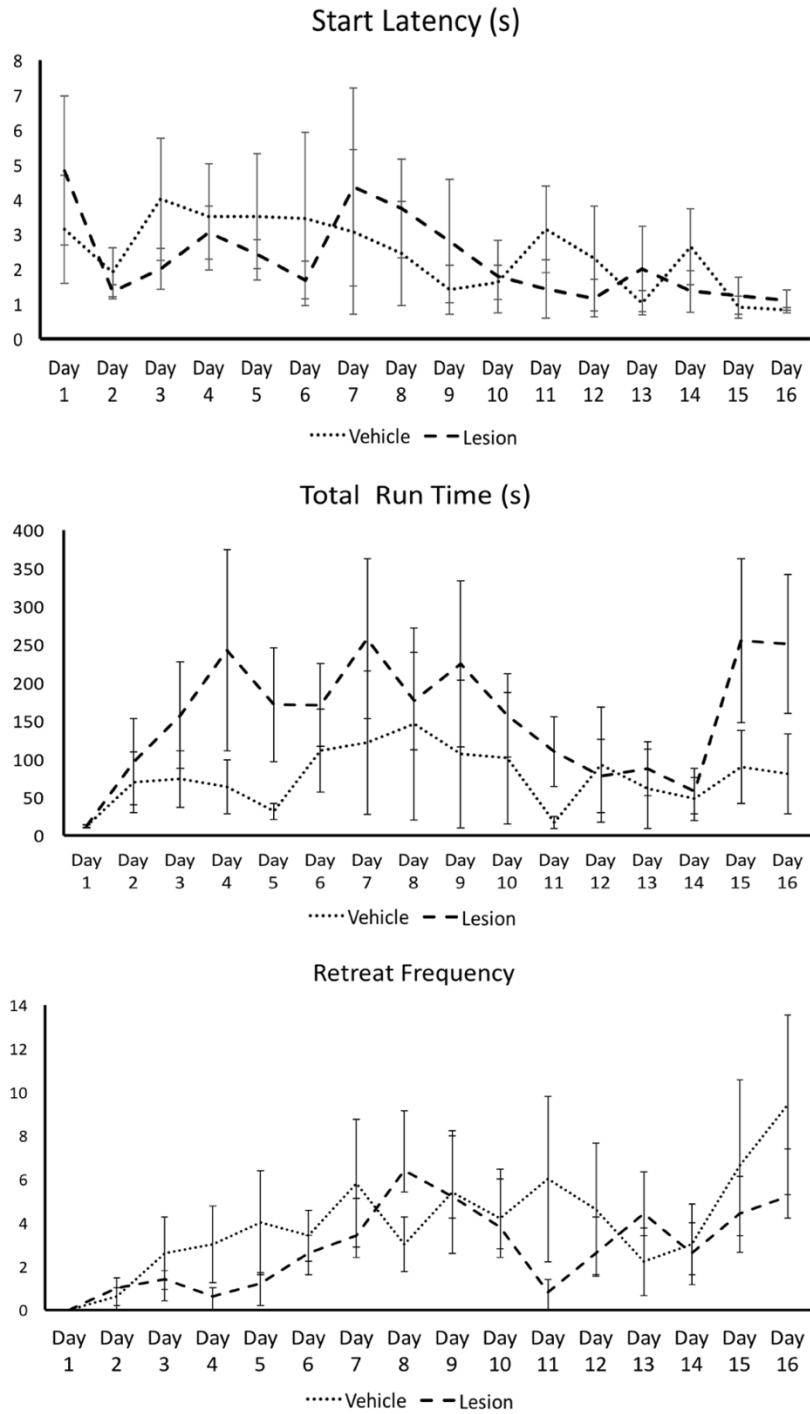

Figure 5.2 Group Mean (\pm SEM) start latencies (top panel), run times (middle panel), and approach-avoidance retreat behavior (bottom panel) of animals running a straight alley once daily for an infusion of 1.0 mg/kg i.v. cocaine after treatment with either 8.0 μ g 5,7-DHT (dashed lines) or vehicle (dotted lines) into the BNST.

data (Figure 5.2, Middle) confirmed a significant main effect of Trial ($F(15,120) = 2.490, p = .003$) reflecting the fact that both groups exhibited longer run times as testing continued. Despite the apparent differences between the lesioned and non-lesioned groups, there was no main effect of Group ($F(1,8)=1.139, p = .317$), nor a statistically significant Group x Trial interaction ($F(15,120)=.996, p = .464$).

The data analyses for approach-avoidance retreat behavior produced results comparable to those obtained for run time (Figure 5.1, Bottom panel) in that there was a significant main effect of Trials ($F(15,120)=2.838, p = .001$), but no main effect of Group ($F(1,8)=.303, p = .597$), nor a Group x Trials interaction ($F(15,120)=.995, p = .465$).

5.3.4 Locomotor Activity Test

The locomotor activity of the animals was observed during a single 30-min test. For clarity, the two vehicle groups were combined and compared to the LHB and BNST lesioned groups (Figure 5.3). The activity data (distance traveled during each 5-min bin) were then analyzed by a two-factor (Group x Time) ANOVA. As the figure clearly depicts, there was a significant main effect of Time ($F(5,245)=96.442, p < .001$), reflecting the fact that on average all animals reduced their activity as testing continued and they habituated to the apparatus. However, once again, there was no main effect of Group ($F(2,49)=1.497, p = .234$), nor a Group x Time interaction ($F(10,245)=1.371, p = .194$), demonstrating that the animals'

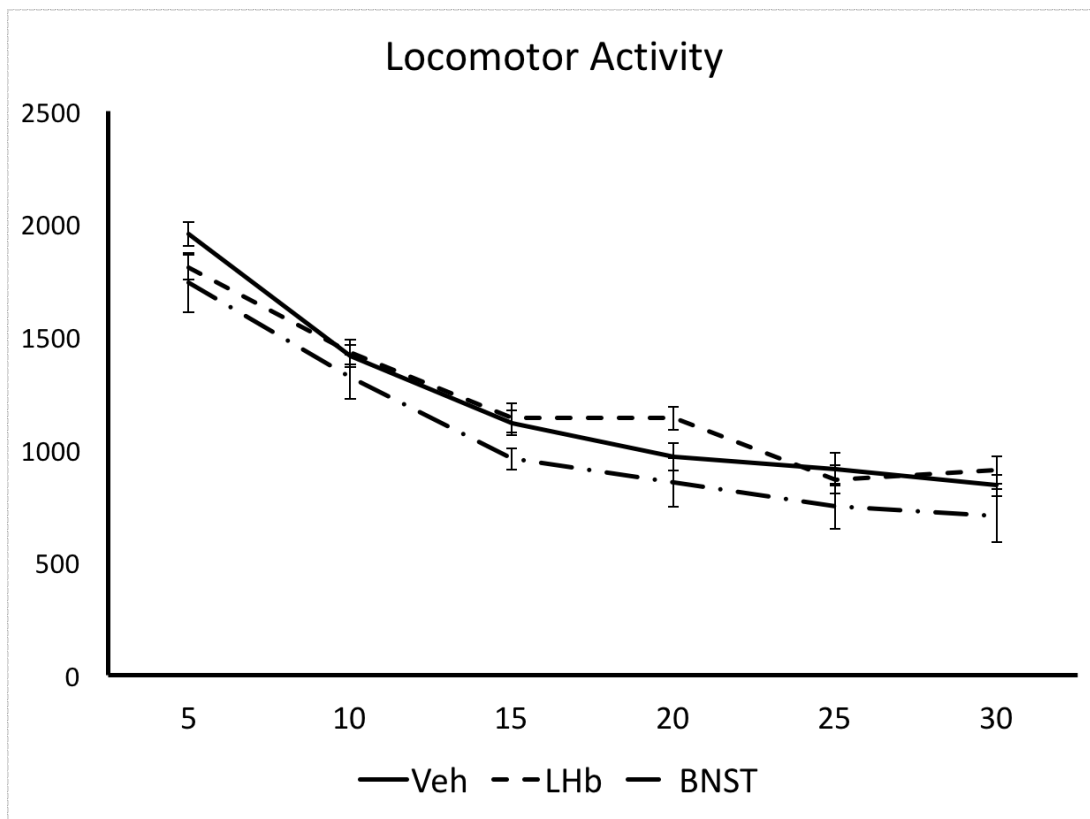

Figure 5.3 Group Mean (\pm SEM) spontaneous locomotor activity of animals who received 5,7-DHT lesions of either the LHb or BNST, and vehicle treated animals (of both regions). The total distance traveled (cm) was recorded over 5-min intervals for a 30-min test session. No group differences in activity were observed.

spontaneous locomotor activity was unaffected by serotonergic lesions of either the LHb or BNST.

5.4 Conclusions

- Animals running the alley for i.v. cocaine and pre-treated with intracranial infusions of vehicle behaved as expected from numerous previous published studies as well as from the results observed in Chapters 3 and 4 – i.e., these subjects exhibited decreases in start latencies and increases in run times and retreat frequencies as testing progressed.
- Unlike the results of prior experiments involving intra-LHb or -BNST applications of the 5-HT_{1B} agonist, CP 94,253, putative lesions of the 5-HT terminals in these two target areas did not reliably alter the runway behavior of animals working for cocaine, nor did the application of the 5-HT neurotoxin 5,7-DHT affect the animals' spontaneous locomotor activity.
- At face value, the failure to obtain statistically significant results with the two lesions experiments described above challenges the hypothesis that 5-HT release within the LHb and BNST is contributing to the anxiogenic response to cocaine, since elimination of the 5-HT terminals ought to have produced effects comparable to a reduction in 5-HT release presumed to have occurred with infusions of CP 94,253. Unfortunately, any firm conclusions are impossible to draw due to difficulties that arose with the histological confirmation of lesion efficacy. The problems stemmed from the use of

antibodies employed for visualizing 5-HT (Rabbit anti-5-HT, Immunostar) itself as well as SERT (Rabbit anti-SERT, Immunostar), the serotonin transporter, both of which failed to produce confirmation of 5-HT neurons in non-lesioned controls. Hence, there was no way to determine whether or not the application of 5,7-DHT produced the selective 5-HT lesions that were intended.

- If, in fact, 5,7-DHT infusions *did* produce the intended 5-HT lesions, and the runway behavior was unaltered by this treatment, then what explanation(s) can one provide for the differential effects of the lesion studies and those observed using the 5-HT_{1B} agonist, CP 94,253? While necessarily speculative in nature, a discussion of this possibility is provided in the Discussion chapter that follows.

Chapter 6: General Discussion

As detailed in Chapter 1, cocaine has been shown to produce dual rewarding and aversive effects in both humans and other animals (Anthony et al., 1989; Costall et al., 1989; Ettenberg et al., 1999; Resnick et al., 1977; Rogerio & Takahashi, 1992; Williamson et al., 1997). These dual and opposing positive/negative effects of cocaine fit well with Solomon & Corbitt's (1974) "opponent-process theory", which states that any affective stimulus (whether positive or negative) will trigger the activation of an opponent process whose function is to return the organism back to affective homeostasis. The experimental results presented within this thesis support this theory and further extend the body of knowledge in two key areas: 1) it builds upon previous research from our laboratory that investigated the role of NE and CRF signaling in the BNST (Ettenberg, Cotten, Brito, Klein, Ohana, Margolin, Wei, & Wenzel, 2015; Wenzel et al., 2014, 2011) and DA signaling within the LHb (Shelton et al., 2016), as well as experiments that have shown a more global role of 5-HT in modulating these dual effects of cocaine (Ettenberg & Bernardi, 2006, 2007; Ettenberg, Ofer, Mueller, Waldroup, Cohen, & Ben-Shahar, 2011), and 2) this thesis identifies a potential neurochemical mechanism for how 5-HT signaling in these two brain regions (the BNST and LHb) contributes to the negative/anxiogenic effects of cocaine.

The bed nucleus of the stria terminalis (BNST)

The experiments described in Chapter 3 explored the role of 5-HT signaling within the BNST in modulating the dual and opposing consequences of the drug. To

accomplish this goal, the impact of 5-HT_{1B} activation was examined on the behavior of animals running a straight alley for a “reward” of i.v. cocaine delivered upon goal-box entry. These results confirm previous findings showing that cocaine-reinforced animals develop a characteristic pattern of retreat behaviors, reflecting an approach/avoidance conflict about entering a goal box with which the subject has formed mixed positive and negative associations (see Ettenberg et al 1999; Ettenberg 2004; Raven et al 2000; Jhou et al 2013). Pretreating animals with a selective 5-HT_{1B} agonist delivered into the BNST significantly decreased expression of retreat behaviors, a result consistent with the hypothesis that serotonergic release within the BNST contributes to and/or modulates the aversive/anxiogenic response to cocaine. This conclusion is further strengthened by the fact that treatment with the autoreceptor agonist did not have a significant effect on the animals’ spontaneous locomotor activity, indicating that the reduction in runway retreat behaviors was not due to a nonspecific sedative effect of the treatment.

Of course, reductions in approach-avoidance conflict (retreats) could conceivably occur in response to a treatment-induced enhancement in the rewarding properties of cocaine (as opposed to a reduction in the negative actions of the drug). Indeed, previous studies on the role of 5-HT_{1B} receptors in drug addiction have demonstrated an involvement of this receptor in increasing the reward value of cocaine (Parsons et al 1998; Filip et al 2010) and amphetamines (Miszkiel et al 2011). More specifically, Filip and colleagues (2010), showed that

intra-VTA injections of a 5-HT_{1B} antagonist impaired cocaine discrimination in a dose-dependent manner, while application of a 5-HT_{1B} agonist enhanced discrimination of lower doses of cocaine. The agonist alone also showed partial substitution for cocaine, suggesting an involvement of these receptors in the subjective effects of cocaine. In the study by Parsons et al (1998), both systemic and intra-ventricular treatment with multiple different 5-HT_{1B} agonists produced operant behaviors that mirror what is seen when increasing the unit dose of cocaine under both a fixed-ratio and progressive-ratio schedule of reinforcement, suggesting 5-HT_{1B} activation produces an increase in the reward value of cocaine. Additionally, viral vector-mediated overexpression of 5-HT_{1B} receptors in the efferent projections from the nucleus accumbens to the VTA, enhanced locomotor sensitization as well as strengthened the development of conditioned place preferences to low doses of cocaine (Neumaier et al 2002). In a study of 5-HT_{1B} knockout mice, these animals showed an enhanced response to cocaine, as well as increases in cocaine self-administration, which lead the authors to propose 5-HT_{1B}-knockout mice as a model of vulnerability to cocaine addiction (Castanon, Scearce-Levie, Lucas, Rocha, & Hen, 2000). So perhaps 5-HT_{1B} applications produced an increase in reward and not a decrease in cocaine-induced anxiety.

However, in the experiments described in Chapters 3 (and 4), while the animals' start latencies (the time it took for subjects to initiate responding by leaving the start box) of animals significantly decreased over trials (suggesting that the

motivation to seek the drug increased as testing progressed), there was no difference in this effect between groups. Thus, there was no evidence that the goal box experience was more rewarding (and hence more motivating) in the groups pretreated with CP 94,253 than in the vehicle control group. Indeed, the fact that the animals' start latencies were unaltered by the infusion of CP 94,253 into the BNST (or LHb), suggests that the motivation to seek the cocaine was unaffected, while the reduction in retreats suggests that the negative consequences of cocaine were reduced. Of course, a selective decrease in the negative properties of cocaine would nevertheless predict a more positive experience for the subject. It therefore seems reasonable to suggest that the enhanced cocaine-reward effects observed by others following administration of 5-HT_{1B} agonists into the VTA might similarly be due to a reduction in the negative/anxiogenic effects of the cocaine as opposed to a direct action on reward circuitry.

Another explanation for the differences in the conclusions drawn in the current thesis and those of the previous studies described above, is the reasonable possibility that serotonergic actions in such distinct brain regions as the BNST, LHb and VTA are involved in different aspects of the response to cocaine. For example, it has been suggested that activation of 5-HT_{1B} receptors on GABAergic neurons of the VTA could lead to a disinhibition of dopamine release through a reduction in the tonic GABA activity within this region (Castanon et al 2000; Filip et al 2003). This would allow for a 5-HT_{1B} mediated potentiation of cocaine's rewarding effects.

Therefore, application of a 5-HT_{1B} agonist to the VTA may indeed increase cocaine reward through the interaction with dopamine, while the same drug acting in the BNST (or LHb) could enhance the *net* reward value via a reduction in the anxiogenic/negative actions of cocaine.

It is also worth noting that, with respect to the BNST, there is evidence of a direct neuronal connection between it and the VTA (Jennings et al 2013; Sparta et al 2013; Adhikari 2014; Stamatakis et al 2014). This projection from the BNST appears to have a prominent role in regulation of VTA dopaminergic cells (Jalabert et al 2009). These projections originate from the ventral BNST and have a strong excitatory connection to the VTA (Aston-Jones et al. 2001; Georges and Aston-Jones 2002). The role of VTA dopamine in reward related behaviors, including cocaine reinforcement, has been well documented (e.g., McBride et al. 1999; Koob 2003; Stuber et al. 2012; George et al. 2012; Jennings et al. 2013; Koob and Volkow 2016). Thus, it seems likely that the BNST can modulate the affective response to cocaine through this pathway. However, because this excitatory vBNST -> VTA projection is necessary for cocaine preference (Sartor and Aston-Jones 2012), and activation of the 5-HT_{1B} receptor produces presynaptic inhibition of glutamatergic and serotonergic inputs (Hammack et al., 2009), one would then expect the present manipulation to reduce activity in the vBNST -> VTA pathway leading to a reduction in the reinforcing properties in cocaine. This effect was not observed (i.e., start latencies continued to improve over trials), thus leading to the conclusion that the

activation of 5-HT_{1B} receptors in the overall BNST leads to a reduction in the anxiogenic effects of cocaine without increasing the rewarding effects. The microinjection methods employed in this study are not precise enough to accurately target specific subregions of the BNST. Nevertheless, as 5-HT is a diffuse modulatory neurotransmitter, the present aim was simply to investigate the effect of reducing overall 5-HT signaling in this region via targeting the presynaptic autoreceptors. Therefore, it is not possible from this investigation to make any claims about subregion specific effects of the manipulation.

Experiment II was conducted to obtain further insight into the behavioral mechanism by which intra-BNST administration of CP 94,253 reduced the animal's approach-avoidance conflict in the runway. Since pretreatment with drugs like diazepam have also been shown to reduce approach-avoidance retreats (Ettenberg and Geist 1991), it is possible that the 5-HT_{1B} agonist pretreatment (Experiment I) was acting as a general anxiolytic that reduced retreats not by interfering with the delayed negative consequences of cocaine, but more simply by reducing the animals' general anxiety prior to each trial. This seems plausible given that experiments with systemic administration of 5-HT_{1B} agonists have demonstrated anxiolytic and antidepressant-like effects (Tatarczyńska et al. 2004; 2005). It was therefore of interest to determine whether BNST application of CP 94,253 *after* the runway trial but *before* the onset of cocaine's negative effects (which have been shown to reach peak levels in rats 15-min post iv injection; see Ettenberg et al 1999;

Knackstedt et al 2002; Jhou et al 2013) would similarly reduce approach-avoidance retreat behaviors in the runway. The observed reduction in runway retreat behaviors produced by this treatment could not, therefore, be easily accounted for by any indirect or nonspecific action of the treatment on either the animals' anxiety prior to the start of testing nor their behavioral capacity since the subjects were running prior to the delivery of either the cocaine or the CP 94,253.

Although there were modest differences in the number of retreats performed by the vehicle groups between Experiments I and II, this was not unexpected given the inherent response variability observed in numerous previous experiments using the runway. Because animals in Experiment II went directly from their home cage to the runway, it is possible that they experienced heightened anxiety at the onset of the test. In Experiment I, there was a delay between animal's removal from their home cage and their placement in the runway during which each received its microinjection. This slight difference in procedure provided animals in Experiment I time to anticipate the runway trial, which could explain why they showed a lower maximum number of retreats. In any event, when taken together, the current results are consistent with the conclusion that the comparable effects of the pre- and post-treatment application of CP 94,253 were due to an alteration of the impact of the delayed negative consequences of cocaine administration.

It is also interesting to note that the vast majority of literature investigating the role of the BNST in mediating the aversive effects of drugs like cocaine has been

focused on drug withdrawal (George, Le Moal, & Koob, 2012; Jalabert, Aston-Jones, Herzog, Manzoni, & Georges, 2009; Koob, 2003, 2008). Indeed, the extended amygdala appears to be a major part of the brain circuitry that mediates stress-induced relapse to drugs of abuse (Erb, 2010; Ventura-Silva et al., 2012). However, the studies described in this thesis highlight a role for the BNST in modulating the negative effects of cocaine after acute administration, and not just after withdrawal from chronic drug exposure. This finding is consistent with previous work from our laboratory which similarly showed a role for the BNST itself (Wenzel et al., 2011), as well as NE signaling within this region (Wenzel et al., 2014) in mediating the acute negative effects of cocaine. Taken together, these findings show that the BNST is not only responsible for the negative effects of cocaine withdrawal, but that it plays a role in the acute negative effects of the drug as well.

Finally, it is fully acknowledged that the current interpretation of these findings is suggestive rather than conclusive and that the precise mechanism(s) through which 5-HT is acting in the BNST to alter the behavioral response to cocaine remain(s) to be elucidated. For example, it has been established that 5-HT_{1B} receptors are not exclusively located on 5-HT pre-synaptic elements -- they also exist as heteroreceptors on the terminals of glutamatergic neurons that synapse within the BNST (Guo and Rainnie 2010). Thus, while there is evidence that the 5-HT_{1B} receptor exists *primarily* on the presynaptic membrane in regions receiving 5-HT projections (Riad et al. 2000), it nevertheless remains to be determined whether the

reductions in retreat behavior observed in the present study are due to CP 94,253's putative inhibitory effects on 5-HT release, or to an impaired functioning of a glutamatergic excitatory "driver" input. That being stated, 5-HT_{1B} heteroreceptors do show a lower sensitivity to 5-HT_{1B} agonists than 5-HT_{1B} autoreceptors (Sarhan and Fillion 1999). Consequently, it may be that the non-dose dependent effect on retreat behavior observed in the present study was due to the loss of specificity to serotonergic autoreceptors. The fact that a typical dose-response curve was not observed suggests that the doses used in this study likely fall on the upper end of the dose range for this drug.

The Lateral Habenula (LHb)

The experiments described in Chapter 4 examined the impact of 5-HT_{1B} receptor stimulation in the LHb on the behavior of animals running a straight alley for i.v. cocaine reinforcement. Much as it did in the BNST (Chapter 3), application of a selective 5-HT_{1B} agonist into the LHb produced no effects on start latency, an increase in run times, and a corresponding dose-dependent decrease in the frequency of runway retreat behaviors, an effect that was reversed by co-administration with a selective 5-HT_{1B} antagonist.

Once again, these results cannot be easily accounted for by some form of nonspecific motoric effects of the treatment, since neither treatment protocol produced alterations in the spontaneous locomotor activity of subjects. Additionally, and as discussed above for the BNST, while one might argue that the observed

reductions in retreat behavior reflect an increase in the rewarding properties of cocaine, to turn the argument on its head, a presumed enhancement in cocaine reward after intraventricular administration of a 5-HT_{1B} agonist, as suggested by Parsons et al. (1998) could in fact have been due to a reduction in the drug's aversive effects, leading to a *net* increase in reward. Indeed, when a 5-HT_{1B} agonist is administered systemically, it would be difficult to tease apart potentially opposing actions stemming from drug effects in different brain regions. Finally, in the current set of LHb experiments, as was the case in Chapter 3 for the BNST experiments, CP 94,253 produced no enhancement of start latencies, which would have been expected if cocaine-reward had been increased. Thus, when taken together, the current findings are consistent with the hypothesis that the observed reductions in approach-avoidance retreat behaviors were due, not to an elevation in the rewarding properties of cocaine, but rather to a reduction in the drug's negative/anxiogenic effects.

But what is the neurobiological basis for the behavioral effects of intra-LHb CP 94,253 in cocaine-reinforced animals? There is ample evidence demonstrating an intimate inverse relationship between the VTA and LHb. Early studies investigating this relationship found that stimulation of the LHb produces an inhibition of VTA DA cell firing (Christoph et al., 1986). It was later shown by Matsumoto & Hikosaka (2007) that this circuit is responsible for encoding an "anti-reward" signal. Their experiments elegantly showed how the LHb responds to both negative outcomes, as

well as the lack of an expected reward, by an increase in its own activity while simultaneously inhibiting the VTA. Likewise, the rewarding conditions that produced strong activations of VTA DA cells also inhibited the activity of LHb neurons (Matsumoto & Hikosaka, 2007). In later research, as described in Chapter 1, these projections from the LHb were found to be glutamatergic and inhibitory to the VTA via activation of GABAergic cells of the RMTg – a region immediately adjacent to the VTA (Jhou, Fields, et al., 2009; Stamatakis & Stuber, 2012). Additionally, the reverse pathway has also been identified using optogenetic methods—a population of presumptively GABAergic VTA neurons that inhibit the LHb and promote reward (Stamatakis et al., 2013). Jhou et al. (2013) have also reported that the initial rewarding effects of cocaine are associated with an inhibition of LHb neurons and that the onset of the delayed anxiogenic response to the drug is directly associated with an increase in LHb activity and a resulting suppression of VTA DA neurons. When viewed in this context, the current findings might suggest a role for 5-HT release within the LHb as a contributing factor to the LHb's modulation of the affective response to cocaine.

In addition to its role in regulating the VTA, the LHb is also one of the major inputs to the dorsal and median raphé 5-HT systems (see Metzger, Bueno, & Lima, 2017 for a recent review). While the LHb has been shown to receive reciprocal projections back from the DRN (Zhao, Zhang, Yang, & Rusak, 2015), the bulk of 5-HT innervation targets the medial habenula (MHb) (Metzger et al., 2017; Morin &

Meyer-Bernstein, 1999; Tchenio et al., 2016; Wagner, Bernard, et al., 2016; Wagner, French, et al., 2016). Analysis of mRNA transcripts in this region suggests that the 5-HT_{1B} receptor has an elevated expression in the LHb versus the MHb (Metzger et al., 2017; Wagner, Bernard, et al., 2016; Wagner, French, et al., 2016), which again support the hypothesis that the observed behavioral effects described in Chapter 4 were due primarily to modulation of the LHb, rather than MHb. However, due to the relatively small size and immediate adjacency of the LHb and MHb, it cannot be conclusively determined with any anatomical precision whether our manipulations produced their effects via modulation of the LHb, MHb, or both structures.

Although most of the research in this area has focused on the LHb, the MHb has also been implicated in modulating the same affective states as the LHb, including drug withdrawal, depression, stress, and anxiety (Viswanath, Carter, Baldwin, Molfese, & Salas, 2014). The MHb has also received a renewed interest for its role in nicotine addiction, due to the discovery that it contains a high concentration of nicotinic ACh receptors and has outputs to areas that regulate ACh release throughout the brain (Viswanath et al., 2014). Clearly there is a need for more research on the MHb and its role in the behavioral effects of drugs of abuse.

The effects of selective lesions of 5-HT terminals in the LHb and BNST

Serotonin appears to have mixed effects in the LHb. On post-synaptic LHb neurons, 5-HT produces primarily stimulatory effects via activation of 5-HT_{2/3} receptors, which enhance cellular depolarization (L.-N. Han, Zhang, Li, Sun, Wang,

Chen, Guo, Zhang, Zhang, & Liu, 2015; Zuo, Zhang, Xie, Gregor, Bekker, & Ye, 2016). 5-HT can also act as an inhibitory signal through activation of inhibitory 5-HT_{1B} heteroreceptors located presynaptically on the glutamatergic inputs to the LHb (Hwang & Chung, 2014; Xie, Zuo, Wu, Li, Wu, Bekker, & Ye, 2016). Additionally, local application of a 5-HT_{1B} agonist into the LHb has been shown to reduce 5-HT release as measured through microdialysis (Adell et al., 2001). Thus, there are two possible mechanisms that could explain the results observed in the current set of LHb experiments. First, it could be that the 5-HT_{1B} agonist is reducing LHb activity indirectly via inhibition of glutamatergic inputs to the LHb; alternatively, these results could be explained by an inhibition of 5-HT release in the LHb via activation of the 5-HT_{1B} autoreceptors localized on the serotonergic fibers innervating this region. The experiments described in Chapter 5 attempted to distinguish between these two possibilities using selective neurotoxic lesions.

Unfortunately, as described above, the lesion experiments suffered from two major (but related) issues: 1) the inability to verify through immunohistochemistry the extent and effectiveness of 5,7-DHT lesions, and 2) the small sample size in the BNST experiment (which was a consequence of our decision to stop testing animals due to the unreliability of the antibodies we employed for visualizing 5-HT and SERT). Ultimately, these issues resulted in an inability to verify whether or not the neurotoxic treatments had in fact produced viable 5-HT lesions. Part of the problem is the paucity of serotonergic fibers in this region. However, we did also look for 5-

HT-positive fibers in other nearby regions (e.g., MHb, striatum, and cerebral cortex) and failed to find them, which led to the conclusion that the IHC staining did not work.

By way of speculation – if in fact the lesions successfully destroyed the 5-HT terminals (as we had planned but were unable to confirm), and this produced no change in the anxiogenic response to cocaine, then the results observed in Chapters 3 and 4 may conceivably have been due to modulation of glutamatergic, rather than serotonergic, inputs to the LHb. As described in Chapter 1, the effects of 5-HT in the LHb are complex, showing both inhibition and excitation (Han et al., 2015; Zuo et al., 2016). If the putative 5,7-DHT lesion and the administration of a 5-HT_{1B} agonist (in Chapter 4) produced different effects on retreat behavior, it is reasonable to conclude that the 5-HT_{1B} agonist effects might have resulted from an inhibition of the glutamatergic drive onto the LHb, and not from a reduction in 5-HT release, as originally proposed. Thus, assuming the lesions were successful, this would imply that the role of 5-HT within the LHb is modulatory in nature, and not critical for the development of approach-avoidance retreat behavior.

The explanation for the failure of the 5-HT lesions in the BNST (Chapter 3) is even more inconclusive due to the high within-group variability, the small sample sizes, and the inability to verify the efficacy of the lesion. Experiment VII was being conducted at the same time as the histology from Experiment VI. When the problem of visualizing the lesions was encountered, the decision was made to not add further

animals to increase group sizes, since it was clear from the LHb lesion experiment that we would be unable to be histologically verify the lesion. By this point, the 5,7-DHT lesion experiments had already represented a year and a half of work. Thus, the decision was made to cease this line of enquiry.

To conclude, while the lesion experiments leave some questions unanswered, the work described in this dissertation makes a number of valuable contributions towards developing a better understanding of the aversive effects of cocaine. First, it demonstrates the importance of serotonin signaling in both the BNST and LHb, two regions that have been associated with anxiety and aversion. The CP 94,253 experiments described in this dissertation join fewer than a half-dozen published reports on the intracranial administration of this compound. Additionally, the studies described in this dissertation are the first, and only, published experiments that use NAS-181 intracranial infusions to block the behavioral effects of a co-administered 5-HT_{1B} agonist. The dissertation, therefore, adds to a growing body of literature about the relationship between serotonin and the aversive effects of cocaine. Taken together, the experiments described herein provide further evidence in support of Solomon & Corbit's (1974) opponent process theory of motivated behavior, as it relates to cocaine. With selective modulation of 5-HT activity in the BNST and LHb, it is possible to partially negate the aversive "B" process, demonstrating that the "A" and "B" processes are indeed dissociable and arise from distinct neuroanatomical networks in the brain.

Limitations and Caveats

One major caveat of this research is the fact that 5-HT release was never measured directly in any experiment. Therefore, it is impossible to say with any certainty whether the 5-HT_{1B} manipulations (in Chapters 3 & 4) actually caused a decrease in 5-HT release. However, microdialysis experiments have shown the efficacy of 5-HT_{1B} selective agonists at reducing 5-HT release within the LHb (Adell et al., 2001). Similar work has also shown that the 5-HT_{1B} antagonist used in this work, NAS-181, can block 5-HT_{1B} mediated suppression of 5-HT release (De Groote et al., 2003). Although these studies provide evidence for a 5-HT_{1B} mediated reduction in 5-HT release, the research presented in this thesis does not include any direct measurements of 5-HT.

A second major caveat of this thesis is that there were no direct observations of 5-HT_{1B} receptor activity or expression made in any experiments. The drugs used to manipulate 5-HT_{1B} activity were given daily, for 17 consecutive days, in each experiment. This dosing regimen may have been sufficient to induce tolerance to the treatment over the course of testing. The treatment may have caused compensatory responses in receptor expression, agonist binding, or recruitment of downstream signaling cascades. Additionally, it is unknown how daily infusions of cocaine may affect this receptor.

Additionally, there is evidence that 5-HT_{1B} heteroreceptors can also regulate the release of other neurotransmitters, including GABA (Hashimoto & Kita, 2008;

Peruzzi & Dut, 2004). So, in addition to regulation of glutamate and 5-HT, the 5-HT_{1B} receptor also regulates inhibitory transmission throughout the brain. Thus, it is possible that manipulations targeted at this receptor produce off target effects on GABA terminal as well.

The 5-HT_{1B} receptor is also constitutively active, a feature that is critical for the axonal targeting and subcellular localization of this receptor (Carrel, Simon, Emerit, Rivals, Letierrier, Biard, Hamon, Darmon, & Lenkei, 2011). Because this receptor's subcellular localization is dependent upon the its activity, it is possible that daily infusions of a 5-HT_{1B} agonist could produces alterations in receptor localization or expression.

Finally, the studies that utilized 5,7-DHT lesions of the serotonergic fibers are also subject to an important caveat: lesioned fibers would also disrupt signaling through any fibers of passage, causing potential off-target effects in regions far from the targeted site. Because 5-HT is a diffuse modulatory system that releases neurotransmitter through a meshwork of varicosities, rather than point-to-point synaptic transmission, even a localized lesion could destroy fibers innervate distant regions. In addition, it is also not known what compensatory changes might occur in response to destruction of 5-HT fibers. It may be possible that the lack of results seen in the lesion experiments of Chapter V could be due to a compensatory response of other neurotransmitter systems attempting to "fill in the gaps" caused by the loss of 5-HT.

Clinical Implications

This work has potential clinical implications, particularly for the treatment of cocaine use disorders. The 5-HT_{1B} receptor represents a potential target for the alleviation of cocaine's negative effects. Unlike for opioid drugs of abuse, there is currently no pharmacotherapy for cocaine use disorder. As shown by the work in this thesis, agonists at the 5-HT_{1B} receptor are effective at reducing the anxiogenic properties of cocaine. For humans, this is a potential avenue for treating relapse. By finding a pharmacotherapeutic drug that alleviates cocaine's negative effects, it may be possible to prevent a person from relapsing. According to the Koob model of addiction, the process of addiction is characterized by cycles of binges and withdrawal, with the aversive effects of withdrawal driving the next drug binge (Koob & Le Moal, 2008).

A recent review article highlights the potential of the 5-HT_{1B} receptor as a target for various psychiatric disorders, including anxiety, depression and substance abuse (Tiger, Varnäs, Okubo, & Lundberg, 2018). The authors make the case for targeting the 5-HT_{1B} receptor, primarily for the treatment of Major Depression, and suggest that the therapeutic benefit seen with typical selective serotonin reuptake inhibitor (SSRI) antidepressants might be due to a downregulation of the 5-HT_{1B} receptor. If this is true, then selective 5-HT_{1B} agonists could show an improved efficacy compared to treatment with the relatively non-selective SSRIs. Additionally,

if this theory is correct, 5-HT_{1B} inverse-agonists may be an entirely new set of potential options for the treatment of depression.

In human studies of cocaine dependence, there have been mixed reports on the efficacy of SSRIs in reducing relapse to the drug, with some studies showing an effect while others do not (Moeller, Schmitz, Steinberg, Green, Reist, Lai, Swann, & Grabowski, 2007). The discrepancy in findings could potentially be due to slight differences in the mechanism of action of various SSRIs. One study in rodents showed that fluoxetine, but not sertraline or citalopram, could potentiate the locomotor response to cocaine (Fletcher, Sinyard, Salsali, & Baker, 2004). However, an important caveat is that SSRIs could increase the toxic effects of cocaine (O'Dell, George, & Ritz, 2000), which may preclude the use of SSRIs in cocaine-dependent patients. Thus, it is clear more research is needed to develop effective tools for the treatment of cocaine dependence.

References

- Abrams, J. K., Johnson, P. L., Hay-Schmidt, A., Mikkelsen, J. D., Shekhar, A., & Lowry, C. A. (2005). Serotonergic systems associated with arousal and vigilance behaviors following administration of anxiogenic drugs. *Neuroscience*, *133*, 983–997. <https://doi.org/10.1016/j.neuroscience.2005.03.025>
- Adell, A., Celada, P., & Artigas, F. (2001). The role of 5-HT 1B receptors in the regulation of serotonin cell firing and release in the rat brain. *Journal of Neurochemistry*, *79*(1), 172–182. <https://doi.org/10.1046/j.1471-4159.2001.00550.x>
- Adhikari, A. (2014). Distributed circuits underlying anxiety. *Frontiers in Behavioral Neuroscience*, *8*(April), 112. <https://doi.org/10.3389/fnbeh.2014.00112>
- Aghajanian, G. K., & Wang, R. Y. (1977). Habenular and other midbrain raphe afferents demonstrated by a modified retrograde tracing technique. *Brain Research*, *122*(2), 229–242. Retrieved from <http://www.ncbi.nlm.nih.gov/pubmed/837230>
- Aizawa, H., Kobayashi, M., Tanaka, S., Fukai, T., & Okamoto, H. (2012). Molecular characterization of the subnuclei in rat habenula. *The Journal of Comparative Neurology*, *520*(18), 4051–4066. <https://doi.org/10.1002/cne.23167>
- Alheid, G. F., & Heimer, L. (1988). New perspectives in basal forebrain organization of special relevance for neuropsychiatric disorders: The striatopallidal,

amygdaloid, and corticopetal components of substantia innominata.

Neuroscience, 27(1), 1–39. [https://doi.org/10.1016/0306-4522\(88\)90217-5](https://doi.org/10.1016/0306-4522(88)90217-5)

Amat, J., Sparks, P. D., Matus-Amat, P., Griggs, J., Watkins, L. R., & Maier, S. F. (2001). The role of the habenular complex in the elevation of dorsal raphe nucleus serotonin and the changes in the behavioral responses produced by uncontrollable stress. *Brain Research*, 917(1), 118–126. Retrieved from <http://www.ncbi.nlm.nih.gov/pubmed/11602236>

Anthony, J. C., Tien, A. Y., & Petronis, K. R. (1989). Epidemiologic evidence on cocaine use and panic attacks. *American Journal of Epidemiology*, 129(3), 543–549. <https://doi.org/10.1093/oxfordjournals.aje.a115166>

Araki, M., McGeer, P. L., & McGeer, E. G. (1984). Retrograde HRP tracing combined with a pharmacohistochemical method for GABA transaminase for the identification of presumptive GABAergic projections to the habenula. *Brain Research*, 304(2), 271–277. Retrieved from <http://www.ncbi.nlm.nih.gov/pubmed/6331587>

Association, A. P. (2013). *Diagnostic and statistical manual of mental disorders (DSM-5®)*.

Baker, P. M., Oh, S. E., Kidder, K. S., & Mizumori, S. J. Y. (2015). Ongoing behavioral state information signaled in the lateral habenula guides choice flexibility in freely moving rats. *Frontiers in Behavioral Neuroscience*, 9, 295. <https://doi.org/10.3389/fnbeh.2015.00295>

- Balcita-Pedicino, J. J., Omelchenko, N., Bell, R., & Sesack, S. R. (2011). The inhibitory influence of the lateral habenula on midbrain dopamine cells: ultrastructural evidence for indirect mediation via the rostromedial mesopontine tegmental nucleus. *The Journal of Comparative Neurology*, *519*(6), 1143–1164.
<https://doi.org/10.1002/cne.22561>
- Basso, A. M., Spina, M., Rivier, J., Vale, W., & Koob, G. F. (1999). Corticotropin-releasing factor antagonist attenuates the “anxiogenic-like” effect in the defensive burying paradigm but not in the elevated plus-maze following chronic cocaine in rats. *Psychopharmacology*, *145*(1), 21–30.
<https://doi.org/10.1007/s002130051028>
- Baumgarten, H. G., Klemm, H. P., Sievers, J., & Schlossberger, H. G. (1982). Dihydroxytryptamines as tools to study the neurobiology of serotonin. *Brain Research Bulletin*, *9*(1–6), 131–150. Retrieved from <http://www.ncbi.nlm.nih.gov/pubmed/7172024>
- Ben-Shahar, O., Posthumus, E. J., Waldroup, S. A., & Ettenberg, A. (2008). Heightened drug-seeking motivation following extended daily access to self-administered cocaine. *Progress in Neuro-Psychopharmacology and Biological Psychiatry*, *32*(3), 863–869. <https://doi.org/10.1016/j.pnpbp.2008.01.002>
- Blanchard, D. C., & Blanchard, R. J. (1999). Cocaine potentiates defensive behaviors related to fear and anxiety. *Neuroscience and Biobehavioral Reviews*, *23*(7), 981–991. Retrieved from <http://www.ncbi.nlm.nih.gov/pubmed/10580312>

- Boschert, U., Ait. Amara, D., Segu, L., & Hen, R. (1994). The mouse 5-hydroxytryptamine_{1B} receptor is localized predominantly on axon terminals. *Neuroscience*, *58*(1), 167–182. [https://doi.org/10.1016/0306-4522\(94\)90164-3](https://doi.org/10.1016/0306-4522(94)90164-3)
- Bromberg-Martin, E. S., & Hikosaka, O. (2011). Lateral habenula neurons signal errors in the prediction of reward information. *Nature Neuroscience*, *14*(9), 1209–1216. <https://doi.org/10.1038/nn.2902>
- Bromberg-Martin, E. S., Matsumoto, M., & Hikosaka, O. (2010). Dopamine in motivational control: rewarding, aversive, and alerting. *Neuron*, *68*(5), 815–834. <https://doi.org/10.1016/j.neuron.2010.11.022>
- Caldecott-Hazard, S., Mazziotta, J., & Phelps, M. (1988). Cerebral correlates of depressed behavior in rats, visualized using ¹⁴C-2-deoxyglucose autoradiography. *The Journal of Neuroscience : The Official Journal of the Society for Neuroscience*, *8*(6), 1951–1961. Retrieved from <http://www.ncbi.nlm.nih.gov/pubmed/3385484>
- Caplan, L. R., Hier, D. B., & Banks, G. (1982). Current concepts of cerebrovascular disease--stroke: stroke and drug abuse. *Stroke*, *13*(6), 869–872. <https://doi.org/10.1161/01.str.13.6.869>
- Carrel, D., Simon, A., Emerit, M. B., Rivals, I., Leterrier, C., Biard, M., ... Lenkei, Z. (2011). Axonal Targeting of the 5-HT_{1B} Serotonin Receptor Relies on Structure-Specific Constitutive Activation. *Traffic*, *12*(11), 1501–1520. <https://doi.org/10.1111/j.1600-0854.2011.01260.x>

- Carroll, K. M., Rounsaville, B. J., & Bryant, K. J. (1993). Alcoholism in treatment-seeking cocaine abusers: clinical and prognostic significance. *Journal of Studies on Alcohol*, *54*(2), 199–208. <https://doi.org/10.15288/jsa.1993.54.199>
- Castanon, N., Searce-Levie, K., Lucas, J. J., Rocha, B., & Hen, R. (2000). Modulation of the effects of cocaine by 5-HT_{1B} receptors: A comparison of knockouts and antagonists. *Pharmacology Biochemistry and Behavior*, *67*(3), 559–566. [https://doi.org/10.1016/S0091-3057\(00\)00389-0](https://doi.org/10.1016/S0091-3057(00)00389-0)
- Chojnacka-Wojcik, E., Klodzinska, A., & Tatarczynska, E. (2005). The anxiolytic-like effect of 5-HT_{1B} receptor ligands in rats: a possible mechanism of action. *J Pharm Pharmacol*, *57*(2), 253–257. <https://doi.org/10.1211/0022357055399>
- Christoph, G. R., Leonzio, R. J., & Wilcox, K. S. (1986). Stimulation of the lateral habenula inhibits dopamine-containing neurons in the substantia nigra and ventral tegmental area of the rat. *The Journal of Neuroscience : The Official Journal of the Society for Neuroscience*, *6*(3), 613–619.
- Cohen, A., Young, R. W., Velazquez, M. a., Groysman, M., Noorbehesht, K., Ben-Shahar, O. M., & Ettenberg, A. (2009). Anxiolytic effects of nicotine in a rodent test of approach-avoidance conflict. *Psychopharmacology*, *204*, 541–549. <https://doi.org/10.1007/s00213-009-1486-7>
- Costall, B., Domeney, A. M., Gerrard, P. A., Horovitz, Z. P., Kelly, M. E., Naylor, R. J., & Tomkins, D. M. (1990). Effects of captopril and SQ29,852 on anxiety-related behaviours in rodent and marmoset. *Pharmacology Biochemistry and Behavior*,

36(1), 13–20. [https://doi.org/10.1016/0091-3057\(90\)90118-2](https://doi.org/10.1016/0091-3057(90)90118-2)

Costall, B., Elizabeth Kelly, M., Naylor, R. J., & Onaivi, E. S. (1989). The actions of nicotine and cocaine in a mouse model of anxiety. *Pharmacology Biochemistry and Behavior*, 33(1), 197–203. [https://doi.org/10.1016/0091-3057\(89\)90450-4](https://doi.org/10.1016/0091-3057(89)90450-4)

Cox, B. J., Ron Norton, G., Swinson, R. P., & Endler, N. S. (1990). Substance abuse and panic-related anxiety: A critical review. *Behaviour Research and Therapy*, 28(5), 385–393. [https://doi.org/10.1016/0005-7967\(90\)90157-e](https://doi.org/10.1016/0005-7967(90)90157-e)

Crespi, L. P. (1942). Quantitative Variation of Incentive and Performance in the White Rat. *The American Journal of Psychology*, 55(4), 467. <https://doi.org/10.2307/1417120>

Cunningham, K. a, Paris, J. M., & Goeders, N. E. (1992a). Chronic cocaine enhances serotonin autoregulation and serotonin uptake binding. *Synapse (New York, N.Y.)*, 11(2), 112–123. <https://doi.org/10.1002/syn.890110204>

Cunningham, K. a, Paris, J. M., & Goeders, N. E. (1992b). Serotonin neurotransmission in cocaine sensitization. *Annals of the New York Academy of Sciences*, 654(409), 117–127. Retrieved from <http://www.ncbi.nlm.nih.gov/pubmed/1321571>

Daly, J., Fuxe, K., & Jonsson, G. (1974). 5,7-Dihydroxytryptamine as a tool for the morphological and functional analysis of central 5-hydroxytryptamine neurons. *Research Communications in Chemical Pathology and Pharmacology*, 7(1), 175–187. Retrieved from <http://www.ncbi.nlm.nih.gov/pubmed/4811447>

- Davis, M. (2006). Neural systems involved in fear and anxiety measured with fear-potentiated startle. *The American Psychologist*, *61*(8), 741–756.
<https://doi.org/10.1037/0003-066X.61.8.741>
- Davis, M., Schlesinger, L. S., & Sorenson, C. A. (1989). Temporal specificity of fear conditioning: Effects of different conditioned stimulus--unconditioned stimulus intervals on the fear-potentiated startle effect. *Journal of Experimental Psychology: Animal Behavior Processes*, *15*(4), 295–310.
<https://doi.org/10.1037//0097-7403.15.4.295>
- Davis, M., Walker, D. L., Miles, L., & Grillon, C. (2010). Phasic vs sustained fear in rats and humans: role of the extended amygdala in fear vs anxiety. *Neuropsychopharmacology : Official Publication of the American College of Neuropsychopharmacology*, *35*(1), 105–135.
<https://doi.org/10.1038/npp.2009.109>
- De Almeida, R. M. M., Rosa, M. M., Santos, D. M., Saft, D. M., Benini, Q., & Miczek, K. a. (2006). 5-HT(1B) receptors, ventral orbitofrontal cortex, and aggressive behavior in mice. *Psychopharmacology*, *185*(4), 441–450.
<https://doi.org/10.1007/s00213-006-0333-3>
- De Groote, L., Klompmakers, A. A., Olivier, B., & Westenberg, H. G. M. (2003). An evaluation of the effect of NAS-181, a new selective 5-HT1B receptor antagonist, on extracellular 5-HT levels in rat frontal cortex. *Naunyn-Schmiedeberg's Archives of Pharmacology*, *367*(2), 89–94.

<https://doi.org/10.1007/s00210-002-0685-0>

De Groote, L., Olivier, B., & Westenberg, H. G. (2002). Extracellular serotonin in the prefrontal cortex is limited through terminal 5-HT_{1B} autoreceptors: A microdialysis study in knockout mice. *Psychopharmacology*, *162*(4), 419–424.

<https://doi.org/10.1007/s00213-002-1117-z>

Deneau, G., Yanagita, T., & Seevers, M. H. (1969). Self-administration of psychoactive substances by the monkey. *Psychopharmacologia*, *16*(1), 30–48.

<https://doi.org/10.1007/bf00405254>

DeVries, A. C., & Pert, A. (1998). Conditioned increases in anxiogenic-like behavior following exposure to contextual stimuli associated with cocaine are mediated by corticotropin-releasing factor. *Psychopharmacology*, *137*(4), 333–340.

<https://doi.org/10.1007/s002130050627>

Dong, H.-W., & Swanson, L. W. (2004). Organization of axonal projections from the anterolateral area of the bed nuclei of the stria terminalis. *The Journal of Comparative Neurology*, *468*(2), 277–298. <https://doi.org/10.1002/cne.10949>

Dyke, C. Van, Barash, P., Jatlow, P., & Byck, R. (1976). Cocaine: plasma concentrations after intranasal application in man. *Science*, *191*(4229), 859–861. Retrieved from <http://www.sciencemag.org/content/191/4229/859.short>

Erb, S. (2010). Evaluation of the relationship between anxiety during withdrawal and stress-induced reinstatement of cocaine seeking. *Progress in Neuro-Psychopharmacology and ...*, *34*, 798–807.

<https://doi.org/10.1016/j.pnpbbp.2009.11.025>

Erb, S., Kayyali, H., & Romero, K. (2006). A study of the lasting effects of cocaine pre-exposure on anxiety-like behaviors under baseline conditions and in response to central injections of corticotropin-releasing factor. *Pharmacology Biochemistry and Behavior*, *85*(1), 206–213.

<https://doi.org/10.1016/j.pbb.2006.08.002>

Erb, S., Shaham, Y., & Stewart, J. (2001). Stress-induced Relapse to Drug Seeking in the Rat; Role of the Bed Nucleus of the Stria Terminalis and Amygdala. *Stress*, *4*(4), 289–303. <https://doi.org/10.3109/10253890109014753>

Ettenberg, A. (2004). Opponent process properties of self-administered cocaine. *Neuroscience and Biobehavioral Reviews*, *27*(8), 721–728.

<https://doi.org/10.1016/j.neubiorev.2003.11.009>

Ettenberg, A. (2009). The runway model of drug self-administration. *Pharmacology Biochemistry and Behavior*, *91*(3), 271–277.

<https://doi.org/10.1016/j.pbb.2008.11.003>

Ettenberg, A., & Bernardi, R. (2006). Anxiolytic-like actions of buspirone in a runway model of intravenous cocaine self-administration. *Pharmacology Biochemistry and Behavior*, *85*(2), 393–399. <https://doi.org/10.1016/j.pbb.2006.09.007>

Ettenberg, A., & Bernardi, R. (2007). Effects of buspirone on the immediate positive and delayed negative properties of intravenous cocaine as measured in the conditioned place preference test. *Pharmacology Biochemistry and Behavior*,

87(1), 171–178. <https://doi.org/10.1016/j.pbb.2007.04.014>

Ettenberg, A., Cotten, S. W., Brito, M. A., Klein, A. K., Ohana, T. A., Margolin, B., ...

Wenzel, J. M. (2015). CRF antagonism within the ventral tegmental area but not the extended amygdala attenuates the anxiogenic effects of cocaine in rats.

Pharmacology, Biochemistry and Behavior, 138, 148–155.

<https://doi.org/10.1016/j.pbb.2015.10.002>

Ettenberg, A., Fomenko, V., Kaganovsky, K., Shelton, K., & Wenzel, J. M. (2015). On

the positive and negative affective responses to cocaine and their relation to drug self-administration in rats. *Psychopharmacology*.

<https://doi.org/10.1007/s00213-015-3873-6>

Ettenberg, A., & Geist, T. (1991). Animal model for investigating the anxiogenic

effects of self-administered cocaine. *Psychopharmacology*, 455–461. Retrieved from <http://link.springer.com/article/10.1007/BF02244244>

Ettenberg, A., & Geist, T. D. (1993). Qualitative and quantitative differences in the

operant runway behavior of rats working for cocaine and heroin reinforcement.

Pharmacology, Biochemistry, and Behavior, 44(1), 191–198. Retrieved from

<http://www.ncbi.nlm.nih.gov/pubmed/8430122>

Ettenberg, A., & McFarland, K. (2002). Effects of haloperidol on cue-induced

autonomic and behavioral indices of heroin reward and motivation.

Psychopharmacology, 168(1–2), 139–145. [https://doi.org/10.1007/s00213-002-](https://doi.org/10.1007/s00213-002-1266-0)

1266-0

- Ettenberg, A., Ofer, O. A., Mueller, C. L., Waldroup, S., Cohen, A., & Ben-Shahar, O. (2011). Inactivation of the dorsal raphé nucleus reduces the anxiogenic response of rats running an alley for intravenous cocaine. *Pharmacology Biochemistry and Behavior*, *97*(4), 632–639. <https://doi.org/10.1016/j.pbb.2010.11.008>
- Ettenberg, A., Ofer, O., & Mueller, C. (2011). Inactivation of the dorsal raphe nucleus reduces the anxiogenic response of rats running an alley for intravenous cocaine. *Pharmacology ...*, *97*(4), 632–639. <https://doi.org/10.1016/j.pbb.2010.11.008>
- Ettenberg, A., Raven, M. a, Danluck, D. a, & Necessary, B. D. (1999). Evidence for opponent-process actions of intravenous cocaine. *Pharmacology, Biochemistry, and Behavior*, *64*(3), 507–512. Retrieved from <http://www.ncbi.nlm.nih.gov/pubmed/10548263>
- Filip, M., Alenina, N., Bader, M., & Przegaliński, E. (2010). Behavioral evidence for the significance of serotonergic (5-HT) receptors in cocaine addiction. *Addiction Biology*, *15*(3), 227–249. <https://doi.org/10.1111/j.1369-1600.2010.00214.x>
- Fletcher, P. J., Korth, K. M., & Chambers, J. W. (1999). Selective destruction of brain serotonin neurons by 5,7-dihydroxytryptamine increases responding for a conditioned reward. *Psychopharmacology*, *147*(3), 291–299. Retrieved from <http://www.ncbi.nlm.nih.gov/pubmed/10639688>

- Fletcher, P. J., Sinyard, J., Salsali, M., & Baker, G. B. (2004). Fluoxetine, but not sertraline or citalopram, potentiates the locomotor stimulant effect of cocaine: possible pharmacokinetic effects. *Psychopharmacology*, *174*(3), 406–413. <https://doi.org/10.1007/s00213-003-1747-9>
- Freedman, L., & Shi, C. (2001). Monoaminergic innervation of the macaque extended amygdala. *Neuroscience*, *104*(4), 1067–1084. Retrieved from <http://www.sciencedirect.com/science/article/pii/S0306452201001579>
- Friedman, A., Lax, E., Dikshtein, Y., Abraham, L., Flaumenhaft, Y., Sudai, E., ... Yadid, G. (2010). Electrical stimulation of the lateral habenula produces enduring inhibitory effect on cocaine seeking behavior. *Neuropharmacology*, *59*(6), 452–459. <https://doi.org/10.1016/j.neuropharm.2010.06.008>
- Fuxe, K., & Jonsson, G. (1974). Further mapping of central 5-hydroxytryptamine neurons: studies with the neurotoxic dihydroxytryptamines. *Advances in Biochemical Psychopharmacology*, *10*, 1–12. Retrieved from <http://www.ncbi.nlm.nih.gov/pubmed/4846539>
- Gao, D. M., Hoffman, D., & Benabid, A. L. (1996). Simultaneous recording of spontaneous activities and nociceptive responses from neurons in the pars compacta of substantia nigra and in the lateral habenula. *The European Journal of Neuroscience*, *8*(7), 1474–1478. Retrieved from <http://www.ncbi.nlm.nih.gov/pubmed/8758954>
- Gawin, F. H. (1986). Abstinence Symptomatology and Psychiatric Diagnosis in

- Cocaine Abusers. *Archives of General Psychiatry*, 43(2), 107.
<https://doi.org/10.1001/archpsyc.1986.01800020013003>
- Geist, T. D., & Ettenberg, A. (1990). A Simple Method for Studying Intravenous Drug Reinforcement in a Runway. *Pharmacology Biochemistry and Behavior*, 36, 703–706. Retrieved from
<http://www.sciencedirect.com/science/article/pii/009130579090278P>
- Geist, T. D., & Ettenberg, A. (1997). Concurrent positive and negative goalbox events produce runway behaviors comparable to those of cocaine-reinforce rats. *Pharmacology Biochemistry and Behavior*, 57(1–2), 145–150.
[https://doi.org/10.1016/S0091-3057\(96\)00300-0](https://doi.org/10.1016/S0091-3057(96)00300-0)
- George, O., Le Moal, M., & Koob, G. F. (2012). Allostasis and addiction: role of the dopamine and corticotropin-releasing factor systems. *Physiology & Behavior*, 106(1), 58–64. <https://doi.org/10.1016/j.physbeh.2011.11.004>
- Gill, M. J., Ghee, S. M., Harper, S. M., & See, R. E. (2013). Inactivation of the lateral habenula reduces anxiogenic behavior and cocaine seeking under conditions of heightened stress. *Pharmacology, Biochemistry, and Behavior*, 111, 24–29.
<https://doi.org/10.1016/j.pbb.2013.08.002>
- Good, C. H., Wang, H., Chen, Y.-H., Mejias-Aponte, C. A., Hoffman, A. F., & Lupica, C. R. (2013). Dopamine D4 receptor excitation of lateral habenula neurons via multiple cellular mechanisms. *The Journal of Neuroscience : The Official Journal of the Society for Neuroscience*, 33(43), 16853–16864.

<https://doi.org/10.1523/JNEUROSCI.1844-13.2013>

- Gottesfeld, Z. (1983). Origin and distribution of noradrenergic innervation in the habenula: a neurochemical study. *Brain Research*, 275(2), 299–304. Retrieved from <http://www.ncbi.nlm.nih.gov/pubmed/6354358>
- Gracy, K. (2001). Opiate Withdrawal-Induced Fos Immunoreactivity in the Rat Extended Amygdala Parallels the Development of Conditioned Place Aversion. *Neuropsychopharmacology*, 24(2), 152–160. [https://doi.org/10.1016/s0893-133x\(00\)00186-x](https://doi.org/10.1016/s0893-133x(00)00186-x)
- Gradman, A. H. (1988). Cardiac effects of cocaine: a review. *Yale J Biol Med*, 61(2), 137–147. Retrieved from http://www.ncbi.nlm.nih.gov/entrez/query.fcgi?cmd=Retrieve&db=PubMed&dopt=Citation&list_uids=3043926
- Grant, B. F., & Harford, T. C. (1990). Concurrent and simultaneous use of alcohol with cocaine: results of national survey. *Drug and Alcohol Dependence*, 25(1), 97–104. [https://doi.org/10.1016/0376-8716\(90\)90147-7](https://doi.org/10.1016/0376-8716(90)90147-7)
- Gruber, C., Kahl, A., Lebenheim, L., Kowski, A., Dittgen, A., & Veh, R. W. (2007). Dopaminergic projections from the VTA substantially contribute to the mesohabenular pathway in the rat. *Neuroscience Letters*, 427(3), 165–170. <https://doi.org/10.1016/j.neulet.2007.09.016>
- Guo, J.-D., Hammack, S. E., Hazra, R., Levita, L., & Rainnie, D. G. (2009). Bi-directional modulation of bed nucleus of stria terminalis neurons by 5-HT: molecular

expression and functional properties of excitatory 5-HT receptor subtypes.

Neuroscience, 164(4), 1776–1793.

<https://doi.org/10.1016/j.neuroscience.2009.09.028>

Guzman, D., & Ettenberg, A. (2004). Heroin attenuates the negative consequences of

cocaine in a runway model of self-administration. *Pharmacology Biochemistry*

and Behavior, 79(2), 317–324. <https://doi.org/10.1016/j.pbb.2004.08.009>

Hamlin, A. S., Buller, K. M., Day, T. A., & Osborne, P. B. (2004). Effect of naloxone-

precipitated morphine withdrawal on c-fos expression in rat corticotropin-

releasing hormone neurons in the paraventricular hypothalamus and extended

amygdala. *Neuroscience Letters*, 362(1), 39–43.

<https://doi.org/10.1016/j.neulet.2004.02.033>

Hammack, S. E., Guo, J.-D., Hazra, R., Dabrowska, J., Myers, K. M., & Rainnie, D. G.

(2009). The response of neurons in the bed nucleus of the stria terminalis to

serotonin: implications for anxiety. *Progress in Neuro-Psychopharmacology &*

Biological Psychiatry, 33(8), 1309–1320.

<https://doi.org/10.1016/j.pnpbp.2009.05.013>

Hamner, M. B. (1993). PTSD and Cocaine Abuse. *Psychiatric Services*, 44(6), 591–592.

<https://doi.org/10.1176/ps.44.6.591>

Han, D. D., & Gu, H. H. (2006). Comparison of the monoamine transporters from

human and mouse in their sensitivities to psychostimulant drugs. *BMC*

Pharmacology, 6, 6. <https://doi.org/10.1186/1471-2210-6-6>

- Han, L.-N., Zhang, L., Li, L.-B., Sun, Y.-N., Wang, Y., Chen, L., ... Liu, J. (2015). Activation of serotonin(2C) receptors in the lateral habenular nucleus increases the expression of depression-related behaviors in the hemiparkinsonian rat. *Neuropharmacology*, *93*, 68–79. <https://doi.org/10.1016/j.neuropharm.2015.01.024>
- Harris, G. C., & Aston-Jones, G. (1993). β -adrenergic antagonists attenuate withdrawal anxiety in cocaine-and morphine-dependent rats. *Psychopharmacology*, *113*(1), 131–136. <https://doi.org/10.1007/bf02244345>
- Hashimoto, K., & Kita, H. (2008). Serotonin activates presynaptic and postsynaptic receptors in rat globus pallidus. *Journal of Neurophysiology*, *99*(4), 1723–1732. <https://doi.org/10.1152/jn.01143.2007>
- Hazra, R., Guo, J. D., Dabrowska, J., & Rainnie, D. G. (2012). Differential distribution of serotonin receptor subtypes in BNST(ALG) neurons: modulation by unpredictable shock stress. *Neuroscience*, *225*, 9–21. <https://doi.org/10.1016/j.neuroscience.2012.08.014>
- Heimer, L. (2003). A New Anatomical Framework for Neuropsychiatric Disorders and Drug Abuse. *American Journal of Psychiatry*, (October), 1726–1739. Retrieved from <http://journals.psychiatryonline.org/article.aspx?articleid=176443>
- Hennigan, K., D'Ardenne, K., & McClure, S. M. (2015). Distinct midbrain and habenula pathways are involved in processing aversive events in humans. *The Journal of Neuroscience : The Official Journal of the Society for Neuroscience*,

35(1), 198–208. <https://doi.org/10.1523/JNEUROSCI.0927-14.2015>

Herkenham, M., & Nauta, W. J. (1977). Afferent connections of the habenular nuclei in the rat. A horseradish peroxidase study, with a note on the fiber-of-passage problem. *The Journal of Comparative Neurology*, 173(1), 123–146.

<https://doi.org/10.1002/cne.901730107>

Herkenham, M., & Nauta, W. J. (1979). Efferent connections of the habenular nuclei in the rat. *The Journal of Comparative Neurology*, 187(1), 19–47.

<https://doi.org/10.1002/cne.901870103>

Herman, J. P., Figueiredo, H., Mueller, N. K., Ulrich-Lai, Y., Ostrander, M. M., Choi, D.

C., & Cullinan, W. E. (2003). Central mechanisms of stress integration: hierarchical circuitry controlling hypothalamo–pituitary–adrenocortical responsiveness. *Frontiers in Neuroendocrinology*, 24(3), 151–180.

<https://doi.org/10.1016/j.yfrne.2003.07.001>

Hikosaka, O. (2010). The habenula: from stress evasion to value-based decision-making. *Nature Reviews. Neuroscience*, 11(7), 503–513.

<https://doi.org/10.1038/nrn2866>

Hikosaka, O., Sesack, S. R., Lecourtier, L., & Shepard, P. D. (2008). Habenula :

Crossroad between the Basal Ganglia and the Limbic System, 28(46), 11825–11829. <https://doi.org/10.1523/JNEUROSCI.3463-08.2008>

Hill, S. Y., & Powell, B. J. (1976). Cocaine and morphine self-administration: Effects of differential rearing. *Pharmacology Biochemistry and Behavior*, 5(6), 701–704.

[https://doi.org/10.1016/0091-3057\(76\)90315-4](https://doi.org/10.1016/0091-3057(76)90315-4)

Hitchcock, J. M., & Davis, M. (1986). Lesions of the amygdala, but not of the cerebellum or red nucleus, block conditioned fear as measured with the potentiated startle paradigm. *Behavioral Neuroscience*, *100*(1), 11–22.

<https://doi.org/10.1037//0735-7044.100.1.11>

Hitchcock, J. M., & Davis, M. (1991). Efferent pathway of the amygdala involved in conditioned fear as measured with the fear-potentiated startle paradigm.

Behavioral Neuroscience, *105*(6), 826–842. <https://doi.org/10.1037//0735-7044.105.6.826>

Hong, S., & Hikosaka, O. (2008). The globus pallidus sends reward-related signals to the lateral habenula. *Neuron*, *60*(4), 720–729.

<https://doi.org/10.1016/j.neuron.2008.09.035>

Hull, C. L. (1932). The goal-gradient hypothesis and maze learning. *Psychological Review*, *39*(1), 25–43. <https://doi.org/10.1037/h0072640>

Hull, C. L. (1934a). The concept of the habit-family hierarchy, and maze learning. Part I. *Psychological Review*, *41*(1), 33–54. <https://doi.org/10.1037/h0070758>

Hull, C. L. (1934b). The rat's speed-of-locomotion gradient in the approach to food. *Journal of Comparative Psychology*, *17*(3), 393–422.

<https://doi.org/10.1037/h0071299>

Hwang, E. K., & Chung, J. M. (2014). 5HT1B receptor-mediated pre-synaptic depression of excitatory inputs to the rat lateral habenula.

Neuropharmacology, 81, 153–165.

<https://doi.org/10.1016/j.neuropharm.2014.01.046>

Izumi, T., Ohmura, Y., Futami, Y., Matsuzaki, H., Kubo, Y., Yoshida, T., & Yoshioka, M.

(2012). Effects of serotonergic terminal lesion in the amygdala on conditioned fear and innate fear in rats. *European Journal of Pharmacology*, 696(1–3), 89–95. <https://doi.org/10.1016/j.ejphar.2012.09.028>

Jalabert, M., Aston-Jones, G., Herzog, E., Manzoni, O., & Georges, F. (2009). Role of

the bed nucleus of the stria terminalis in the control of ventral tegmental area dopamine neurons. *Progress in Neuro-Psychopharmacology and Biological Psychiatry*, 33(8), 1336–1346. <https://doi.org/10.1016/j.pnpbp.2009.07.010>

Jhou, T. C., Fields, H. L., Baxter, M. G., Saper, C. B., & Holland, P. C. (2009). The

Rostromedial Tegmental Nucleus (RMTg), a GABAergic Afferent to Midbrain Dopamine Neurons, Encodes Aversive Stimuli and Inhibits Motor Responses. *Neuron*, 61(5), 786–800. <https://doi.org/10.1016/j.neuron.2009.02.001>

Jhou, T. C., Geisler, S., Marinelli, M., Degarmo, B. A., & Zahm, D. S. (2009). The

mesopontine rostromedial tegmental nucleus: A structure targeted by the lateral habenula that projects to the ventral tegmental area of Tsai and substantia nigra compacta. *The Journal of Comparative Neurology*, 513(6), 566–596. <https://doi.org/10.1002/cne.21891>

Jhou, T. C., Good, C. H., Rowley, C. S., Xu, S.-P., Wang, H., Burnham, N. W., ...

Ikemoto, S. (2013). Cocaine drives aversive conditioning via delayed activation

- of dopamine-responsive habenular and midbrain pathways. *The Journal of Neuroscience : The Official Journal of the Society for Neuroscience*, 33(17), 7501–7512. <https://doi.org/10.1523/JNEUROSCI.3634-12.2013>
- Ji, H., & Shepard, P. D. (2007). Lateral Habenula Stimulation Inhibits Rat Midbrain Dopamine Neurons through a GABAA Receptor-Mediated Mechanism. *Journal of Neuroscience*, 27(26), 6923–6930. <https://doi.org/10.1523/jneurosci.0958-07.2007>
- Jin, C., Araki, H., Nagata, M., Suemaru, K., Shibata, K., Kawasaki, H., ... Gomita, Y. (2003). Withdrawal-induced c-Fos expression in the rat centromedial amygdala 24h following a single morphine exposure. *Psychopharmacology*, 1(1), 1–1. <https://doi.org/10.1007/s00213-004-1844-4>
- Johnson, P. L., Molosh, A., Fitz, S. D., Arendt, D., Deehan, G. A., Federici, L. M., ... Shekhar, A. (2015). Pharmacological depletion of serotonin in the basolateral amygdala complex reduces anxiety and disrupts fear conditioning. *Pharmacology Biochemistry and Behavior*, 138(4), 174–179. <https://doi.org/10.1016/j.pbb.2015.09.021>
- Johnston, J. B. (1923). Further contributions to the study of the evolution of the forebrain. *The Journal of Comparative Neurology*, 35(5), 337–481. <https://doi.org/10.1002/cne.900350502>
- Kash, T. L., Pleil, K. E., Marcinkiewicz, C. A., Lowery-gionta, E. G., Crowley, N., Mazzone, C., ... Mcelligott, Z. A. (2015). Neuropeptide Regulation of Signaling

and Behavior in the BNST. *Molecules and Cells*, 38(1), 1–13.

Kim, S.-Y., Adhikari, A., Lee, S. Y., Marshel, J. H., Kim, C. K., Mallory, C. S., ...

Deisseroth, K. (2013). Diverging neural pathways assemble a behavioural state from separable features in anxiety. *Nature*, 496(7444), 219–223.

<https://doi.org/10.1038/nature12018>

Knackstedt, L. A., & Ettenberg, A. (2005). Ethanol consumption reduces the adverse consequences of self-administered intravenous cocaine in rats.

Psychopharmacology, 178(2–3), 143–150. <https://doi.org/10.1007/s00213-004-1996-2>

Knackstedt, L. A., Samimi, M. M., & Ettenberg, A. (2002). Evidence for opponent-process actions of intravenous cocaine and cocaethylene. *Pharmacology*

Biochemistry and Behavior, 72(4), 931–936. [https://doi.org/10.1016/S0091-3057\(02\)00764-5](https://doi.org/10.1016/S0091-3057(02)00764-5)

Koe, B. K., Nielsen, J. a, Macor, J. E., & Heym, J. (1992). Biochemical and behavioral studies of the 5-HT_{1B} receptor agonist, CP-94, 253. *Drug Development Research*, 26, 241–250.

Koob, G. F. (2003). Neuroadaptive mechanisms of addiction: studies on the extended amygdala. *European Neuropsychopharmacology*, 13(6), 442–452.

<https://doi.org/10.1016/j.euroneuro.2003.08.005>

Koob, G. F. (2008). A Role for Brain Stress Systems in Addiction. *Neuron*, 59(Table 2), 11–34. <https://doi.org/10.1016/j.neuron.2008.06.012>

- Koob, G. F., & Le Moal, M. (2008). Review. Neurobiological mechanisms for opponent motivational processes in addiction. *Philosophical Transactions of the Royal Society of London. Series B, Biological Sciences*, 363(1507), 3113–3123. <https://doi.org/10.1098/rstb.2008.0094>
- Kowski, A. B., Veh, R. W., & Weiss, T. (2009). Dopaminergic activation excites rat lateral habenular neurons in vivo. *Neuroscience*, 161(4), 1154–1165. <https://doi.org/10.1016/j.neuroscience.2009.04.026>
- Lammel, S., Lim, B. K., Ran, C., Huang, K. W., Betley, M. J., Tye, K. M., ... Malenka, R. C. (2012). Input-specific control of reward and aversion in the ventral tegmental area. *Nature*, 491(7423), 212–217. <https://doi.org/10.1038/nature11527>
- Lathers, C. M., Tyau, L. S. Y., Spino, M. M., & Agarwal, I. (1988). Cocaine-Induced Seizures, Arrhythmias and Sudden Death. *The Journal of Clinical Pharmacology*, 28(7), 584–593. <https://doi.org/10.1002/j.1552-4604.1988.tb03181.x>
- Lecca, S., Meye, F. J., & Mamei, M. (2014). The lateral habenula in addiction and depression: An anatomical, synaptic and behavioral overview. *European Journal of Neuroscience*, 39(7), 1170–1178. <https://doi.org/10.1111/ejn.12480>
- Lecourtier, L., DeFrancesco, A., & Moghaddam, B. (2008). Differential tonic influence of lateral habenula on prefrontal cortex and nucleus accumbens dopamine release. *European Journal of Neuroscience*, 27(7), 1755–1762. <https://doi.org/10.1111/j.1460-9568.2008.06130.x>
- Li, B., Piriz, J., Mirrione, M., Chung, C., Proulx, C. D., Schulz, D., ... Malinow, R. (2011).

Synaptic potentiation onto habenula neurons in the learned helplessness model of depression. *Nature*, 470(7335), 535–539.

<https://doi.org/10.1038/nature09742>

Lidov, H. G. W., & Molliver, M. E. (1982). An immunohistochemical study of serotonin neuron development in the rat: Ascending pathways and terminal fields. *Brain Research Bulletin*, 8(4), 389–430. [https://doi.org/10.1016/0361-9230\(82\)90077-6](https://doi.org/10.1016/0361-9230(82)90077-6)

Luo, X. F., Zhang, B. L., Li, J. C., Yang, Y. Y., Sun, Y. F., & Zhao, H. (2015). Lateral habenula as a link between dopaminergic and serotonergic systems contributes to depressive symptoms in Parkinson's disease. *Brain Research Bulletin*, 110, 40–46. <https://doi.org/10.1016/j.brainresbull.2014.11.006>

Macedo, C. E., Castilho, V. M., de Souza e Silva, M. A., & Brandão, M. L. (2002). Dual 5-HT mechanisms in basolateral and central nuclei of amygdala in the regulation of the defensive behavior induced by electrical stimulation of the inferior colliculus. *Brain Research Bulletin*, 59(3), 189–195. Retrieved from <http://www.ncbi.nlm.nih.gov/pubmed/12431748>

Martin, B., & Ross, L. E. (1964). Effects of consummatory response punishment on consummatory and runway behavior. *Journal of Comparative and Physiological Psychology*, 58(2), 243–247. <https://doi.org/10.1037/h0041368>

Matsumoto, M., & Hikosaka, O. (2007). Lateral habenula as a source of negative reward signals in dopamine neurons. *Nature*, 447(7148), 1111–1115.

<https://doi.org/10.1038/nature05860>

Matsumoto, M., & Hikosaka, O. (2009). Representation of negative motivational value in the primate lateral habenula. *Nature Neuroscience*, *12*(1), 77–84.

<https://doi.org/10.1038/nn.2233>

Metzger, M., Bueno, D., & Lima, L. B. (2017). The lateral habenula and the serotonergic system. *Pharmacology Biochemistry and Behavior*, (January).

<https://doi.org/10.1016/j.pbb.2017.05.007>

Meye, F. J., Lecca, S., Valentinova, K., & Mameli, M. (2013). Synaptic and cellular profile of neurons in the lateral habenula. *Frontiers in Human Neuroscience*, *7*,

860. <https://doi.org/10.3389/fnhum.2013.00860>

Miller, N. E. (1944). Experimental studies of conflict.

Moeller, F. G., Schmitz, J. M., Steinberg, J. L., Green, C. M., Reist, C., Lai, L. Y., ...

Grabowski, J. (2007). Citalopram combined with behavioral therapy reduces cocaine use: A double-blind, placebo-controlled trial. *American Journal of Drug and Alcohol Abuse*, *33*(3), 367–378.

<https://doi.org/10.1080/00952990701313686>

Mogenson, G., Jones, D., & Yim, C. (1980). From motivation to action: Functional interface between the limbic system and the motor system. *Progress in Neurobiology*, *14*(2–3), 69–97. [https://doi.org/10.1016/0301-0082\(80\)90018-0](https://doi.org/10.1016/0301-0082(80)90018-0)

Morin, L. P., & Meyer-Bernstein, E. L. (1999). The ascending serotonergic system in the hamster: Comparison with projections of the dorsal and median raphe

nuclei. *Neuroscience*, 91(1), 81–105. [https://doi.org/10.1016/S0306-4522\(98\)00585-5](https://doi.org/10.1016/S0306-4522(98)00585-5)

Mucha, R. F., Van Der Kooy, D., O'Shaughnessy, M., & Bucenieks, P. (1982). Drug reinforcement studied by the use of place conditioning in rat. *Brain Research*, 243(1), 91–105. [https://doi.org/10.1016/0006-8993\(82\)91123-4](https://doi.org/10.1016/0006-8993(82)91123-4)

Müller, C. P., & Huston, J. P. (2006). Determining the region-specific contributions of 5-HT receptors to the psychostimulant effects of cocaine. *Trends in Pharmacological Sciences*, 27(2), 105–112. <https://doi.org/10.1016/j.tips.2005.12.003>

Murphy, C. A., DiCamillo, A. M., Haun, F., & Murray, M. (1996). Lesion of the habenular efferent pathway produces anxiety and locomotor hyperactivity in rats: a comparison of the effects of neonatal and adult lesions. *Behavioural Brain Research*, 81(1–2), 43–52. Retrieved from <http://www.ncbi.nlm.nih.gov/pubmed/8950000>

Nelson, A. J. D., Thur, K. E., Marsden, C. a, & Cassaday, H. J. (2012). Opposing effects of 5,7-DHT lesions to the core and shell of the nucleus accumbens on the processing of irrelevant stimuli. *The International Journal of Neuropsychopharmacology / Official Scientific Journal of the Collegium Internationale Neuropsychopharmacologicum (CINP)*, 15(4), 485–496. <https://doi.org/10.1017/S1461145711000599>

O'Dell, L. E., George, F. R., & Ritz, M. C. (2000). Antidepressant drugs appear to

enhance cocaine-induced toxicity. *Experimental and Clinical Psychopharmacology*, 8(1), 133–141. <https://doi.org/10.1037//1064-1297.8.1.133>

Olmos, J., & Heimer, L. (1999). The Concepts of the Ventral Striatopallidal System and Extended Amygdala. *Annals of the New York Academy of Sciences*, 877(1 ADVANCING FRO), 1–32. <https://doi.org/10.1111/j.1749-6632.1999.tb09258.x>

Omelchenko, N., Bell, R., & Sesack, S. R. (2009). Lateral habenula projections to dopamine and GABA neurons in the rat ventral tegmental area. *The European Journal of Neuroscience*, 30(7), 1239–1250. <https://doi.org/10.1111/j.1460-9568.2009.06924.x>

Ootsuka, Y., & Mohammed, M. (2015). Activation of the habenula complex evokes autonomic physiological responses similar to those associated with emotional stress. *Physiological Reports*, 3(2). <https://doi.org/10.14814/phy2.12297>

Paine, T. A., Jackman, S. L., & Olmstead, M. C. (2002). Cocaine-induced anxiety: alleviation by diazepam, but not buspirone, dimenhydrinate or diphenhydramine. *Behavioural Pharmacology*, 13(7), 511–523. <https://doi.org/10.1097/00008877-200211000-00001>

Paxinos, G., & Watson, C. R. (2007). *The Rat Brain in Stereotaxic Coordinates*. Academic Press, San Diego, 3rd.

Perrine, S. A., Sheikh, I. S., Nwaneshiudu, C. A., Schroeder, J. A., & Unterwald, E. M. (2008). Withdrawal from chronic administration of cocaine decreases delta

opioid receptor signaling and increases anxiety- and depression-like behaviors in the rat. *Neuropharmacology*, 54(2), 355–364.

<https://doi.org/10.1016/j.neuropharm.2007.10.007>

Peruzzi, D., & Dut, A. (2004). GABA, serotonin and serotonin receptors in the rat inferior colliculus. *Brain Research*, 998(2), 247–250.

<https://doi.org/10.1016/j.brainres.2003.10.059>

Phillipson, O. T., & Griffith, A. C. (1980). The neurones of origin for the mesohabenular dopamine pathway. *Brain Research*, 197(1), 213–218. Retrieved from <http://www.ncbi.nlm.nih.gov/pubmed/7397554>

Quina, L. A., Tempest, L., Ng, L., Harris, J. A., Ferguson, S., Jhou, T. C., & Turner, E. E. (2015). Efferent pathways of the mouse lateral habenula. *The Journal of Comparative Neurology*, 523(1), 32–60. <https://doi.org/10.1002/cne.23662>

Raven, M. a, Necessary, B. D., Danluck, D. a, & Ettenberg, a. (2000). Comparison of the reinforcing and anxiogenic effects of intravenous cocaine and cocaethylene. *Experimental and Clinical Psychopharmacology*, 8(1), 117–124.

<https://doi.org/10.1037/1064-1297.8.1.117>

Reith, M. E. A., Meisler, B. E., Sershen, H., & Lajtha, A. (1986). Structural requirements for cocaine congeners to interact with dopamine and serotonin uptake sites in mouse brain and to induce stereotyped behavior. *Biochemical Pharmacology*, 35(7), 1123–1129. [https://doi.org/10.1016/0006-](https://doi.org/10.1016/0006-2952(86)90148-6)

[2952\(86\)90148-6](https://doi.org/10.1016/0006-2952(86)90148-6)

- Resnick, R. B., Kestenbaum, R. S., & Schwartz, L. K. (1977). Acute systemic effects of cocaine in man: a controlled study by intranasal and intravenous routes. *Science (New York, N.Y.)*, *195*(4279), 696–698.
<https://doi.org/10.1126/science.841307>
- Rogério, R., & Takahashi, R. N. (1992). Anxiogenic properties of cocaine in the rat evaluated with the elevated plus-maze. *Pharmacology, Biochemistry, and Behavior*, *43*(2), 631–633. Retrieved from
<http://www.ncbi.nlm.nih.gov/pubmed/1438502>
- Rohsenow, D. J., Martin, R. A., Eaton, C. A., & Monti, P. M. (2007). Cocaine Craving as a Predictor of Treatment Attrition and Outcomes After Residential Treatment for Cocaine Dependence. *Journal of Studies on Alcohol and Drugs*, *68*(5), 641–648. <https://doi.org/10.15288/jsad.2007.68.641>
- Rudoy, C. A., & Van Bockstaele, E. J. (2007). Betaxolol, a selective β 1-adrenergic receptor antagonist, diminishes anxiety-like behavior during early withdrawal from chronic cocaine administration in rats. *Progress in Neuro-Psychopharmacology and Biological Psychiatry*, *31*(5), 1119–1129.
<https://doi.org/10.1016/j.pnpbp.2007.04.005>
- Sahuque, L. L., Kullberg, E. F., Mcgeehan, A. J., Kinder, J. R., Hicks, M. P., Blanton, M. G., ... Olive, M. F. (2006). Anxiogenic and aversive effects of corticotropin-releasing factor (CRF) in the bed nucleus of the stria terminalis in the rat: role of CRF receptor subtypes. *Psychopharmacology*, *186*(1), 122–132.

<https://doi.org/10.1007/s00213-006-0362-y>

Sari, Y., Lefèvre, K., Bancila, M., Quignon, M., Miquel, M. C., Langlois, X., ... Vergé, D. (1997). Light and electron microscopic immunocytochemical visualization of 5-HT1B receptors in the rat brain. *Brain Research*, 760, 281–286.

[https://doi.org/10.1016/S0006-8993\(97\)00400-9](https://doi.org/10.1016/S0006-8993(97)00400-9)

Sarnyai, Z., Bíró, É., Gardi, J., Vecsernyés, M., Julesz, J., & Telegdy, G. (1995). Brain corticotropin-releasing factor mediates 'anxiety-like' behavior induced by cocaine withdrawal in rats. *Brain Research*, 675(1–2), 89–97.

[https://doi.org/10.1016/0006-8993\(95\)00043-p](https://doi.org/10.1016/0006-8993(95)00043-p)

Schweimer, J., Fendt, M., & Schnitzler, H.-U. (2005). Effects of clonidine injections into the bed nucleus of the stria terminalis on fear and anxiety behavior in rats. *European Journal of Pharmacology*, 507(1–3), 117–124.

<https://doi.org/10.1016/j.ejphar.2004.11.044>

Sena, L. M., Bueno, C., Pobbe, R. L. H., Andrade, T. G. C. S., Zangrossi, H., & Viana, M. B. (2003). The dorsal raphe nucleus exerts opposed control on generalized anxiety and panic-related defensive responses in rats. *Behavioural Brain Research*, 142, 125–133. [https://doi.org/10.1016/S0166-4328\(02\)00399-6](https://doi.org/10.1016/S0166-4328(02)00399-6)

Serper, M. R., Alpert, M., Richardson, N. A., Dickson, S., Allen, M. H., & Werner, A. (1995). Clinical effects of recent cocaine use on patients with acute schizophrenia. *The American Journal of Psychiatry*, 152(10), 1464–1469.

<https://doi.org/10.1176/ajp.152.10.1464>

- Shaham, Y., Shalev, U., Lu, L., de Wit, H., & Stewart, J. (2003). The reinstatement model of drug relapse: history, methodology and major findings. *Psychopharmacology*, *168*(1–2), 3–20. <https://doi.org/10.1007/s00213-002-1224-x>
- Sheehan, M. F., Sheehan, D. V., Torres, A., Coppola, A., & Francis, E. (1991). Snorting benzodiazepines. *The American Journal of Drug and Alcohol Abuse*, *17*(4), 457–468. Retrieved from <http://www.ncbi.nlm.nih.gov/pubmed/1684083>
- Shelton, K., Bogyo, K., Schick, T., & Ettenberg, A. (2016). Pharmacological modulation of lateral habenular dopamine D2 receptors alters the anxiogenic response to cocaine in a runway model of drug self-administration. *Behavioural Brain Research*, *310*, 42–50. <https://doi.org/10.1016/j.bbr.2016.05.002>
- Shepard, P. D., Holcomb, H. H., & Gold, J. M. (2006). The Presence of Absence: Habenular Regulation of Dopamine Neurons and the Encoding of Negative Outcomes, *32*(3), 417–421. <https://doi.org/10.1093/schbul/sbj083>
- Simon, P., Dupuis, R., & Costentin, J. (1994). Thigmotaxis as an index of anxiety in mice. Influence of dopaminergic transmissions. *Behavioural Brain Research*, *61*(1), 59–64. Retrieved from <http://www.ncbi.nlm.nih.gov/pubmed/7913324>
- Skagerberg, G., Lindvall, O., & Björklund, A. (1984). Origin, course and termination of the mesohabenular dopamine pathway in the rat. *Brain Research*, *307*(1–2), 99–108. Retrieved from <http://www.ncbi.nlm.nih.gov/pubmed/6087992>
- Smith, N. (1960). An empirical determination of an approach gradient. *Journal of*

- Comparative and Physiological Psychology*, 53, 63–67. Retrieved from <http://www.ncbi.nlm.nih.gov/pubmed/13832106>
- Solomon, R. L., & Corbit, J. D. (1974). An opponent-process theory of motivation. I. Temporal dynamics of affect. *Psychological Review*, 81(2), 119–145. <https://doi.org/10.1037/h0036128>
- Sorge, R. E., & Stewart, J. (2005). The contribution of drug history and time since termination of drug taking to footshock stress-induced cocaine seeking in rats. *Psychopharmacology*, 183(2), 210–217. <https://doi.org/10.1007/s00213-005-0160-y>
- Spotts, J. V., & Shontz, F. C. (1984). Drug-induced ego states. I. Cocaine: phenomenology and implications. *The International Journal of the Addictions*, 19(2), 119–151. Retrieved from <http://www.ncbi.nlm.nih.gov/pubmed/6724760>
- Spyraki, C., Fibiger, H. C., & Phillips, A. G. (1982). Cocaine-induced place preference conditioning: lack of effects of neuroleptics and 6-hydroxydopamine lesions. *Brain Research*, 253(1–2), 195–203. Retrieved from <http://www.ncbi.nlm.nih.gov/pubmed/6817851>
- Stamatakis, A. M., Jennings, J. H., Ung, R. L., Blair, G. a, Weinberg, R. J., Neve, R. L., ... Stuber, G. D. (2013). A unique population of ventral tegmental area neurons inhibits the lateral habenula to promote reward. *Neuron*, 80(4), 1039–1053. <https://doi.org/10.1016/j.neuron.2013.08.023>

- Stamatakis, A. M., & Stuber, G. D. (2012). Activation of lateral habenula inputs to the ventral midbrain promotes behavioral avoidance. *Nature Neuroscience*, *15*(8), 1105–1107. <https://doi.org/10.1038/nn.3145>
- Stenfors, C., Yu, H., & Ross, S. B. (2000). Enhanced 5-HT metabolism and synthesis rate by the new selective r5-HT1B receptor antagonist, NAS-181 in the rat brain. *Neuropharmacology*, *39*(4), 553–560. [https://doi.org/10.1016/S0028-3908\(99\)00173-2](https://doi.org/10.1016/S0028-3908(99)00173-2)
- Stephenson-Jones, M., Floros, O., Robertson, B., & Grillner, S. (2012). Evolutionary conservation of the habenular nuclei and their circuitry controlling the dopamine and 5-hydroxytryptophan (5-HT) systems. *Proceedings of the National Academy of Sciences of the United States of America*, *109*(3), E164-73. <https://doi.org/10.1073/pnas.1119348109>
- Su, Z. I., Wenzel, J., Baird, R., & Ettenberg, A. (2011). Comparison of self-administration behavior and responsiveness to drug-paired cues in rats running an alley for intravenous heroin and cocaine. *Psychopharmacology*, *214*, 769–778. <https://doi.org/10.1007/s00213-010-2088-0>
- Sutherland, R. J. (1982). The dorsal diencephalic conduction system: a review of the anatomy and functions of the habenular complex. *Neuroscience and Biobehavioral Reviews*, *6*(1), 1–13. Retrieved from <http://www.ncbi.nlm.nih.gov/pubmed/7041014>
- Sziray, N., Kuki, Z., Nagy, K. M., Markó, B., Kompagne, H., & Lévy, G. (2010). Effects

of single and simultaneous lesions of serotonergic and noradrenergic pathways on open-space and bright-space anxiety-like behavior in two animal models.

Behavioural Brain Research, 209(1), 93–98.

<https://doi.org/10.1016/j.bbr.2010.01.019>

Tatarczynska, E. (2004). Effects of a selective 5-HT_{1B} receptor agonist and antagonists in animal models of anxiety and depression. *Behavioural ...*, 523–534. Retrieved from [http://journals.lww.com/behaviouralpharm/Abstract/2004/12000/Effects_of_a_selective_5-HT_{1B}receptor_agonist_and.1.aspx](http://journals.lww.com/behaviouralpharm/Abstract/2004/12000/Effects_of_a_selective_5-HT1B_receptor_agonist_and.1.aspx)

Tchenio, A., Valentinova, K., & Mameli, M. (2016). Can the Lateral Habenula Crack the Serotonin Code? *Frontiers in Synaptic Neuroscience*, 8(October), 1–7.

<https://doi.org/10.3389/fnsyn.2016.00034>

The Economic Costs of Drug Abuse in the United States: 1992–2002. (n.d.).

PsycEXTRA Dataset. American Psychological Association (APA).

<https://doi.org/10.1037/e404842005-001>

Thornton, E. W., & Davies, C. (1991). A water-maze discrimination learning deficit in the rat following lesion of the habenula. *Physiology & Behavior*, 49(4), 819–822.

Retrieved from <http://www.ncbi.nlm.nih.gov/pubmed/1881990>

Thornton, E. W., & Evans, J. A. (1984). The effects of lesions of the habenula nucleus on lever press behaviour during a tandem operant schedule with contrasting response requirements. *Behavioural Brain Research*, 12(3), 327–334. Retrieved

from <http://www.ncbi.nlm.nih.gov/pubmed/6466437>

- Tian, J., & Uchida, N. (2015). Habenula Lesions Reveal that Multiple Mechanisms Underlie Dopamine Prediction Errors. *Neuron*, *87*(6), 1304–1316.
<https://doi.org/10.1016/j.neuron.2015.08.028>
- Tiger, M., Varnäs, K., Okubo, Y., & Lundberg, J. (2018). The 5-HT1B receptor - a potential target for antidepressant treatment. *Psychopharmacology*, *235*(5), 1317–1334. <https://doi.org/10.1007/s00213-018-4872-1>
- Tomaiuolo, M., Gonzalez, C., Medina, J. H., & Piriz, J. (2014). Lateral Habenula determines long-term storage of aversive memories. *Frontiers in Behavioral Neuroscience*, *8*, 170. <https://doi.org/10.3389/fnbeh.2014.00170>
- Ullsperger, M., & Cramon, D. Y. Von. (2003). Error Monitoring Using External Feedback : Specific Roles of the Habenular Complex , the Reward System , and the Cingulate Motor Area Revealed by Functional Magnetic Resonance Imaging, *23*(10), 4308–4314.
- Ulrich-Lai, Y. M., & Herman, J. P. (2009). Neural regulation of endocrine and autonomic stress responses. *Nature Reviews. Neuroscience*, *10*(6), 397–409.
<https://doi.org/10.1038/nrn2647>
- Veiga, C., & Miczek, K. (2007). Effect of 5-HT1B receptor agonists injected into the prefrontal cortex on maternal aggression in rats. *Brazilian Journal of ...*, *40*, 825–830. Retrieved from http://www.scielo.br/scielo.php?pid=S0100-879X2007000600012&script=sci_arttext&tlng=es

Velasquez, K. M., Molfese, D. L., & Salas, R. (2014). The role of the habenula in drug addiction. *Frontiers in Human Neuroscience*, 8(March), 174.

<https://doi.org/10.3389/fnhum.2014.00174>

Ventura-Silva, A. P., Pêgo, J. M., Sousa, J. C., Marques, A. R., Rodrigues, A. J., Marques, F., ... Sousa, N. (2012). Stress shifts the response of the bed nucleus of the stria terminalis to an anxiogenic mode. *The European Journal of Neuroscience*, 36(10), 3396–3406.

<https://doi.org/10.1111/j.1460-9568.2012.08262.x>

Viswanath, H., Carter, A. Q., Baldwin, P. R., Molfese, D. L., & Salas, R. (2014). The medial habenula: still neglected. *Frontiers in Human Neuroscience*, 7(January), 1–6.

<https://doi.org/10.3389/fnhum.2013.00931>

Wagner, F., Bernard, R., Derst, C., French, L., & Veh, R. W. (2016). Microarray analysis of transcripts with elevated expressions in the rat medial or lateral habenula suggest fast GABAergic excitation in the medial habenula and habenular involvement in the regulation of feeding and energy balance. *Brain Structure and Function*, 221(9), 4663–4689.

<https://doi.org/10.1007/s00429-016-1195-z>

Wagner, F., French, L., & Veh, R. W. (2016). Transcriptomic-anatomic analysis of the mouse habenula uncovers a high molecular heterogeneity among neurons in the lateral complex, while gene expression in the medial complex largely obeys subnuclear boundaries. *Brain Structure and Function*, 221(1), 39–58.

<https://doi.org/10.1007/s00429-014-0891-9>

Walker, D. L., & Davis, M. (1997). Double dissociation between the involvement of the bed nucleus of the stria terminalis and the central nucleus of the amygdala in startle increases produced by conditioned versus unconditioned fear. *The Journal of Neuroscience : The Official Journal of the Society for Neuroscience*, *17*(23), 9375–9383. Retrieved from <http://www.ncbi.nlm.nih.gov/pubmed/9364083>

Walsh, S. L., & Cunningham, K. a. (1997). Serotonergic mechanisms involved in the discriminative stimulus, reinforcing and subjective effects of cocaine. *Psychopharmacology*, *130*(1), 41–58. Retrieved from <http://www.ncbi.nlm.nih.gov/pubmed/9089847>

Watson, S., & Man, M. S. (2000). Serotonin, stress and corticoids. *Journal of Psychopharmacology (Oxford, England)*, *14*(2), 419–421. <https://doi.org/10.1177/026988110001400415>

Wenzel, J. M., Cotten, S. W., Dominguez, H. M., Lane, J. E., Shelton, K., Su, Z.-I., & Ettenberg, A. (2014). Noradrenergic β -receptor antagonism within the central nucleus of the amygdala or bed nucleus of the stria terminalis attenuates the negative/anxiogenic effects of cocaine. *The Journal of Neuroscience : The Official Journal of the Society for Neuroscience*, *34*(10), 3467–3474. <https://doi.org/10.1523/JNEUROSCI.3861-13.2014>

Wenzel, J. M., Waldroup, S. A., Haber, Z. M., Su, Z.-I., Ben-Shahar, O., & Ettenberg, A.

- (2011). Effects of lidocaine-induced inactivation of the bed nucleus of the stria terminalis, the central or the basolateral nucleus of the amygdala on the opponent-process actions of self-administered cocaine in rats. *Psychopharmacology*, 217(2), 221–230. <https://doi.org/10.1007/s00213-011-2267-7>
- Williamson, S., Gossop, M., Powis, B., Griffiths, P., Fountain, J., & Strang, J. (1997). Adverse effects of stimulant drugs in a community sample of drug users. *Drug and Alcohol Dependence*, 44, 87–94. [https://doi.org/10.1016/S0376-8716\(96\)01324-5](https://doi.org/10.1016/S0376-8716(96)01324-5)
- Xie, G., Zuo, W., Wu, L., Li, W., Wu, W., Bekker, A., & Ye, J.-H. (2016). Serotonin modulates glutamatergic transmission to neurons in the lateral habenula. *Scientific Reports*, 6(April), 23798. <https://doi.org/10.1038/srep23798>
- Yang, X. M., Gorman, a L., Dunn, a J., & Goeders, N. E. (1992). Anxiogenic effects of acute and chronic cocaine administration: neurochemical and behavioral studies. *Pharmacology, Biochemistry, and Behavior*, 41(3), 643–650. Retrieved from <http://www.ncbi.nlm.nih.gov/pubmed/1584846>
- Zhao, H., Zhang, B. L., Yang, S. J., & Rusak, B. (2015). The role of lateral habenula-dorsal raphe nucleus circuits in higher brain functions and psychiatric illness. *Behavioural Brain Research*, 277, 89–98. <https://doi.org/10.1016/j.bbr.2014.09.016>
- Zuo, W., Chen, L., Wang, L., & Ye, J.-H. (2013). Cocaine facilitates glutamatergic

transmission and activates lateral habenular neurons. *Neuropharmacology*, *70*, 180–189. <https://doi.org/10.1016/j.neuropharm.2013.01.008>

Zuo, W., Zhang, Y., Xie, G., Gregor, D., Bekker, A., & Ye, J. H. (2016). Serotonin stimulates lateral habenula via activation of the post-synaptic serotonin 2/3 receptors and transient receptor potential channels. *Neuropharmacology*, *101*, 449–459. <https://doi.org/10.1016/j.neuropharm.2015.10.012>