

UC Santa Barbara

Journal of Astronomy in Culture

Title

In Search of the St. Louis Mound Group: Archaeoastronomic and Landscape Archaeology Implications

Permalink

<https://escholarship.org/uc/item/3xs1p7xc>

Journal

Journal of Astronomy in Culture, 2(1)

ISSN

2473-4888

Author

Romain, William Francis

Publication Date

2023-06-29

DOI

10.5070/AC3.1338

Copyright Information

This work is made available under the terms of a Creative Commons Attribution License, available at <https://creativecommons.org/licenses/by/4.0/>

Peer reviewed

In Search of the St. Louis Mound Group: Archaeoastronomic and Landscape Archaeology Implications

William F. Romain

Indiana University, Museum of Archaeology and Anthropology

Abstract:

The Cahokia Mound Group in Illinois, USA, is acknowledged as the largest Native American city north of Mexico. It flourished during the Mississippian Period. Cahokia, however, was only one of three complexes in the immediate area. Located across the Mississippi River from Cahokia, the St. Louis Mound Group was part of the larger complex. The St. Louis Mound Group featured at least 25 earthen mounds including the so-called Big Mound that contained dozens of human burials.

In the 1800s the St. Louis Mound Group was leveled to allow for urban expansion. Few records are in existence documenting the location or other details concerning the group. As a result, an important part of prehistory seems lost.

In this paper the likely location for the St. Louis Mound Group is identified using survey plats from the 1850s, early lithographs and other data. Findings are assessed for astronomic alignments and landscape relationships, with possible cosmological implications noted.

Keywords: St. Louis Mound Group, Big Mound, caves, solstice, Mississippian, Cahokia

Introduction

As a general rule it is not a good idea to use old maps for archaeoastronomic assessments. On the other hand, as explained by Ruggles (2015a, p. 417), “In many cases, it may not be necessary to make survey measurements in the field at all, if sufficiently accurate data are retrievable from site plans or maps, although one must beware potential errors...”. In some cases, such as the St. Louis Mound Group, the investigator is left with no alternative but to use old maps because the site has been completely leveled.

Mitigating the St. Louis situation is that several survey plats from the 1800s show the mounds. As discussed below, there are good reasons to believe that these plats are quite accurate. There are also helpful lithographs and drawings. Using these data it is possible to plot the location for the St. Louis Mound Group with high analytic confidence.

I am not the first investigator who has attempted to locate the mound group. Over the years several efforts have been made (e.g., Baker in Leach 2017, p. 88; Leach 2017, p. 101; St. Louis Museum of Science and Natural History in Marshall 1992, Fig. 16). The figures just noted were made by superimposing either an artist’s sketch of the mound group (based on Peale and Say (1862) or the Peale and Say map over Google Earth Pro imagery (Baker) or city maps (Leach). The problem is that, as discussed below, the Peale and Say map is not entirely accurate and not georeferenced to existing features.

As a consequence, although interesting and useful for generating hypotheses, these illustrations are not sufficient for archaeoastronomic assessments.

In 1987 cultural resource management archaeologists under contract to the U.S. Army Corps of Engineers produced a map summarizing their historic properties reconnaissance that included estimates for mound locations (Rogers and Pulcher 1987, p. 20). The map is at a small scale and is based on a combination of the Peale and Say map, secondary sources (e.g., a 1904 sketch map by David I. Bushnell likely made decades after most of the core group had been leveled) and one 1800s survey plat showing the Big Mound. The locations for the mounds on the west side of the core group as represented by Rogers and Pulcher do not comport with the survey plats I have examined — i.e., survey plats from 1852 showing the west side mounds that Rogers and Pulcher apparently did not have since they only mention the Big Mound plat (#3332).

To my knowledge, the present investigation is the only one to use the highly accurate 1852 survey plats discussed below in combination with GIS (graphic information systems) data, Google Earth Pro and supportive historic documents to locate the mounds.

Analyses of the data just mentioned suggest that elements of the St. Louis Mound Group were intentionally oriented to the cardinal directions, celestial events and certain topographic features. My alignment hypotheses originate from review of a site map made in 1819. Recognizing patterns similar to those found elsewhere among Native American earthworks I thought it might be productive to further investigate.

The paper begins with a brief introduction to the St. Louis Mound Group. This is followed by a methods section wherein several 19th century maps and lithographs are assessed relative to modern data. Next archaeoastronomic findings are presented. Alignments to the cardinal directions, solstices, and Milky Way are identified. This is followed by a discussion concerning landscape features associated with the complex. These features include an extensive network of caves, sinkholes and subterranean passages as well as the nearby Mississippi River. Lastly, cosmological implications of above-noted relationships are considered. (In the pages that follow, distances are given in feet in order to maintain consistency with 19th century records, with metric measurements in parentheses.)

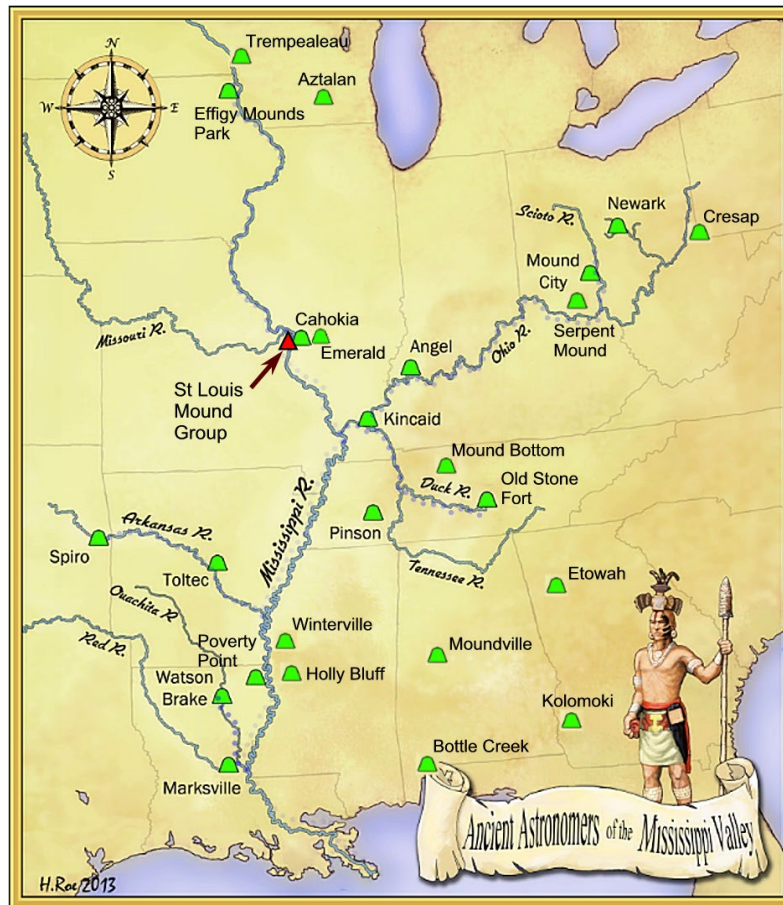

Figure 1. Schematic map by Herb Roe showing locations of selected sites in the Eastern Woodlands. Annotation showing location for St. Louis Mound Group by the present author (Base map commissioned by present author, copyright Herb Roe, used with permission).

The St. Louis Mound Group

One of the best-known and largest mound groups in the eastern United States is the Cahokia site, in Illinois (Fig. 1). About 6.5 miles (10.5 km) to the west-south-west of Cahokia, however, across the Mississippi River, there once existed another large mound complex. Known as the St. Louis Mound Group – in recognition of its location within the city limits of St. Louis, Missouri, this complex was comprised of at least 25 earthen mounds built by people of the Mississippian culture between ca. A.D. 1000 and A.D. 1400 (Leach, 2017; Marshall, 1992). Unfortunately (and with the exception of one mound south of the main group) all above-ground traces of the St. Louis Mound Group were obliterated by urban development during the 1800s.

The St. Louis Mound Group is located about 18 miles (29 km) south of the confluence of the Missouri and Mississippi rivers, on the north side of St. Louis. The complex extends along the second terrace of the Mississippi River. The center of the complex is about 1210 feet (370 m) west of the west bank of the Mississippi River, at an elevation of about 480 feet (146.3 m) MSL (above mean sea level). This situates the group roughly 90 feet (27.4 m) above today's normal water level for the Mississippi

River — which is about 379 feet (115.5 m) (MSL). Unlike Cahokia (at an elevation ca. 415 feet [216.1 m] MSL), the St. Louis Mound Group was not likely to be flooded. (Elevation data from USGS Topographic map Granite City IL-MO 1998, North American Datum 1927; also see FEMA Flood Insurance Rate Map Number 2903850068C.)

As discussed later, the mound group is located in an area of carbonate karst (limestone and dolomite) extending along either side of the Mississippi River from north of St. Louis, near the Missouri River, south to Cape Girardeau, Missouri (Panno et al., 1999). The area is permeated by caves and sinkholes. In fact before they were filled-in, St. Louis boasted of having more caves than any other city in the United States. The caves were large and extensive and used in the 1800s by St. Louis breweries including Anheuser-Busch, Lemp, and Falstaff for storing their product before the advent of refrigeration.

Early Maps

St. Louis was founded as a trading post by Europeans in 1763 (Kavanaugh, 2017, p. 27). Due to its favorable location the outpost quickly grew into a city. A number of maps show the early city (Figs. 2–3). Notably, they show how urban expansion overran the mounds in just a few years. In the Figure 2a map from 1790 two mounds are shown near the bastion at the northwest corner of the city. (Interestingly the Mississippi River is shown flowing from south to north.) As indicated by Figures 3(c) and 3(d), by 1846 the mound group was completely engulfed. The 1837 Lee and Meigs map (Fig. 3b) and 1846 Hutawa map (Fig. 3c) are of special interest as they show the locations for Peale mound number 9 and where the city water reservoir was located, which was on Peale mound number 19. The 1837 map (Fig. 3b) also shows the Big Mound.

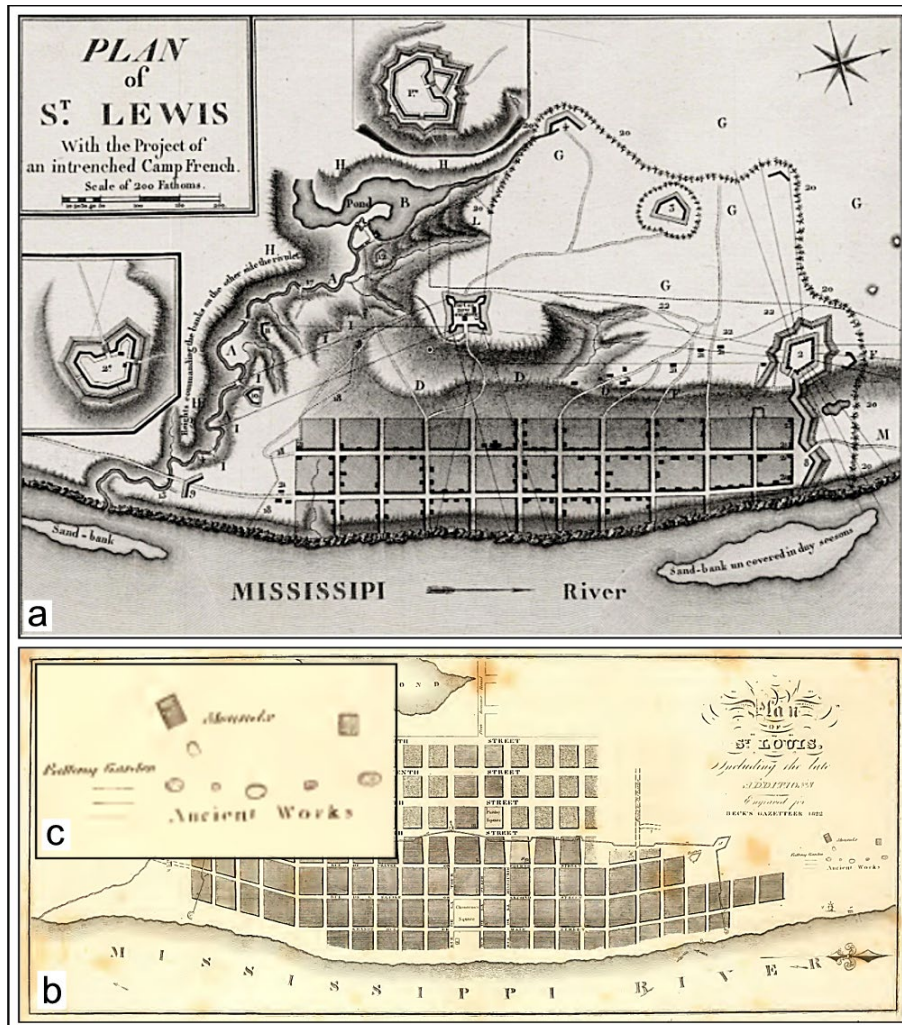

Figure 2a. Map of St. Louis made in 1796 by General Victor Collot. The map shows fortification plans drawn-up for the Spanish governor at the time. The fortifications were not completed (Reprinted from Skillman, 1846).

Figure 2b. Map of St. Louis made in 1822 (Beck, 1823, facing page 326).

Figure 2c. Enlarged detail showing St. Louis Mound Group (from Beck, 1823).

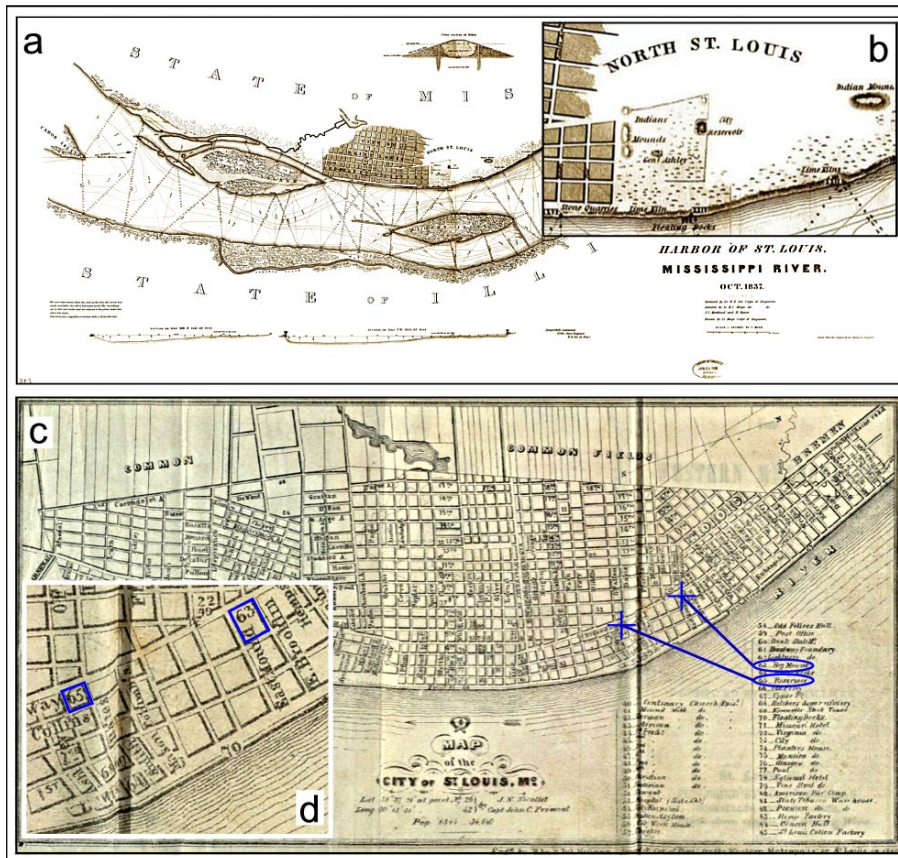

Figure 3a. Map made in 1837 by Lt. Robert E. Lee and Lt. M. C. Meigs, U.S. Army Corps of Engineers (State Historical Society of Missouri, Digital Collections, n.d.).

Figure 3b. Enlarged detail of Lee and Meigs 1837 map showing the reservoir on mound 19 and Gen. Ashley's house on mound 9 (mound numbers following Peale, 1862, p. 387).

Figure 3c. Map made in 1846 by Edward and Julius Hutawa; annotations in blue showing locations for reservoir mound 19 and Big Mound keyed to the legend (University of Missouri St. Louis Digital Library, n.d.; annotations by author).

Figure 3d. Enlarged detail (from Hutawa, 1846; annotations in blue by author).

The Peale and Say Map

The earliest known map showing all the mounds of the St. Louis Mound Group was made in 1819 by Titian R. Peale and Thomas Say (Fig. 4). The mounds vary in size and shape. Mound 27 was the largest at ca. 319 feet (97.2 m) by 158 feet (48.2 m) at its base and 34 feet (10.4 m) in height (Peale, 1862, p. 391). Its base was oval shaped. Other mounds were square, rectangular, or conical. A long line of mounds appears oriented north-south, while another group forms a circle around an elevated area resembling a plaza. (Features 1 and 2 on the map appear to be remnants of colonial era fortifications – see Figure 2a.) As suggested earlier, these patterns led to the hypothesis that the mound group was astronomically oriented.

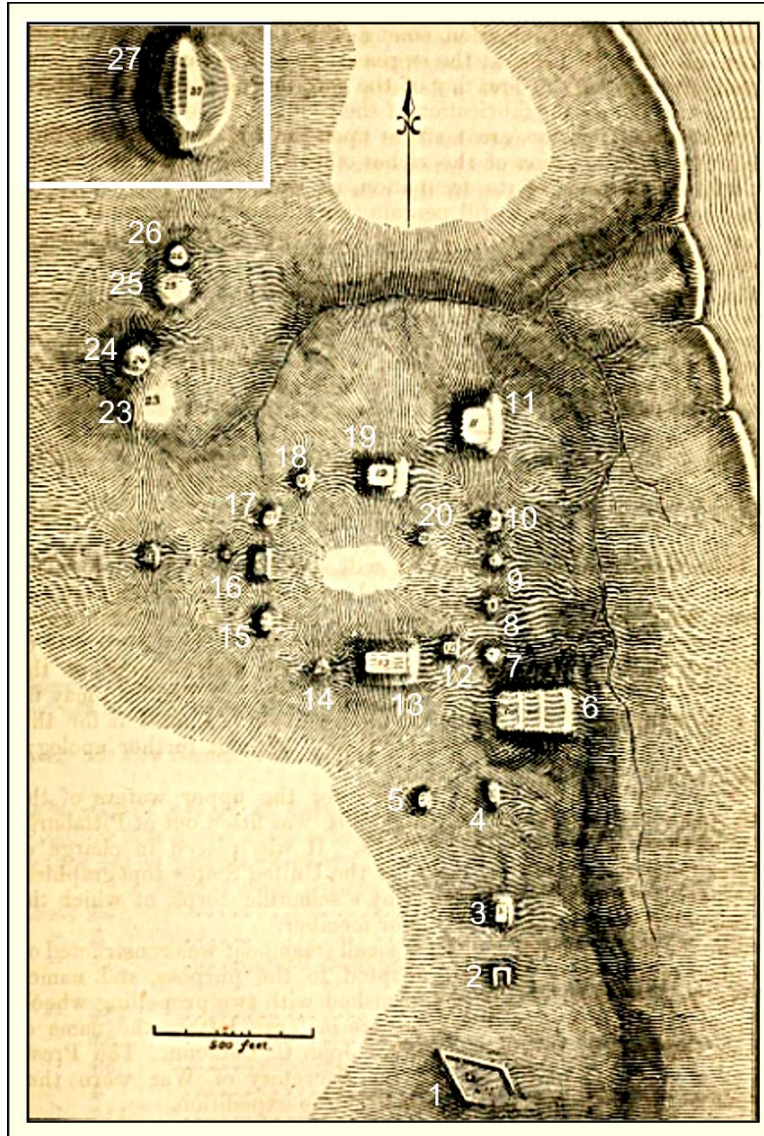

Figure 4. Map of St. Louis Mound Group made in 1819 (Peale, 1862, p. 387, mound numbers in white with inset border around mound 27 by author).

When the survey was made Peale was a naturalist and accomplished artist. He later went on to become Chief Examiner for the United States Patent Office (Peale, 1862, p. 386). Thomas Say was an entomologist, zoologist and founder of the Academy of Natural Sciences in Philadelphia. In 1819, Peale and Say were members of an expedition led by Major Stephen H. Long of the Army Topographic Engineers. As ordered by the Secretary of War, the expedition was intended “to explore the Mississippi, Missouri and their navigable tributaries, on board the United States steamboat *Western Engineer*....The prime objective of the expedition being a topographical description of the country to be explored...” (Say in James, 1823 [1], pp. 1–2). In June of 1819 the steamboat stopped at St. Louis to effect repairs (Peale, 1862, 387). It was during that stop that Peale and Say made their survey.

Mound measurements were initially reported by Say (in James, 1823, pp. 59–62) and again later by Peale (1862, pp. 389–391). Say (in James, 1823, pp. 59) explains that “The statement given below of their forms, magnitudes, and relative positions is the result of actual admeasurement taken with care, and with as much accuracy as their present indefinite boundaries, together with the dense growth of underwood, covering their surface and tending to beguile and obstruct the vision of the observer will admit.” Peale (1862, p. 388) adds that measurements were made using a “pocket compass and tape measure”. Mound dimensions recorded by Say and Peale are included herein as Appendix 1.

The Peale and Say map was not published immediately. Indeed it might have been lost forever except that as explained by Peale, decades after the expedition he discovered the map in an “old portfolio.” Recognizing its potential value, Peale submitted the map with an accompanying article to the Smithsonian Institution. Forty-three years after it was drawn, the map was published by the Smithsonian in their Annual Report for 1862 (Peale, 1862, p. 386).

Comparison of the Peale and Say map to later survey data (see below) finds that their north arrow is oriented to true north. Distances are more problematic as a result of how measurements were made. According to Say (in James, 1823, p. 59), “What we have called *base* in the following statement is in reality the length of a line passing over the top of the mound from the termination of the base each side.” Additionally, measurements were hampered by dense underbrush as commented on by Say (in James, 1823, p. 59).

In any case, the significance of the Peale and Say map is that it shows the mound group before destruction. More precise assessments are enabled by consideration of the survey plats shown in Figures 5–7.

Figure 5 is a survey plat that accompanied a February 1852 Surveyor General’s report for the States of Illinois and Missouri, to the Commission of the General Land Office. (At the time under the purview of the U.S. Department of Interior.) The Surveyor General for Illinois and Missouri was M. Lewis Clark, Sr. Clark was a graduate of West Point and served as an officer and map maker during the Black Hawk War. After leaving the Army Clark worked as an architect-designer and in 1836 was elected to the Missouri General Assembly. In 1840 he was appointed city engineer for St. Louis. After a brief return to military service, Clark returned to St. Louis where in 1849 he was appointed Federal Surveyor General for Illinois and Missouri – a position he held until 1853 (Winter, 1999, p. 188). Clark was most likely the surveyor for the 1852 plat presented below.

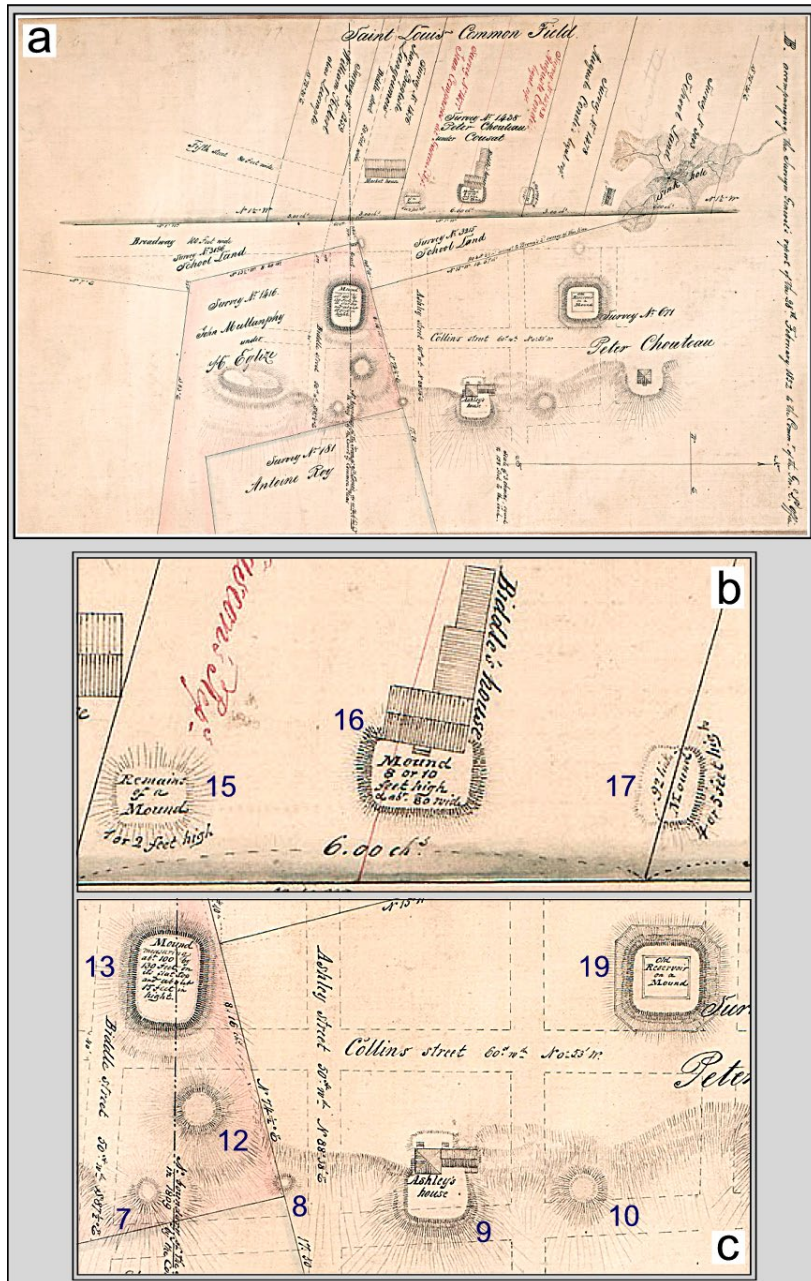

Figure 5a. Survey plat from 1852 (Missouri Department of Agriculture Land Survey Index, n.d.).
 Figure 5b. Enlarged detail of 1852 plat. Original notes on plat for mound 15: “Remains of a Mound 1 or 2 feet high,” for mound 16: “Mound 8 or 10 feet high about 80 wide,” for mound 17: “Mound 4 or 5 feet high” (Mound numbers following Peale, 1862 added by author).
 Figure 5c. Enlarged detail of 1852 plat; original notes on plat for mound 13: “Mound measuring about 100 by 130 feet on its flat top and about 15 feet in high [sic]”, for mound 9: “Ashley’s house,” for mound 19: Old Reservoir on a Mound” (Missouri Department of Agriculture Land Survey Index n.d., mound numbers following Peale 1862 added by author).

With regard to the surveyor’s notes on the 1852 plat it is interesting that for mound 13, the dimensions are given as about 100 feet (30.5 m) by 130 feet (39.6 m), with

height as 15 feet (4.6 m). Peale (1862, p. 390) gives the dimensions for the top surface of the mound as 97 feet (29.6 m) by 134 feet (40.8 m), with a height of 12 feet (3.6 m).

The 1852 plat is remarkably detailed and as I will demonstrate below, accurate. No doubt this is due to rigorous standards for land surveying codified into law (see e.g., United States General Land Office, 1855, *Instructions to the Surveyors General of Public Lands*). For example, Surveyors General manuals during the mid-1800s provided surveyors with instructions as to how to determine true north by Polaris sightings but strongly prescribed use of Burt's solar compass (Figure 6). Burt's solar compass used the time of day, latitude and tables of solar declination to establish azimuths relative to true north. The vertical and horizontal circles on the instrument were graduated to 30 minutes of arc. By using verniers on the instrument, accuracy to within a single minute of arc could be achieved (National Museum of American History, 2023). Patented in 1836, the instrument proved so useful and so accurate that it was eventually used to survey most of the public lands in the West (White, 1984, p. 114). Given that azimuths on the plats shown in Figure 5 are quoted to minutes of arc, there is little doubt that Burt's solar compass was used for the St. Louis surveys.

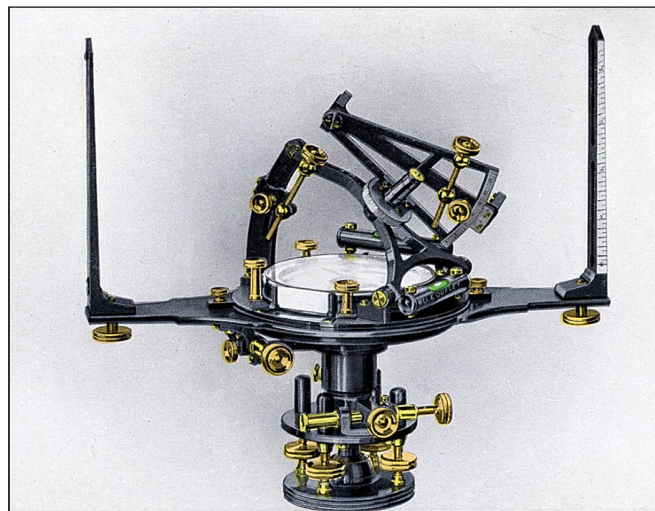

Figure 6. Burt's solar compass 1910 version manufactured by W. & L. E. Gurley (Gurley, 1910, p. 210).

Details such as mounds are recorded on the 1852 plat and often times other plats because Surveyors General instructions specifically required that the surveyor record features to include: "*Natural curiosities*, interesting fossils, petrifications, organic remains, &c.; also all ancient works of art, such as mounds, fortifications, embankments, ditches, or objects of like nature" (United States General Land Office, 1855, p. 18).

Toward assessing the mound group for alignments using the 1852 plat, the azimuths of city streets shown on that plat were compared to the same streets represented on a

basemap provided by ArcGIS Online (Esri, 2023). (The names of several streets have changed over the years, but azimuths for relevant streets remain the same.) This not only allowed assessment of the 1852 plat but also enabled the plotting of mounds on the ArcGIS basemap as well as Google Earth Pro satellite imagery. With reference to Figure 7a, a series of red dashed lines were drawn on the 1852 plat by the present author along the edges of several streets, simulating in effect a closed traverse survey. The plotted red dashed lines were then copied and superimposed onto the Figure 7b ArcGIS basemap. As shown, the red dashed lines on both figures closely match in terms of angle and length. Also helpful is that on the 1852 plat the azimuth for Ashley Street is given as N 88° 33' E (Fig. 7c). Measurement of Ashley Street on the ArcGIS basemap matches that. (Note the procedure just outlined is not the same as georeferencing — which in this case would not have been especially useful.) The matching Ashley Street azimuths is quite remarkable given that in the 1800s city streets in the area were not paved as they are now. Surveyed azimuths undoubtedly incorporated some wiggle-room.

Having confirmed that the city streets represented on the 1852 survey plat and the modern basemap are, for all practical purposes the same, the outlines for mounds 9, 13, and 9 on the plat were traced, copied as a group to maintain relational integrity and superimposed on the ArcGIS map (Fig. 7b). As discussed later, the locations for these particular mounds was also fact-checked using historic records. By this method the locations for mounds 19, 13, and 9 relative to the city's present-day streets is established with a high level of confidence. The matching azimuths for the 1852 plat north arrow, Peale map and ArcGIS true north arrow confirm that the 1852 plat and the Peale map were oriented to true north.

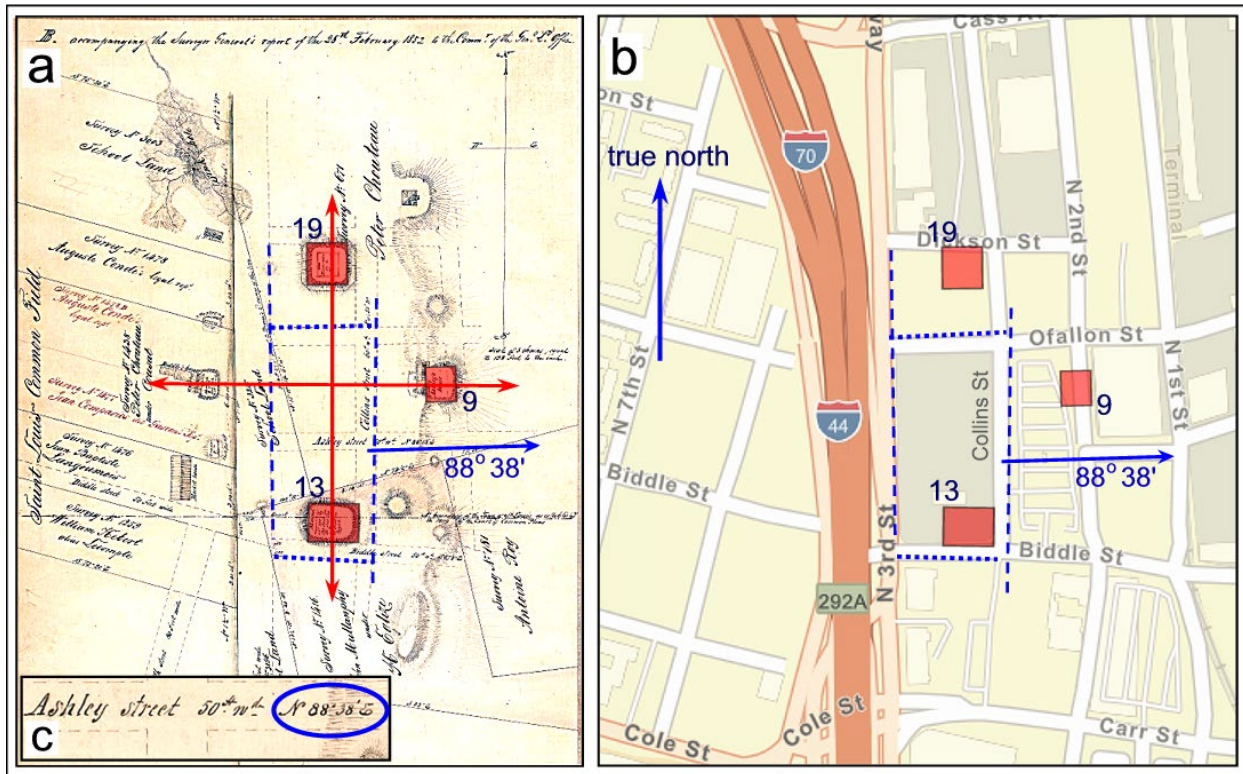

Figure 7a. 1852 survey plat showing core area of St. Louis Mound Group with red boxes outlining mounds 19, 9 and 13, dashed blue lines following street directions, red lines showing cardinal directions, blue arrow showing azimuth for Ashley Street. (Missouri Department of Agriculture Land Survey index, n.d., annotations by author).

Figure 7b. Modern-day ArcGIS base map with blue lines and mound representations copied from Figure 7a and superimposed on ArcGIS map (Esri, 2023, annotations by author).

Figure 7c. Enlarged detail from 1852 plat showing azimuth for Ashley Street as recorded by original surveyor (Missouri Department of Agriculture Land Survey Index, n.d.).

Based on the above, Figure 8 shows my estimate for where the core mound group was located relative to the current situation. As the Google Earth Pro image shows, although the area on the west is severely impacted by Interstate 44, there are other areas where sub-mound features might still be found below ground level, especially in unpaved areas.

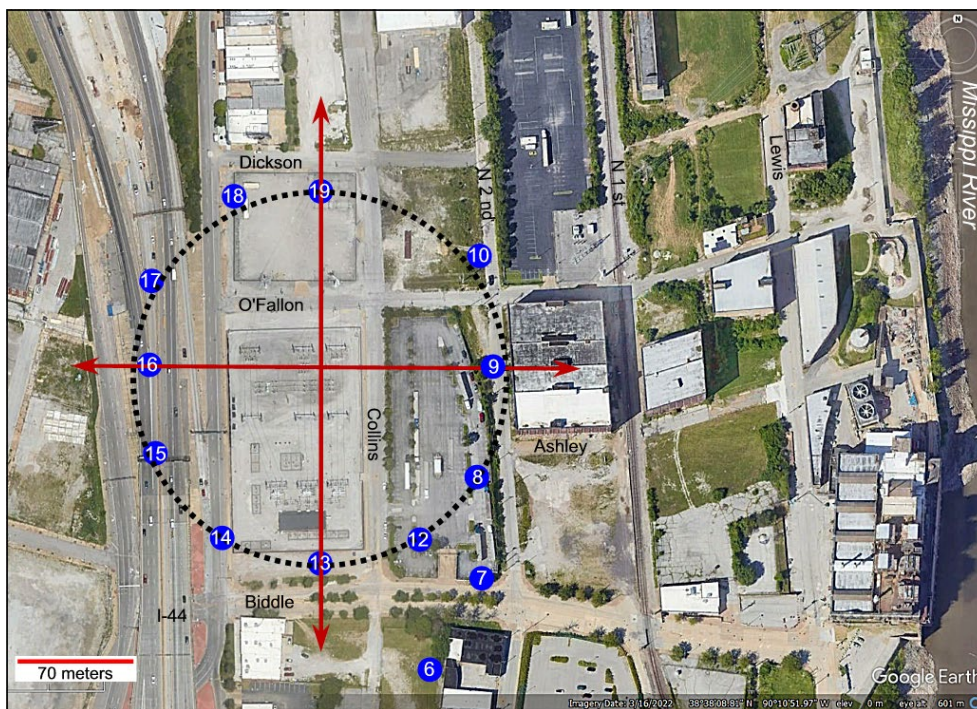

Figure 8. Google Earth Pro image annotated by the author to show likely locations for the core St. Louis Mound Group. Blue circles show center of mounds. Numbering follows Peale, 1862. Eye altitude 601 m, image date March 16, 2022 (Google Earth Pro, n.d.).

Confirmation that several of the mounds are (or were) at the locations noted above is provided by the lithograph shown in Figure 9. This figure is one of 110 plates each showing a section of St. Louis drawn in 1874, in three-dimensional perspective (Dry, 1876). Drawings were made by commissioned artist Camille N. Dry. Richard J. Compton was a lithographer in St. Louis and owned the company that published the volume.

Notably, the Figure 9 drawing includes street names and shows what remained of mounds 19, 13, 12 and 9. In the key that accompanies the drawing, feature number 18 is identified as “Mansion House of Gov. Ashley”. Knowing from earlier mentioned documents that the governor’s house was built on a mound, the lithograph allows us to identify the location for Peale mound number 9. Similarly, feature number 21 on the lithograph is identified in the key as “Site of Reservoir, first St. Louis waterworks”. Historic records (e.g., Hoffman, 1835, vol. 2, p. 75) indicate that this was the location for mound number 19 on the Peale map. Also as indicated by the yellow line that I have drawn on the lithograph, the sightline between mounds 19 and 13 extends parallel to Collins Street.

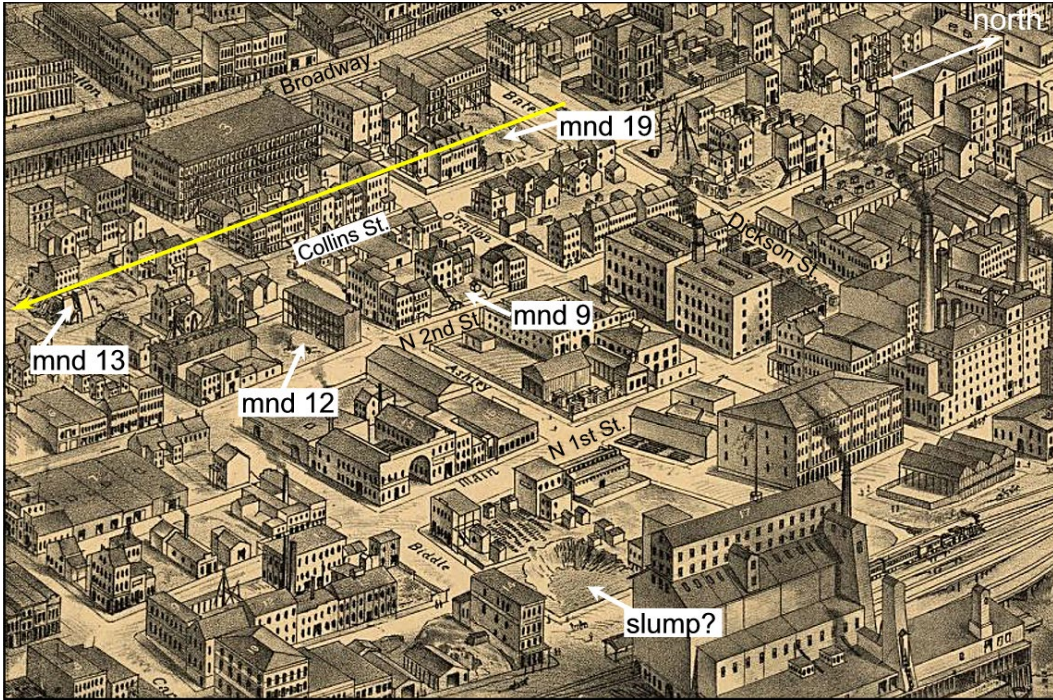

Figure 9. Dry (1876, Plate 19) showing area of north St. Louis. Big Mound is located further north. (The Library of Congress, Geography and Map Division, n.d.; annotations by author).

By comparing the Dry lithograph to the ArcGIS map it is confirmed that although there have been changes to certain streets (including name changes in a couple of instances), the overall street layout has remained sufficiently unchanged as to allow the locations for mounds 19, 13, 12 and 9 to be located relative to modern-day streets.

An intriguing question is how Compton and Dry accomplished their perspective views. Here is their explanation (Compton in Dry, 1876, preface, no page number):

The preliminary drawings for this work were made early in the spring of 1874. After a careful consideration of the subject, it was determined to locate the point of view so that the city would be seen from the southeast....Accordingly, the point of site was established on the Illinois side of the river, looking to the northwest, and at sufficient altitude to overlook the roofs of ordinary houses into the streets.

A careful perspective, which required a surface of three hundred square feet, was then erected from a correct survey of the city, extending northward from Arsenal Island to the Water Works, a distance of about ten miles, on the river front; and from the Insane Asylum on the southwest to the Cemeteries on the northwest.

Every foot of the vast territory within these limits has been carefully examined and topographically drawn in perspective, by Mr. C. N. Dry

and his assistants, and the faithfulness and accuracy with which this work has been done an examination of the pages will attest.

Big Mound

Two mounds in the St. Louis Mound Group have received particular attention over the years — the Big Mound and the Falling Garden Mound.

Big Mound is mound number 27 on the Peale and Say map (Fig. 4). For that figure I added an inset box around the mound to clarify that, as Peale (1862, p. 391) explains and as noted earlier, the mound was actually located further north and would not have fit on the map if represented at the correct distance.

Although completely obliterated, the original location for the Big Mound can be plotted with good accuracy. The Hutawa map places the Big Mound in the block bounded by Broadway on the west and East Brooklyn and East Mound streets on the north and south, respectively (Figs. 3c and 3d). The Dry (1876, Plate 45) lithograph (Fig. 10 below) shows the area in 1874 and appears to show remnants of the Big Mound.

Several locations on the Plate 45 Dry lithograph (Fig. 10) are numbered and cross-referenced to a key that accompanies the lithograph - namely, Fire Company No. 9, the Mound Market building, and the Gestring & Becker carriage factory. The locations of these features can be used to assess the accuracy of the watercolor painting in Figure 11. The Figure 11 watercolor was made by artist Mat Hastings (1834–1919). The painting shows the Mound Pavilion fire of 1848. Built on top of the Big Mound in 1844, the pavilion, or “pleasure resort” was 80 feet (24.4 m) in length and two stories high [width not given] (Green, 1844, p. xix). To better fit the pavilion on the narrow summit of the mound, the mound was truncated by about 2 feet (0.6 m) (Smith, 1869, p. 4).

Importantly, the watercolor shows the Big Mound relative to the features identified in the Plate 45 Dry lithograph. Presuming that the Dry lithograph and Hastings watercolor are relatively accurate, the location for the Big Mound can be established. Noteworthy is that the watercolor shows Mound Street cutting through the mound, with a two-story house on top of the southern remnant of the mound. This comports with reports that mound destruction occurred over several years beginning sometime in the 1840s rather than all at once in 1869. Smith (1869, p. 2) reports seeing the mound as early as 1843 at which time he says it was in a “perfect state, with the exception of changes incident to time and weather.” Smith (1869, p. 2) also comments, however, that both the south and north ends of the mound had been cut through for streets before final leveling.

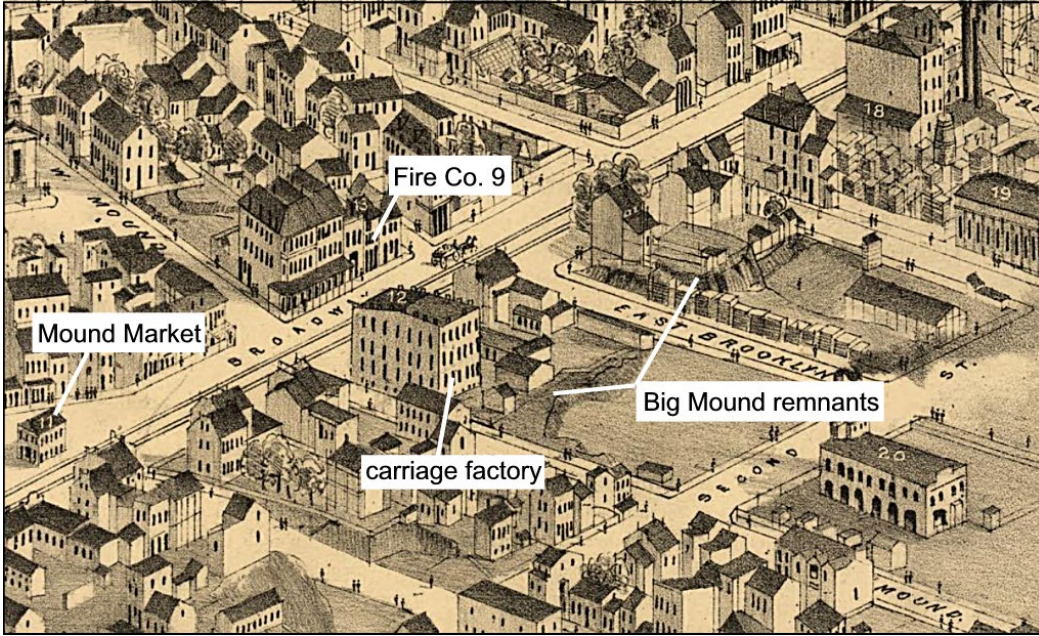

Figure 10. Enlarged detail from (Dry, 1876, Plate 45). View is looking from the southeast. Accompanying key identifies feature 12 as “Carriage Factory, Gestring & Becker Props,” feature 9 as “Mound Fire Company No. 9” and feature 11 as “Mound Market.” (The Library of Congress, Geography and Map Division, n.d., annotations by author).



Figure 11. 19th century lithograph by artist Mat Hastings showing Mound Pavilion fire of 1848. View is looking southeast from near Mound Fire Company No. 9 along Broadway. Mound Market building is visible at far end of Broadway (Alamy stock photo, licensed use).

Based on the above, Figure 12 shows my estimate for where the Big Mound was. Oval-shaped at its base, Peale (1862, p. 391) gave its base dimensions as 319 feet (97.2 m) by 158 feet (48.2 m) and 34 feet (10.4 m) in height, with its top surface measuring 136 feet (41.5 m) in length by 11 feet (3.4 m) in width. Dimensions shown on survey plats differ from Peale — perhaps due to the difficulty in determining the edges of the mound relative to the bluff it was situated on; or maybe because the base outline of the mound was slowly being encroached upon by city streets. The Hastings watercolor indicates that the boundary between the mound and Broadway was not well-delineated by curbs or pavement. ArcGIS measurement finds that the north-south distance between East Mound and East Brooklyn streets adjacent to Broadway is 268 feet (81.7 m). Accordingly, if Big Mound was 319 feet (97.2 m) in length, then the mound would have extended past the distance between the two streets. This agrees with what Smith (1869, p. 2) reported and the Hastings watercolor. In any case, the summit was not flat-topped, but rather, slightly rounded (Williams and Goggin 1956, p. 12).

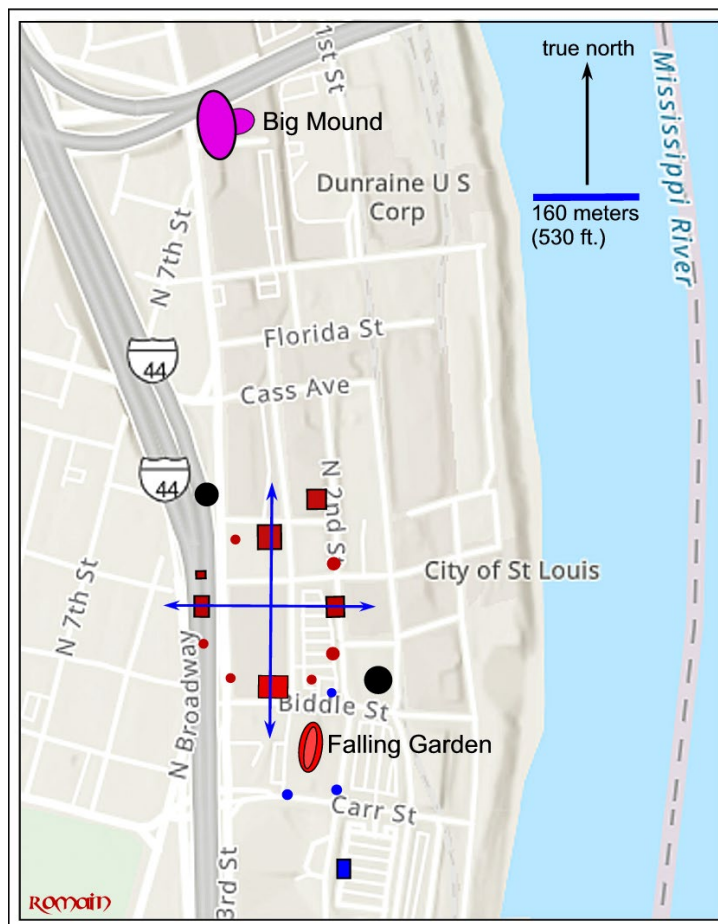

Figure 12. ArcGIS basemap with St. Louis Mound Group. Locations, shapes and size for red mounds based on 1852 survey plat. Location, shape and size of Big Mound in pink based on

sources in main text and 1847 plat. Locations for mounds in blue after Peale and Say map. Blue lines show cardinal directions. Black-filled circles shows location for mound 18 cave and Biddle Street slump (Esri, 2023; The State Historical Society of Missouri, n.d.; Peale, 1862; plotted by author).

Peale documents the existence of a terrace – 79 feet (24.1 m) in length, extending from the east side of the Big Mound. Similar low platforms attached to large mounds are sometimes found at other Mississippian sites (e.g., Monks Mound at Cahokia, Mound A at Angel (see Romain, 2021a; Romain & Herrmann, 2022)). Figure 13a shows an enlarged detail of Peale’s representation of the Big Mound with its lower platform or terrace. Figure 13b shows an enlarged detail from a survey plat signed “Charles De Ward, Engineer and Surveyor”. No date or north arrow appear on the plat. However, Charles De Ward was the county surveyor from 1831 to 1841. If drawn when De Ward was county surveyor, then this is one of the earliest known surveys of the Big Mound.

To orient the De Ward plat, I drew a red line on the plat along the edge of Mound Street. The plat was then rotated so the azimuth of the red line on the plat matched a corresponding red line drawn on the Figure 13c ArcGIS basemap.

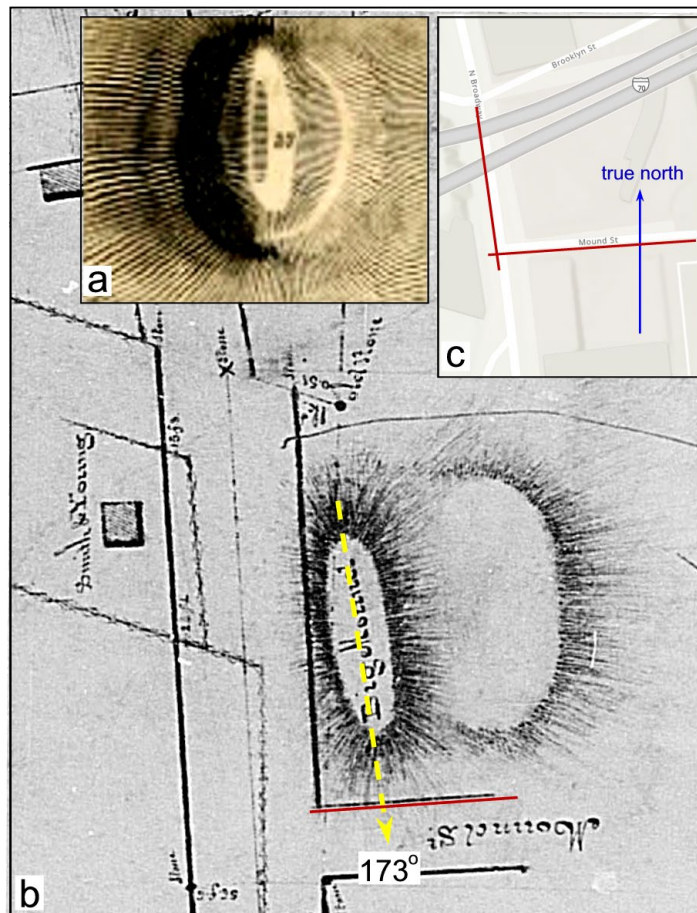

Figure 13a. Enlarged detail from map showing Big Mound with terrace on east side (Peale, 1862, p. 387).

Figure 13b. Enlarged detail from De Ward survey plat showing terrace on east side of Big Mound; yellow dashed line showing Big Mound longitudinal azimuth as 173° . (Missouri Department of Agriculture Land Survey Index, n.d.; annotation by author).

Figure 13c. ArcGIS basemap with red line drawn along Mound Street by present author used to orient Figure 13b survey plat (Esri, 2023).

The orientation of the Big Mound is of interest. As Figures 13b and 14a–14e show, five independent ground surveys made when the mound still existed indicate that the longitudinal axis of the mound was 173° (T). This is different from what the Peale map shows. Peale shows the mound oriented to north (Fig. 13a). As discussed earlier, the Big Mound inset was added to the original Peale map. Interestingly, the magnetic declination for the area in 1819 was $7^\circ 47'$ E (NOAA, 2023). Accordingly, it appears that somewhere in the map-making process, the added mound 27 was mistakenly aligned to magnetic north.

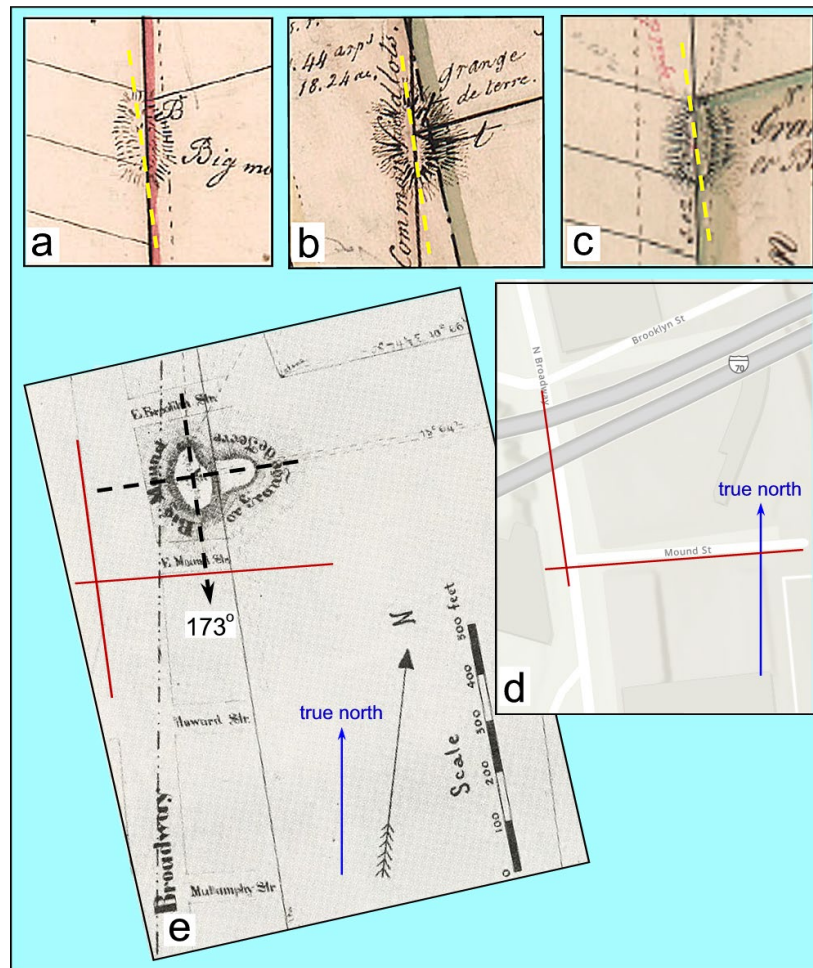

Figure 14a. Detail from May 1846 survey plat signed “F. R. Conway, Surveyor of the Public Lands in the States of Illinois & Missouri” (Missouri Agriculture Land Survey Index, Y9903878, n.d.).

Figure 14b. Detail from June 1847 report to Surveyor General for Illinois and Missouri (Missouri Agriculture Land Survey Index, Y9903880, n.d.).

Figure 14c. Detail from June 1847 report to Surveyor General for Illinois and Missouri (Missouri Agriculture Land Survey Index, Y9903881, n.d.).

Figure 14d. ArcGIS map with red lines drawn along street edges by author for orienting map in Figure 14e (Esri, 2023).

Figure 14e. Detail from 1855 survey plat by Nathaniel F. Hyer, County Surveyor. Plat rotated by author to match ArcGIS azimuths along edges of Market and Mound streets. Note corresponding red lines on Figures 14d and 14e. Black dashed lines added by author showing major and minor axes of Big Mound (Missouri Historical Society, n.d.-a).

Figures 15 and 16 show two different views of the Big Mound. What is remarkable about the Figure 15 image is that it gives a sense of how large the Big Mound was. It easily dwarfed the steamboats in the foreground. For comparative purposes the Big Mound was about equal in length to an American football field.



Figure 15. Color engraving of 1852 lithograph made by John W. Hill. View is from Illinois side of Mississippi River, looking west. Big Mound is at far right (Missouri History Museum, n.d.-b).

Figure 16 shows the Big Mound in the final stages of being leveled. Again, what is notable is the impressive size of the mound as evidenced by the two people near its summit.

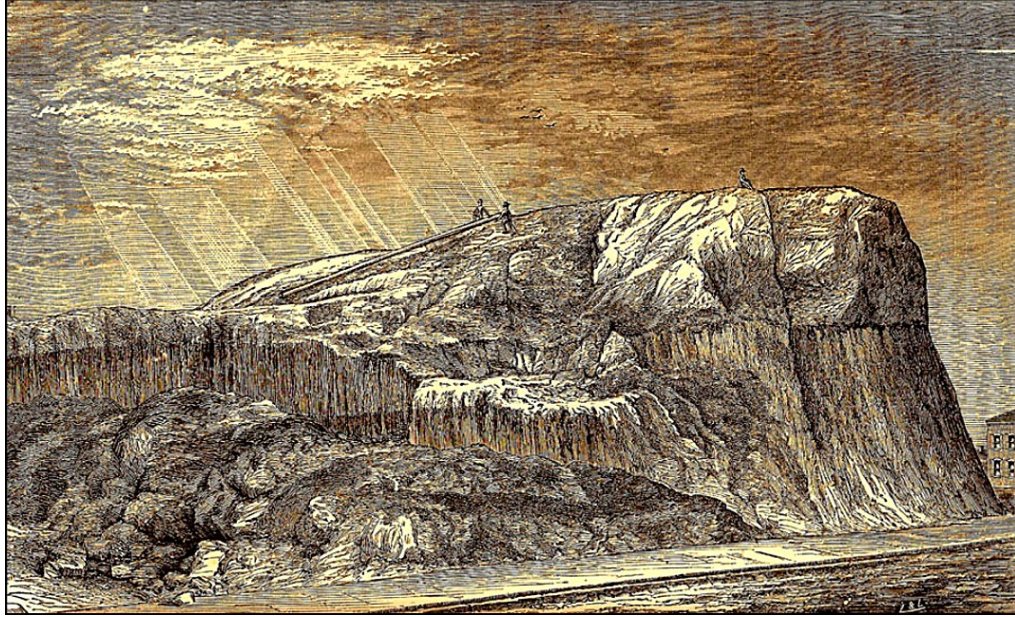

Figure 16. Drawing of the Big Mound during the process of being leveled (Conant, 1869, frontispiece).

The most detailed account of what was found in the Big Mound during its leveling is provided by Alban J. Conant (1879, pp. 42–45). According to Conant, a large “sepulchral chamber” was found in the mound. This chamber was “eight to twelve feet wide, seventy-five feet long, and from eight to ten feet in height” (Conant, 1879, p. 45). The chamber contained between twenty to thirty burials. Further, “the bodies had all been placed in a direct line, upon the floor of the vault, a few feet apart, and equidistant from each other with their feet towards the west” (Conant, 1879, p. 430). A large quantity of beads and drilled shells accompanied the burials. Also found accompanying one of the burials were two, copper “long-nose” maskettes, each about 3 inches (7.6 cm) in height by 1 ½ inches (3.8 cm) wide (Richards, 1870, p. 63; Williams and Goggin, 1956, Table 1). Similar maskettes have been found at a number of Mississippian Period sites (Duncan & Diaz-Granados, 2000). The maskettes are good indicators that the Big Mound was built by Mississippian-era people. (In fact, given the spatial relationships discussed later between the Big Mound and core group it seems likely that the entire mound group was built by Mississippian people.) The positioning of individual bodies with feet toward the west as noted by Conant was perhaps intended to metaphorically correspond to the movement of the sun rising in the east at the beginning of life and setting in the west at the end.

Worth noting for the possibility of sub-mound burials are the observations of Nathaniel Holmes (Missouri Supreme Court judge). In a September 20, 1870 letter from Holmes to Professor Wyman at the Peabody Museum at Harvard University, Holmes (quoted in Williams and Goggin, 1952, p. 63) states the following:

I present to you...some Indian remains consisting of a fragment of a jaw-bone and teeth, a lock of hair...from John F. Madison, Esq. of St. Louis....They were taken from graves found at the base of the Big Mound at St. Louis in 1869 when the central portion of the mound was excavated away to the bottom to furnish materials for an extension of the road-bed of the North Missouri Railroad. *The graves appear to have been dug first, in the natural surface of the hill, or bluff on which the mound stood....*[Emphasis added by present author.] The graves extended over an area seventy feet [21.3 m] in length and 20 feet [6.1 m] in width, under the central part of the mound. Above these, and in the artificial portion, came another series of graves and over the whole the mound of earth was finally raised to the height of 35 [10.7 m] to 40 feet [12.2 m]. Mr. Madison obtains his facts partly from his own observations and in part from the statements of the workmen and other persons in the vicinity.

The feature described by Holmes as seventy feet (21.3 m) by twenty feet (6.1 m) corresponds to Conant's description of the "sepulchral chamber." What is interesting, however, is Holmes' opinion that the burial chamber appeared to have been dug into the hill — implying that it was a sub-mound grave. If such was the case, that would have important implications for any future development in the area that extends below the planar surface of the levelled mounds. Indeed, in 2009, as part of their reconnaissance survey prior to construction of the Stan Musial bridge, the Missouri Department of Transportation excavated at the corner of Broadway and Brooklyn. Reportedly, a "handful of prehistoric artifacts" were found (John Marshall quoted in Pryor, 2011).

Of interest is that "caves" were supposedly located in the Big Mound. The caves "were entered by a short, narrow tunnel"; "the largest room was about twenty feet [6.1 m] square and seven feet [2.1 m] high" (Rother and Rother, 1996, p. 123). According to an account in *The Missouri Republican: St. Louis* newspaper (December 9, 1877, p. 11) truant boys evaded police using these caves. It is not clear if the supposed caves were natural or not; and if natural, whether or not they extended below the base of the mound (which appears to have been situated on a small rise on the bluff). A statement made in 1945 by Frank R. Fisher (Rogers and Pulcher 1987, p. 6) alleges that the caves resulted from excavations made by early settlers for the procurement of sand. Alternatively, the "caves" could have been burial chambers that were burrowed into. Rother and Rother (1996, p. 123) refer to the features as "caves". If there was in fact a cave in or under the mound that would have intriguing cosmological implications — such as the juxtapositioning of burials at a gateway entrance to the Below World.

In any event, burials were also reportedly found during the construction of General Ashley's residence built on Peale mound number 9. As reported by Flagg (1838, p. 126 [154]): "In excavating the earth of this mound, large quantities of human remains, pottery, half-burned wood, etc., etc., were thrown up."

Falling Garden Mound

The Falling Garden Mound is mound number 6 on the Peale map (Figure 4); and is shown on the 1852 survey plat (Figures 7a and 17). Peale (1862, p. 389) gives the following description:

[the mound] consists of three stages, all of equal length and of the same parallelogramic form. The superior stage, like the five succeeding mounds, is bounded on the east by the edge of the second bank of the river. The second and third stages are in succession on the declivity of the bank, each being horizontal, and are connected with each other, and with the first, by an abruptly-oblique descent.

Unfortunately, there is no record of what, if anything, was found in the mound when levelled in the 1800s. Representations of the mound made by Peale and the 1852 survey plat differ. The Peale map shows the mound as a rectangular sort of structure; the 1852 survey shows it as an oval. Given how accurate other aspects of the 1852 plat are, I am inclined to believe that the 1852 plat correctly represents the mound. That both figures show the same mound is indicated by the fact that although the base mound outlines are different on the two figures, the Peale map and 1852 plat agree with reference to the length of the uppermost mound. Peale (1862, p. 389) gives its length as 88 feet (26.8 m). Using the width of Biddle Street on the 1852 plat as a comparative guide, the length of the upper platform on the plat is about 90 feet (27.4 m).

The features that Peale refers to as “declivities” are scarps and in the 1852 plat they are shown by a series of hachures. They define the edges of the river terraces. As the mound was situated within a few feet from the edge of the second terrace, the view from the river gave the appearance of a series of platform steps leading to the mound at the top — hence the name, Falling Garden.

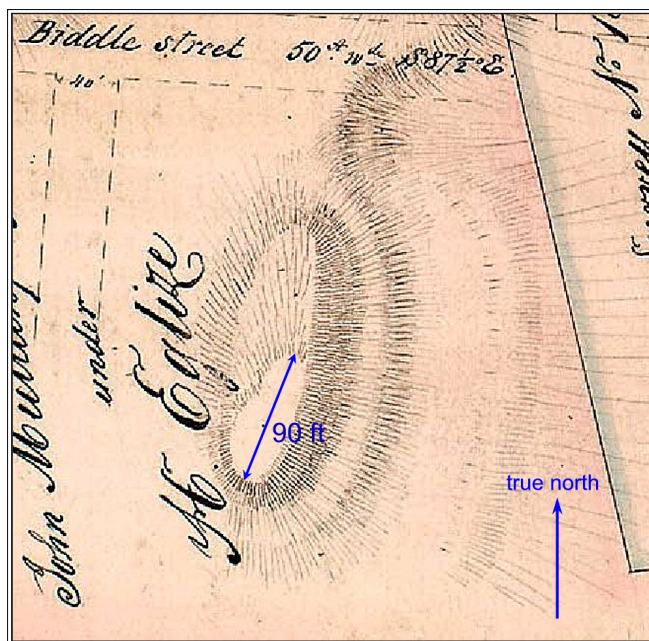

Figure 17. Detail from 1852 survey plat showing Falling Garden Mound (Missouri Department of Agriculture Land Survey Index, Y9903892, n.d.; annotations in blue by author).

Archaeoastronomic Assessments

In the preceding pages substantial effort was devoted to identifying the location for the St. Louis Mound Group; and although the Peale map led to the initial hypothesis that the mound group might be intentionally oriented, actual analyses relied on the more accurate survey plats. These analyses revealed a combination of celestial and landscape alignments. Astronomic alignments include a north-south linear arrangement of several mounds, an orientation within the circular core group to the cardinal directions and solstices, and orientation of the Big Mound to the Milky Way. Detailed discussions follow. However, a couple of introductory comments may help explain the significance of what we see in the archaeological record.

Cardinal and solstice directions were of considerable importance to Native American peoples. Structures of all kinds were often aligned to cardinal and/or solstice directions. Seasons, colors, entities, phases of life, and forces (both visible and not visible) were often associated with the different directions. So too, ceremonies, feasts, and celebrations were often timed relative to the solstices as these events provided a designated time for the gathering of people and marked the change of seasons. A dramatic photograph showing a summer solstice alignment between mounds at the Mississippian-era Angel site can be seen in a recent article by Romain and Herrmann (2022, Figure 3). An example that demonstrates the significance of the cardinal directions for the Osage (Dhegiha Siouan language group) is provided by Native American anthropologist, Francis La Flesche (1995, p. 137):

When the tribe was at peace with all the world, the face of the symbolic man was always turned toward the east whence arises the sun, the great life symbol. As he thus stands, his left side is toward the north, the place of the Sky great division, representing the sky, and his right side toward the south, where is the Earth great division, representing the earth with its teeming life on land and in water. When the tribe goes forth to war...then the symbolic man...stands facing the west, the direction of the darkness of death.

In the case of the Pawnee (Caddoan language family), their earth lodges were oriented to the cardinal and intercardinal directions. The outer shape of the Pawnee lodge was circular, to represent the heavens, while interior support posts were situated at the intercardinal directions — thus orienting the structure through its major and minor axes to the cardinal directions (see e.g., Chamberlain 1981, Figure 22).

Cardinal Direction Alignments

Figure 18 shows my analysis of the 1852 survey plat. Two lines can be extended through several mounds along a north-south line. The first of these lines extends between mounds 19 and 13. A flanking north-south line is indicated by a line drawn through mounds 10, 9, 8, and 7. What gives this flanking line credibility is the location of mound 10, slightly offset from the design circle (dotted pink line). Mound 10 is offset just enough to establish the north end of the north-south line, while also still being one of the mounds comprising the mound circle. The intentionality of the flanking line is further suggested by the otherwise anomalous location for mound 7. And the north-south line may extend even further south. The survey plats do not cover the area south of mound 6, but on the Peale map, mounds 3 and 4 appear to have been part of this north-south line.

The most obvious cardinal alignments include the north-south line between mounds 19 and 13 and the orthogonal east-west line between mounds 9 and 16. Orthogonal relationships are good indicators of intentionality and where those orthogonal lines are precisely laid out to north-south and east-west, there can be no doubt that cardinality was the intended result. The relative importance of the north-south sightline is found in the observations that mounds 19 and 13 are the largest of the core group. The next largest mounds comprise the east-west sightline through mounds 9 and 16.

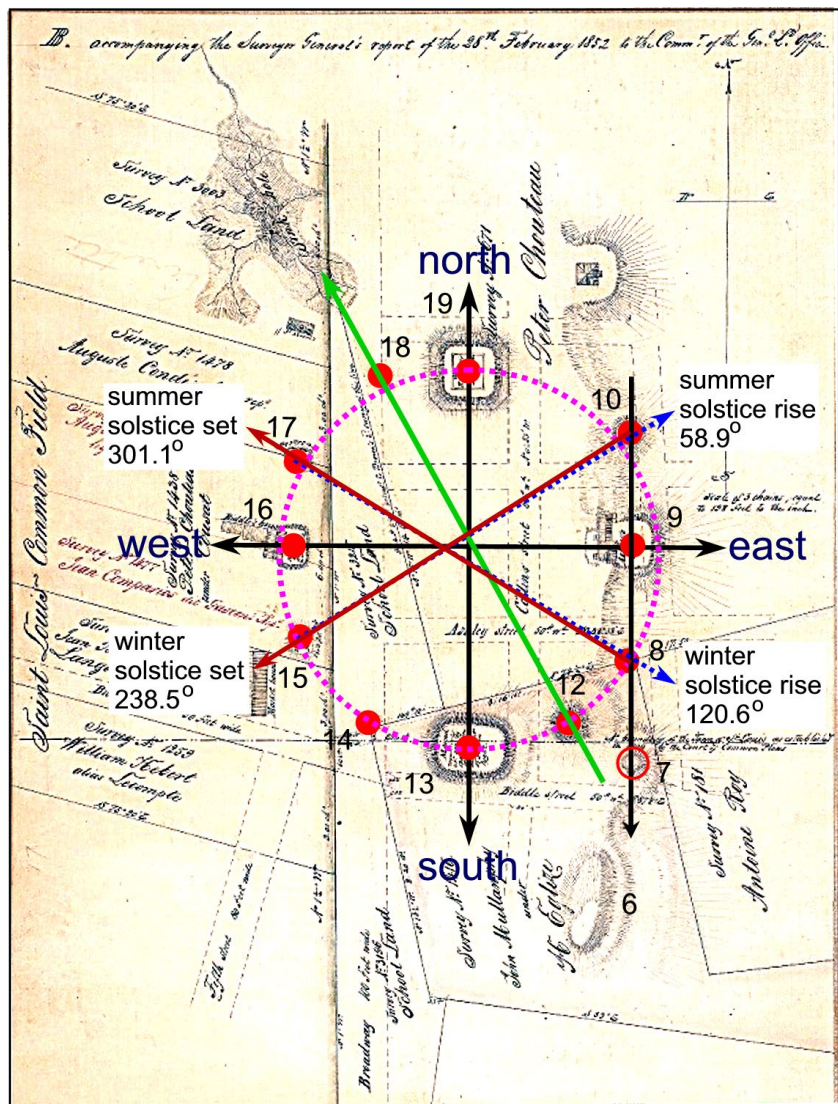

Figure 18. Survey plat from 1852 with cardinal directions, solstice azimuths, and sinkhole/cave. Pink dotted line shows circular layout of core group. Solid black lines show alignments to cardinal directions. Red solid and blue dotted lines show solstice alignments. Green line shows mound alignment to large sinkhole/cave (Missouri Department of Agriculture Land Survey Index document Y9903892, n.d.; Peale, 1862; plotted by author).

Solstice Alignments

Considered next are solstice alignments. Azimuths for solstice events were calculated according to the formula (McCormac, 1983, p. 345):

$$\cos A = (\sin \delta - \sin \varphi \sin h) / (\cos \varphi \cos h)$$

where, A stands for the azimuth, δ (delta) is the declination for the sun (for A.D. 1000), h is horizon altitude, and φ (phi) represents the latitude of the site. (For declination value

see Ruggles 2015b, Table 31.3.) In this formula, horizon altitude refers to the vertical angle of the distant horizon relative to a flat plane, measured in degrees.

Horizon altitude is a major factor in determining solstice azimuths. As the horizon altitude increases or decreases due to topography and vegetation cover, the apparent rising and setting azimuths for celestial bodies vary accordingly. In this case horizon altitudes were determined using the computer program, Horizon (Smith, 2012). Figures 19a and 19b show the respective east and west horizons plotted from the center of the mound group. Horizon altitude (h) values (before refraction corrections) were: summer solstice rise azimuth = 0.01° ; winter solstice rise azimuth = 0.11° ; winter solstice set azimuth = 0.9° ; summer solstice set azimuth = 0.4° . (The Horizon program does not plot solstice azimuths prior to 1800 — hence solstice positions are for year A.D. 2023. As a practical matter the difference in solstice azimuths between A.D. 1000 and A.D. 2023 is minimal and not discernable to the naked eye — implying that in this case the intersection of solstice azimuths plotted by Horizon and the computer-generated horizon can be used to establish the point for determining horizon altitude.) Corrections for refraction (based on Wood, 1978, Fig. 4.5) were applied before entering the h values into the main formula. Calculations were made for lower limb tangency, meaning the bottom edge of the Sun.

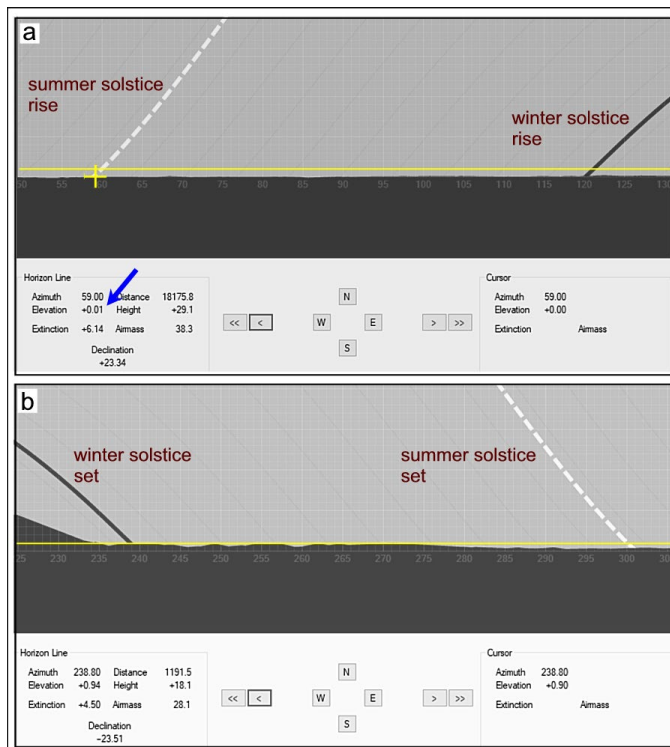

Figure 19a. East horizon profile with summer and winter solstice rise positions plotted using computer program Horizon. Yellow cross indicates cursor location with horizon altitude of $+0.01^\circ$ shown by blue arrow in data box. Horizon altitude of 1° enhanced by yellow line (Smith, 2012; annotations by author).

Figure 19b. West horizon profile with summer and winter solstice set positions plotted using computer program Horizon (Smith, 2012; annotations by author).

As Figure 18 shows, all four solstices are represented by mound-to-mound alignments across the design circle. For example, the summer solstice rise sightline (blue dotted arrow) drawn from the center of mound 15 intersects the center of mound 10 to within 0.5° . Similarly, the winter solstice rise sightline (blue dotted arrow) drawn from mound 17 intersects the center of mound 8 to within 0.5° . Looking the other way, the summer solstice set sightline (red solid arrow) drawn from mound 8 intersects mound 17 to within 0.5° . And the winter solstice set sightline (red solid arrow) drawn from mound 10 intersects mound 15 also to within 0.5° .

Given that we are working here with survey plats from the 1800s rather than modern surveys of extant mounds, the alignment results are impressive. Nevertheless, as indicated, posited alignments should be understood as accurate to $\pm 0.5^\circ$. This is due to uncertainties relating to horizon altitudes (e.g., unknown tree heights and clearing distances), variations in refraction due to departures from presumed standard conditions, and uncertainty as to whether upper limb, lower limb, or center tangency for the Sun was used as the visual reference by ancient skywatchers.

Landscape Alignments

Caves and Sinkholes

Thousands of caves are found in the state of Missouri (Weaver, 1980, p. 15). Before they were filled-in, sealed-off and otherwise destroyed, dozens were noted within the city limits of St. Louis. Indeed, Hubert and Charlotte Rother (1996) documented more than 30 cave entrances within the city limits. Figure 20 shows the cave entrances they recorded. This includes the supposed Big Mound cave (Rother and Rother, 1996, p. 123). As discussed below, there is little doubt that ancient Native Americans recognized and attributed significance to the network of caves, sinkholes and underground passages in the area. Suggestive evidence for this is found in an interesting alignment in the core group. This is a sightline that extends from mound 12 through mound 18 to a large sinkhole and cave entrance immediately northwest of mound 18. In Figure 18 this sightline is shown by a green arrow. The symmetrical location of mounds 12 and 18 on the circle relative to the other mounds suggests that the location for these two mounds (and perhaps the entire mound group) was deliberately chosen so as to integrate the cave alignment into the circle.

There is intriguing evidence suggesting that the mound 18 cave may have been used by Native Americans – but at what point in time remains unknown. The evidence is in the form of so-called hieroglyphs. An account authored by Robert D. Sutton for the *St. Louis Republican* newspaper, February 1869 relates the following:

About four hundred yards [365.8 m] southwest of the Mound [Big Mound] there was a cave in the rocks beneath the surface. To approach the entrance to this cave, you descended a ravine. To enter you descended a shaft about eight feet, when you stood upon the main floor of the cave. This cave was about one hundred yards [91.4 m] in diameter and its ceiling six to eight feet [1.8 to 2.4 m] in height. In it was a small spring of water, and on its walls could be seen numerous hieroglyphs of an unknown meaning, almost obliterated by the lapse of time.

The hieroglyphs mentioned by Sutton recall the Mississippian-era pictograph images found in Picture Cave (Diaz-Granados, Duncan & Reilly III, 2015), roughly 53 miles (85 km) northwest of the St. Louis caves.

A cave that is one hundred yards in diameter is not a trivial feature. And Sutton's recollection of a spring within the cave comports with similar reports of springs and underground watercourses within many of the St. Louis caves (Rother and Rother, 1996). I am speculating here, but if water from the spring inside the mound 18 cave flowed downslope toward the Mississippi River, then that underground stream could have passed under the mound group. Indeed, subterranean chambers formed by flowing water may be situated between the cave and river, thirty or forty feet below street level. This scenario is common among the St. Louis caves and has resulted in the somewhat regular occurrence of sinkholes opening and collapsing city streets (e.g., Rieck, 2022).

Did the mound builders recognize the existence of underground chambers or an underground stream beneath the mound group? There is no way of knowing. But many of the cave systems in St. Louis city have connecting passageways and multiple chambers stretching for hundreds of feet in multiple directions (see e.g., Cherokee and English caves (Rother & Rother, 1996, pp. 32, 60). Several St. Louis cave systems have multiple levels (Rother & Rother, 1996, pp. 77, 88). Indeed, underground passageways were so extensive that in the 1800s they were used throughout the city for the disposal of sewage and later for the distribution of hot steam from a steam plant on the river's edge to certain buildings in downtown St. Louis.

Perhaps related is a peculiar feature near Biddle Street that looks like it could be the result of a bluff slump due to underground water seepage (see Tainter, 1982). The feature appears in the 1875 Dry lithograph shown above as Figure 9. The feature needs on-site evaluation by a geologist and again I am just speculating; but if the feature is a bluff slump then it is worth noting that a straight line drawn from the mound 18 cave/sinkhole to the Biddle Street slump, cuts across (or underneath) the mound group (Fig. 12).

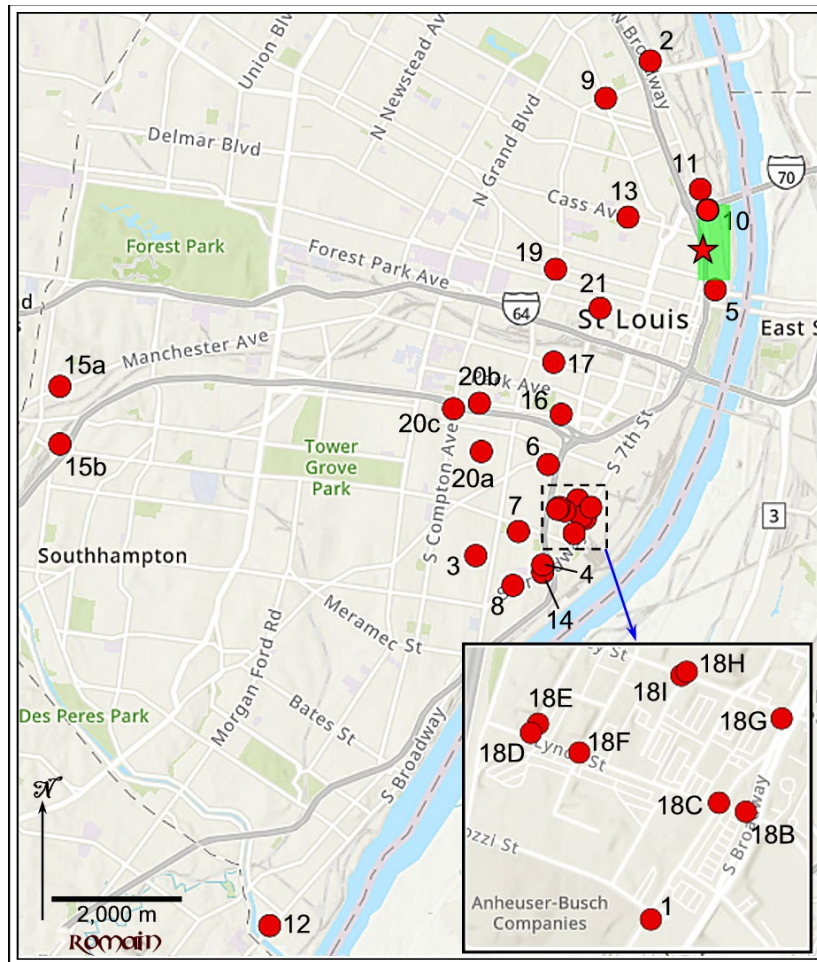

Figure 20. Known cave entrances plotted on ArcGIS base map. Location numbers 1-20c following Rother & Rother, 1996; with mound 18 cave entrance (shown by red star). For cave names see Appendix 2. Green rectangle shows general location for St. Louis Mound Group (Esri, 2023; Rother & Rother, 1996; annotations by author).

Lay of the Land and the Mississippi River

The St. Louis Mound Group could have been situated anywhere along the Mississippi River. However, several topographic considerations were apparently selected-for thereby resulting in its present location. For example, the mound group is situated at a high elevation overlooking the Mississippi River. Early commentators (Green, 1844, p. xix) mentioned the extensive view up and down the river from the Big Mound. And Monks Mound at Cahokia would easily have been visible from the Big Mound and *vice versa* (Fig. 21). In fact once the height of the Big Mound (ca. 35 feet or 10.7 m) is added to the base elevation of the Big Mound location (i.e., 438 feet [133.5 m]), it is found that the Big Mound and Monks Mound were to within ca. 25 feet (7.6 m) of each other in vertical height above mean sea level.

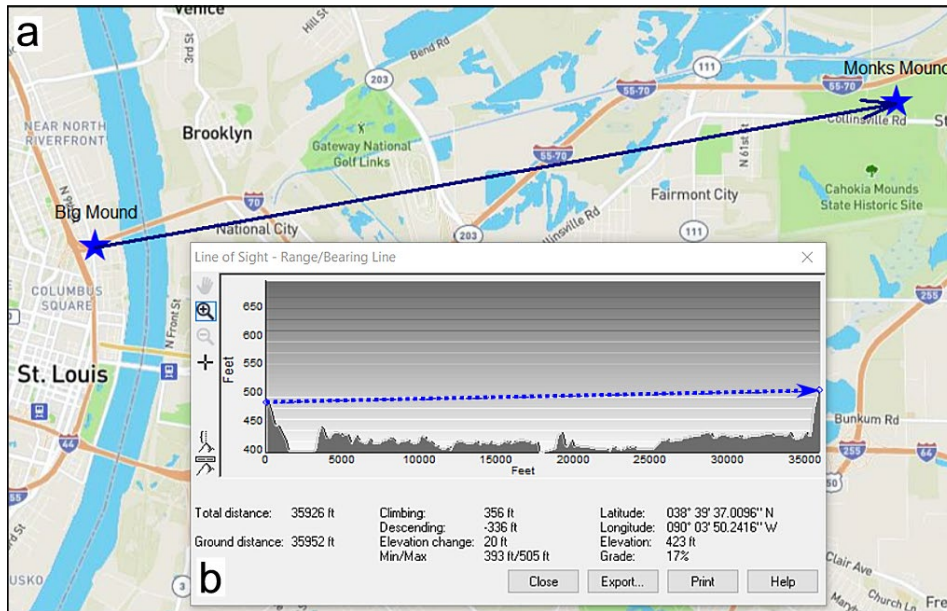

Figure 21a. Base map showing locations for Big Mound and Monks Mound with line of sight plotted (Terrain Navigator Pro, 2023).

Figure 21b. Line of sight (blue dashed line) and terrain profile between Big Mound and Monks Mound. Distance between the two mounds is 6.8 miles (10.9 km) at an azimuth of 79.8° (Terrain Navigator Pro, 2023).

Moreover, if the longitudinal axis of Big Mound is 178° then its orthogonal is 83°. If the 83° azimuth is plotted from the center of Big Mound it intersects the center of Cahokia at Fox Mound (Fig. 22). This also means that the east-facing lower platform of the Big Mound was oriented to the center of Cahokia. Given these geometric relationships there seems little doubt that the St. Louis Mound Group and Cahokia were intimately related.

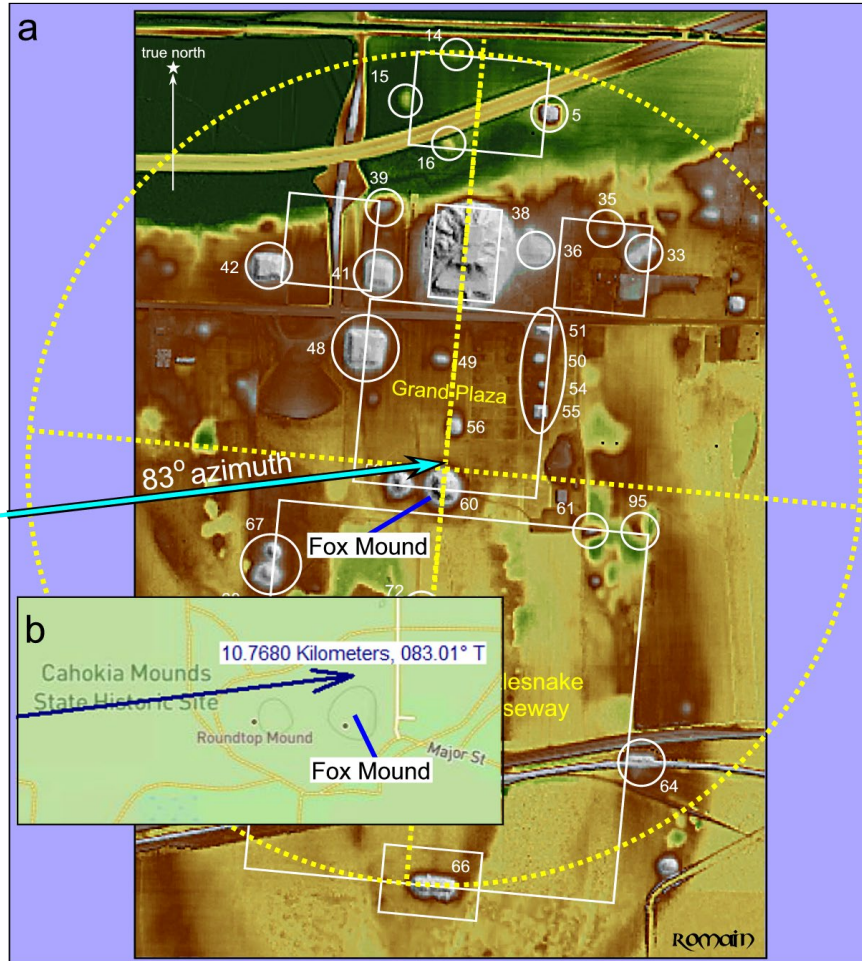

Figure 22a. LiDAR DTM (Digital Terrain Model) of Cahokia showing how 83° sightline (orthogonal to Big Mound major axis) plotted from center of Big Mound intersects the center of Cahokia at Fox Mound. Yellow dashed line circle extends from center of Cahokia mound 14 to center of mound 66 (Illinois Height Modernization [ILHMP] LiDAR Data, n.d.). Figure 22b. Enlarged detail of 83° azimuth computer plotted from center of Big Mound to Cahokia (Terrain Navigator Pro, 2023).

In addition to its orthogonal alignment to Cahokia, the longitudinal axis of Big Mound points directly to mound 19 of the St. Louis Mound Group, thus linking the Big Mound to the core group. Further, the longitudinal axes of Big Mound and the Falling Garden mound extend parallel to the lay of the land (Figure 23a) and the Mississippi River - presuming that the river's trajectory (constrained to some extent by high bluffs on its west side) one thousand years ago was roughly the same as it is today (Fig. 23b). Notable too is that the mound group is situated at a strategic bend in the river.

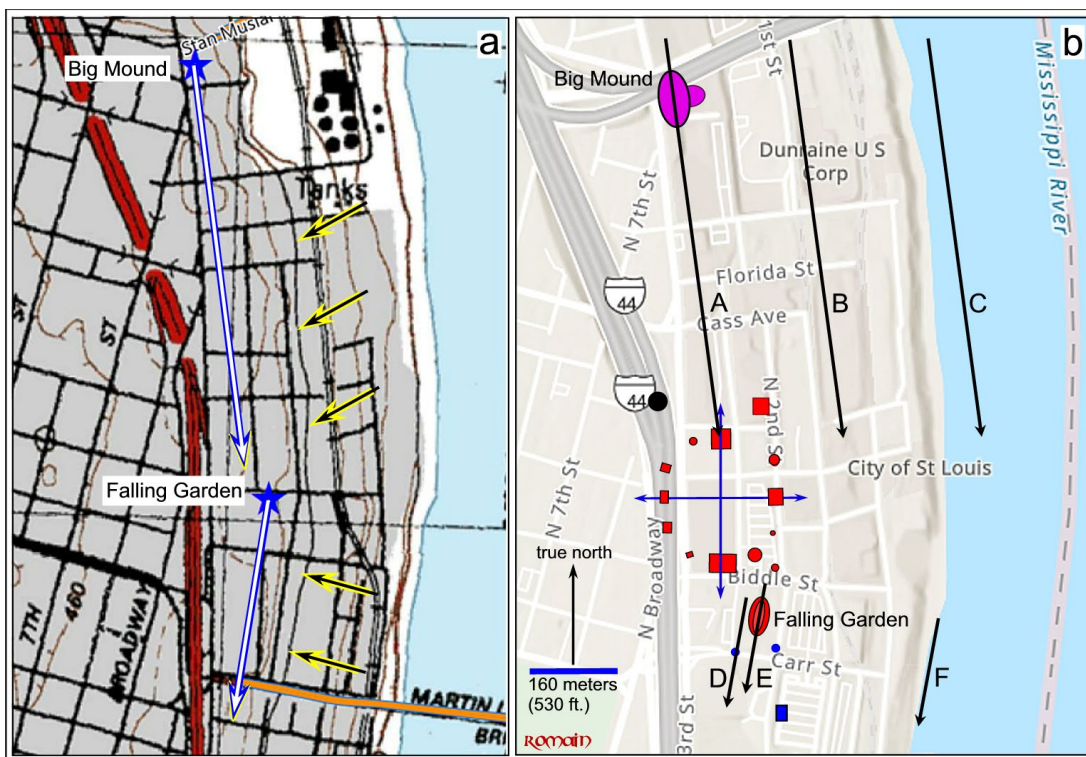

Figure 23a. United States Geological Survey (USGS) 7.5-minute topographic map showing contour lines at 10-foot intervals. White and blue arrows drawn by author show how major axes for Big Mound and Falling Garden Mound extend parallel to the lay of the land. Contour lines indicated by black and yellow arrows (Terrain Navigator Pro, 2023).

Figure 23b. Schematic plan of St. Louis Mound Group plotted on ArcGIS basemap. Longitudinal axes of the Big Mound and Falling Garden Mound (lines A and E) extend parallel to the lay of the land (dark shading and lines B and D) and Mississippi River (line F) (Esri, 2023; drawing by author; maps not to same scale).

Discussion

In the preceding pages several orientation protocols were identified – i.e., to the cardinal directions, solstice events, mound to mound, to a cave entrance, and parallel to the lay of the land and Mississippi River. Ruggles (2015a, p. 412) reminds us that there can be “many reasons” for a structure “to be oriented in a particular direction” and orientations need not be mutually exclusive.

We may never know with certainty why the St. Louis Mound Group was laid-out the way it was. There are, however, a couple of observations that can be made. To begin with, I suggest that the core mound group established a cosmic center. The circular mound layout implies a center – which in this case is indicated by the rise in topography shown on the Peale map at the center of the mound circle. Additionally, the cardinal direction alignments across the mounds established the four directions, four quarters, and perhaps the Four Winds. The intersection of the cardinal directions creates a center around which space is organized (Romain, 2015a, pp. 89–91).

Reinforcing the concept of center are the solstice alignments – again, extending across the circle of mounds and intersecting at, or near the center. Solstice alignments perhaps provided a sense of time, with the cyclic nature of time referenced as the Sun moved back and forth across the circle and north and south between its extremes. Some of the mounds are low in height making observations across the circle problematic. If, however, upright posts had been erected on the mounds then those features might have been useful for keeping track of the seasons and timing ceremonial events.

It may also be that individual mounds on the circle were associated with specific clans, or societies. Among the Osage, for example, camps were laid out in a circle with different kinship groups, subgroups, or gens positioned around the circle (see Fletcher & La Fleshe, 1911, Fig. 9). The design concepts just noted are not mutually exclusive.

Most, if not all Native American tribes consider the cosmos to be vertically layered. Some believe the cosmos to be comprised of an Above World, This World, and Below World (see Hudson, 1976, pp. 127-128 regarding the Cherokee). Others, such as the Osage (Bailey, 1995, p. 31) recognize two major divisions – i.e., the Earth and Sky with people living on the surface of the Earth. In either case, a vertical axis mundi links the realms. For the St. Louis Mound Group, the axis mundi concept appears expressed in multiple ways. First, the projection of the Big Mound extending upward toward the sky established a vertical component for the mound group. Looking the other way the sightline from mound 12 through mound 18 to the mound 18 sinkhole and cave established the axis mundi in the opposite direction, to the Below World. By these features and alignments an axis mundi was created that connected the cosmic realms.

By far, the majority of reported burials were found in the Big Mound. Certainly this would be appropriate if, due to its liminal location between the Above World and Below World, the Big Mound was thought of as a gateway between realms for souls of the dead.

In this regard there is a notable similarity in the shape of the Big Mound to the ridge-top mounds at Cahokia to include Rattlesnake Mound. In an earlier article (Romain, 2021a) I suggested how Rattlesnake Mound might have been intended as an entry point or portal to the Milky Way Path of Souls and Land of the Dead. I believe the same concept holds true for Big Mound. In this case, however, access to the Other World and Land of the Dead may have been through multiple conduits to include caves and subterranean passageways, the Mississippi River, and Milky Way.

As to caves, there is a significant body of literature documenting how in North America, caves were considered entrances to the Below World (e.g., Moyes, 2012; Stone, 1995; Brady & Prufer, 2005). As explained by Simek, et al. (2021, p. 198): “Caves were openings to the underworld and were used by human souls as pathways on their journey after death.” Similarly, Joseph Harl (personal interview quoted in Leach 2017, 42) observes: “Water was seen as a portal to the beneath world: springs, lakes, sink holes. Caves were also seen as portals to the beneath world, so those are very sacred

locations....Again, springs and caves are seen as portals into the beneath world, so it's not unusual to have mounds above them.”

As noted, among many Native American tribes, rivers were also believed to be conduits to the Below World (Hudson 1976; Reilly 2004). Again quoting Simek et al. (2021, p. 199): “rivers themselves were spiritually important to southeastern Native peoples, often serving as portals to the spirit world.”

As discussed in detail elsewhere (Lankford 2007; Romain 2021a) the Milky Way was considered the Path of Souls by many Native American tribes. It was the road by which souls travelled from This World to the Land of the Dead. Alignments to the Milky Way have been documented for several Mississippian sites including Cahokia, Moundville, and Angel (Romain 2021a, 2021b; Romain & Herrmann 2022). Not surprisingly, there is also a prominent alignment to the Milky Way at the St. Louis Mound Group. At the vernal equinox (when the seasons are balanced, night and day are of equal length, and life begins again or is renewed) (and where equinox in this instance corresponds to the alignment of mound 16 through mound 9 to the cardinal direction of east), at nightfall (19h 41m, A.D. 1050, March 14, Julian calendar), the 173° longitudinal axis of the Big Mound pointed directly to the southern end of the Milky Way – ostensibly where the Land of the Dead was located and final destination for souls. Figure 24 shows the alignment.

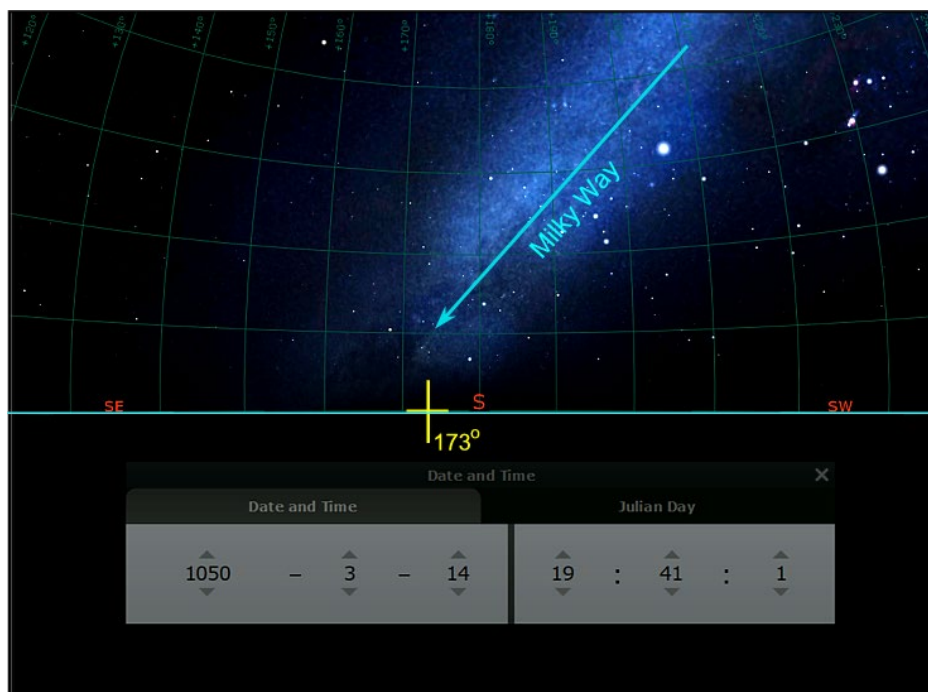

Figure 24. Stellarium computer simulation of the night sky as viewed from Big Mound looking south on the night A.D. 1050 equinox (based on cardinal direction of east, with 0° horizon altitude – see Figure 19a) at nightfall. Atmospheric effects turned on. In A.D. 1050 the vernal equinox occurred on Julian date March 14. Sunset was at 18^h 09^m, with nightfall at 19^h, 41^m (local standard time). Nightfall is when all the stars visible to the naked eye can be seen. It

occurs when the Sun is 18° below the horizon. The same view would apply for several hundred years preceding and following. Of note, the longitudinal axis of Big Mound (i.e., 173°) points to where the Milky Way meets the horizon (Zotti et al., 2021; Stellafane, 2021; Bowditch, 1802/2017, Table 1316).

What I am getting-at is that caves and underground passages, the Mississippi River and its iterations and the Milky Way are in a sense, manifestations of the same phenomenon – i.e., all are conduits. Caves, the river, and Milky Way are metonymous in that all are passageways between realms. They connect This World to the Below World, Otherworld, and Land of the Dead. Seemingly different paths (earth, water, sky) may have been for people who died in different ways, or at certain times of the year, or who were in some way socially distinguished from others. Whether by underground passage, flowing river, or Milky Way Road, however, all humans eventually journeyed along some iteration of the Path – presumably (or in most instances) to the Land of the Dead.

Conclusion

It is my hope that the preceding work has demonstrated that even when an ancient site appears obliterated, it is possible to retrieve useful information using old maps (if shown to be accurate) when combined with new technologies. Using this approach the probable location for the St. Louis Mound Group was identified, and the first-ever archaeoastronomic and landscape assessments for the mound complex presented. Alignments to the cardinal directions, solstices and Milky Way were documented. Indeed, the manner in which the core group mounds were positioned so that all eight solstice and cardinal directions were expressed in one design is unique. No other Native American earthwork manifests these major alignments in such a way. Further it was shown how the site was laid-out relative to the lay of the land, Mississippi River and in association with a significant cave complex. Together, these relationships suggest that the St. Louis Mound Group was a center place connecting the Earth, Sky and Below World realms to the living and the dead. In this another chapter is added to the knowledge base concerning ancient Mississippian cultural expressions.

Acknowledgements

Earlier work by Mark Leach (author and independent researcher) and Dr. John B. Marshall (physician and researcher) provided many of the primary references found in the present paper. Their work saved me many hours of library research. I am most grateful to these gentlemen. For maps, information and other help, my sincere thanks to: Jaqueline Walters (Missouri Department of Agriculture Land Survey Program), Jason D. Stratman, Lauren Sallwasser, Jamie Bourassa (Missouri Historical Society), Bill Kranz (McHose and English Cave Recovery Project), Edward W. Herrmann (Indiana University, Department of Earth and Atmospheric Sciences), the Missouri Archaeological Society, Bob Sabler (American Resources Group, Ltd.) and Thomas J.

Evers, Shaun Tooley, Michael Myer, Mike Meinkoth, and Melissa A. Scheperle (Missouri Department of Transportation). I am solely responsible for any errors.

References

- Adam, G. M. (1905). *The life of General Robert E. Lee*. A. L. Burt.
<https://archive.org/details/lifeofgeneralrob00adam>
- Bailey, G. A. (Ed.). (1995). *The Osage and the invisible world: From the works of Francis La Fleshe*. University of Oklahoma Press.
- Beck, L. C. (1823). *A gazetteer of the states of Illinois and Missouri*. Charles R. and George Webster. <http://www.archive.org/details/gazetteerofstateOObeck>
- Bowditch, N. (2017). *American practical navigator: An epitome of navigation*. National Geospatial-Intelligence Agency. (Original work published 1802)
- Brady, J. E., & Prufer, K. M. (Eds.). (2005). *In the maw of the earth monster. Mesoamerican ritual cave use*. University of Texas Press.
- Chamberlain, V. D. (1982). *When stars came down to earth: Cosmology of the Skiri Pawnee Indians of North America*. Anthropological Papers, No. 26. Ballena Press.
- Clark, M. L. (1849). *Diagram of the state of Missouri* [plat map]. Office of the Surveyor General for the States of Illinois and Missouri.
<https://collections.lib.uwm.edu/digital/collection/agdm/id/28668/>
- Compton, R. J., & Dry, C. N. (1876). *Pictorial St. Louis, the great metropolis of the Mississippi Valley; A topographical survey drawn in perspective A.D. 1875*. Compton & Co. Retrieved from Library of Congress at
<https://loc.gov/resource/g4164sm.gpm00001/?sp=1&st=image>
- Conant, A. J. (1879). *Footprints of vanished races in the Mississippi Valley; being an account of some of the monuments and relics of pre-historic races scattered over its surface, with suggestions as to their origins and uses*. Chancy R. Barnes.
<http://users.stlcc.edu/mfuller/StLouisMound.html>
- Diaz-Granados, C., Duncan, J. R., & Reilly III, F. K. (2015). *Picture Cave: Unraveling the mysteries of the Mississippian cosmos*. University of Texas Press.
- Duncan, J. R. (2011). The cosmology of the Osage: The star people and their universe. In G. E. Lankford, F. K. Reilly III & J. E. Garber (Eds.), *Visualizing the sacred: Cosmic visions, regionalism, and the art of the Mississippian world* (pp. 18–33). University of Texas Press.
- Duncan, J. R., & Diaz-Granados, C. (2000). Of masks and myths. *Midcontinental Journal of Archaeology*, 25(1), 1–26.
- Esri. (2023). ArcGIS Online (Computer software). <https://www.esri.com/en-us/arcgis/products/arcgis-online/overview>

- Federal Emergency Management Agency (FEMA). (2011). FIRM flood insurance rate map city of St. Louis, map number 2903850068C.
<https://msc.fema.gov/portal/search?#searchresultsanchor>
- Flagg, E. (1838). *The Far West or, a tour beyond the mountains, 1836-1837* (Vol. I). Harper and Bros. (Reprinted from *Early Western travels, 1748-1846* (Vol. 26, pp. 152–162), 1906. Arthur H. Clark. <https://www.gutenberg.org/files/42322/42322-h/42322-h.htm>
- Fletcher, A. C., & La Flesche, F. (1911). The Omaha tribe. In *Twenty-seventh annual report of the Bureau of American Ethnology, 1905-1906*, pp. 17–654. Smithsonian Institution, Bureau of American Ethnology.
- Google Earth Pro. (n.d.). Ver 7.3.6.9345, computer software.
<https://google.com/earth/desktop/>
- Green, J. (1844). *Green's St. Louis directory for 1845 containing the names of the inhabitants, their occupations, places of business, and dwelling houses; Also a list of the streets and alleys; Together with other useful information*. Green and Cathcart & Prescott.
- Gurley, W., & Gurley, L. E. (1910). *A manual of the principal instruments used in American engineering and surveying* (45th ed.). W. & L. E. Gurley.
<https://www.compleatsurveyor.com/eReferenceSolar/eRefSolar.html>
- Hoffman, C. F. (1835). *A winter in the West. By a New Yorker* (Vol 1 & vol 2). Harper & Bros.
<https://archive.org/details/winterinwestho02hoff/page/n6/mode/1up?ref=ol&view=theater>
- Hudson, C. (1976). *The Southeastern Indians*. University of Tennessee Press.
- Illinois Height Modernization [ILHMP] LiDAR Data. (n.d.). LiDAR DTM (Digital Terrain Model) of Cahokia.
<https://www.arcgis.com/apps/webappviewer/index.html?id=44eb65c92c944f3e8b231eb1e2814f4d>
- James, E. (Comp). (1823). *An account of an expedition from Pittsburgh to the Rocky Mountains, performed in the years 1819, 1820* (Vol. 1). Biodiversity Library.
<https://www.biodiversitylibrary.org/item/124314#page/7/mode/1up>
- Lankford, G. E. (2007). The 'Path of Souls': Some death imagery in the Southeastern Ceremonial Complex. In F. K. Reilly III & J. F. Garber (Eds.), *Ancient objects and sacred realms: Interpretations of Mississippian iconography* (pp.174–212). University of Texas Press.
- Leach, M. W. (2017). *The great pyramids of St. Louis: An ancient metropolis*. CreateSpace Independent Publishing Platform.
- Kavanaugh, M. O. (2017). *Hidden history of downtown St. Louis*. The History Press.
- Marshall, J. B. (1992). The St. Louis Mound Group: Historical accounts and pictorial depictions. *Missouri Archaeologist*, 53, 43–79.

- McCormac, J. C. (1983). *Surveying fundamentals*. Prentice Hall.
- Missouri Department of Agriculture Land Survey Index. (n.d.). Survey plat from 1852. Index document #Y9903892. <https://apps.mda.mo.gov/molandsurveyindex/>
- Missouri Historical Society. (n.d.-a). 1855 survey plat by Nathaniel F. Hyer, County Surveyor. La Beaume Collection. <https://mohistory.org/research/photographs-prints/photograph-print-collection-guides-and-finding-aids>
- Missouri Historical Society. (n.d.-b). Lithograph from 1852 by John W. Hill. <http://collections.mohistory.org/resource/921526>
- Moyes, H. (Ed.). (2012). *Sacred darkness: A global perspective on the ritual use of caves*. University Press of Colorado.
- National Museum of American History (2023). *Solar compass*. https://americanhistory.si.edu/collections/search/object/nmah_747075
- NOAA (National Oceanic and Atmospheric Administration). (2023). *Magnetic field calculators*. <https://www.ngdc.noaa.gov/geomag/calculators/magcalc.shtml>
- Panno, S. V., Weibel, C. P., Wicks, C. M., & Vandike, J. E. (1999). Geology, hydrology, and water quality of the karst regions of southwestern Illinois and southeastern Missouri. Geological Field Trip 2, April 24–25, 1999. *Illinois State Geological Survey, Guidebook 27*.
- Peale, T. R. (1862). *Ancient mounds at St. Louis, Missouri, in 1819*. In Annual Report, Board of Regents of the Smithsonian Institution for the Year 1861 (pp. 386–391). U.S. Government Printing Office.
- Pryor, J. (2011). President's page, progress notes for April 11, 2011. Miller County Museum and Historical Society. <http://www.millercountymuseum.org/archives/110411.html>
- Rieck, D. (2022, June 10). Rain causes St. Louis street to collapse, creating 40-foot crater. *St. Louis Post-Dispatch*. https://www.stltoday.com/news/local/accident-and-incident/rain-causes-st-louis-street-to-collapse-creating-40-foot-crater/article_b6ce83a6-f413-535c-81d1-0cc6667dff32.html
- Reilly III, F. K. (2004). People of earth, people of sky: visualizing the sacred in native American art of the Mississippian Period. In R. F. Townsend and R. V. Sharp (Eds.), *Hero, hawk, and open hand: American Indian art of the ancient Midwest and South* (pp. 125–137). Yale University Press.
- Richards, T. T. (1870). Relics from the Great Mound. Letter to Frederic W. Putnam. *American Naturalist*, IV(1), 62–63. <https://www.jstor.org/stable/2446961?seq=2>
- Rogers, L. D., & Pulcher, R. E. (1987). St. Louis Harbor District properties reconnaissance, city of St. Louis, Missouri. Part I. Archaeological Investigations. In *U.S. Army Corps of Engineers, St. Louis District Cultural Management Report No. 31* (pp. 1–48). American Resources Group.
- Romain, W. F. (2015a). *Shamans of the lost world: A cognitive approach to the prehistoric religion of the Ohio Hopewell*. AltaMira Press.

- Romain, W. F. (2015b). Adena-Hopewell earthworks and the Milky Way Path of Souls. In M. E. Buchanan and B. J. Skousen (Eds.), *Tracing the relational: The archaeology of worlds, spirits, and temporalities* (pp. 54–82). University of Utah Press.
- Romain, W. F. (2015c). *An archaeology of the sacred: Adena-Hopewell astronomy and landscape archaeology*. CreateSpace Independent Publishing Platform.
<https://indiana.academia.edu/WilliamRomain>
- Romain, W. F. (2021a). Following the Milky Way Path of Souls: An archaeoastronomic assessment of Cahokia's main site axis and Rattlesnake Causeway. *Journal of Skyscape Archaeology*, 7(2), 187–212.
- Romain, W. F. (2021b). *Crossing to the Land of the Dead: Earthen causeways at Cahokia and the Milky Way Path of Souls*. Paper presented at the Theoretical Archaeology Group (Europe) annual meeting for 2021.
<https://indiana.academia.edu/WilliamRomain>
- Romain, W. F., & Herrmann, E. (2022). An archaeoastronomic assessment of Angel Mounds, Indiana, with commentary on Moundville, Alabama, and Cahokia, Illinois. *Midcontinental Journal of Archaeology*, 47(1), 25–46.
- Rother, H., & Rother, C. (1996). *Lost caves of St. Louis: A history of the city's forgotten caves*. Virginia Publishing.
- Ruggles, C. L. N. (2015a). Analyzing orientations. In C.L.N Ruggles (Ed.). *Handbook of archaeoastronomy and ethnoastronomy* (Vol. 1, pp. 411–425). Springer.
<https://doi.org/10.1007/978-1-4614-6141-8>
- Ruggles, C. L. N. (2015b). Long term changes in the appearance of the sky. In C.L.N Ruggles (Ed.). *Handbook of archaeoastronomy and ethnoastronomy* (Vol. 1, pp. 473–482). Springer. <https://doi.org/10.1007/978-1-4614-6141-8>
- Simek, J. F., Dunsmore, E. E., Loubser, J., & Bow, S. M. (2017). *The cosmos revealed: Precontact Mississippian rock art at Painted Bluff, Alabama*. University of Alabama Press.
- Smith, A. (2012). Horizon (Ver 0.13c) [Computer software].
<http://www.agksmith.net/horizon/>
- Smith, S. (1869, September 7). Origin of the Big Mound of St. Louis, a paper read before the St. Louis Academy of Science, St. Louis. *Missouri Daily Democrat*, 17(205). <https://www.newspapers.com>
- Stellafane (2021). Equinox and solstice calculator [Computer program].
<https://stellafane.org/misc/>
- Stone, A. J. (1995). *Images from the underworld. Naj Tunich and the tradition of Maya cave painting*. University of Texas Press.
- Tainter, S. P. (1982). *Bluff slumping and stability: A consumer's guide*. Michigan Sea Grant Publication 82–902. US Geological Survey.
<https://repository.library.noaa.gov/view/noaa/38960>

- Terrain Navigator Pro. (2023). Ver. 12.2.1.193 [Computer software]. Trimble Inc.
- The Library of Congress. (n.d.). Dry, 1876, plate 19. Geography and Map Division.
<https://www.loc.gov/rr/geogmap/>
- The State Historical Society of Missouri. (n.d.). Map made in 1837 by Lt. Robert E. Lee and Lt. M. C. Meigs. Digital Collections.
<https://digital.shsmo.org/digital/collection/Maps/id/8/rec/22>
- United States General Land Office. (1855). *Instructions to the surveyors general of public lands of the United States, for those surveying districts established in and since the year 1850; containing, also, a manual of instructions to regulate the field operations of deputy surveyors.*
- University of Missouri St. Louis Digital Library. (n.d.). Map made in 1846 by Edward and Julius Hutawa.
<https://dl.mospace.umsystem.edu/umsl/islandora/object/umsl%3A32933>
- Weaver, H. D. (1980). *Missouri the cave state*. Discovery Enterprises.
- White, C. A. (1983). *A history of the Rectangular Survey System*. United States Department of the Interior, Bureau of Land Management. US Government Printing Office. <https://www.blm.gov/sites/blm.gov/files/histrect.pdf>
- Williams, S., & Goggin, J. M. (1956). The long nosed god mask in Eastern United States. *The Missouri Archaeologist*, 18(3), 1–72.
- Winter, W. C. (1999). Clark, Meriwether Lewis (1809-1881). In L. O. Christensen, W. E. Foley, G. R. Kremer, and K. H. Winn (Eds.), *Dictionary of Missouri biography* (pp. 188-189). University of Missouri Press.
- Wood, J. E. (1978). *Sun, moon and standing stones*. Oxford University Press.
- Zotti, G., Hoffman, S. M., Wolf, A., Chéreau, F., & Chéreau, G. (2021). The simulated sky: Stellarium for cultural astronomy research. *Journal of Skyscape Archaeology*, 6(2), 221–258. <https://doi.org/10.1558/jsa.17822>

Appendix 1

Locations and Dimensions of Mounds (from Peale 1862, pp. 388-391).

“What we have called *base* in the following statement is in reality the length of a line passing over the top of the mound from the termination of the base each side. The numbers refer to the map. The heights are estimated, with the exception of two.

No. 1. is the remains of what was reported to be the bastion of an old Spanish stockade, indications of a ditch being still visible.

No. 2. A square with a hollow way, gradually sloping to the top; or in other words, a hollow square, open behind.

Base	50 feet
Height	5 feet
Distance north from the Spanish bastion	259 feet

No. 3. An oblong square.

Longitudinal base	114 feet
Transverse base	50 feet
Length at top (or flattened portion)	80 feet
Perpendicular height	4 feet
Distance from No. 2 north	115 feet

No. 4. An oblong square.

Longitudinal base	84 feet
(Flattened portion) top	45 feet
Perpendicular height	4 feet
Distance north from No. 3	251 feet

Nos. 2, 3, and 4 are each about 33 ordinary paces from the edge of the second bank of the river.

No. 5. An oblong square; longitudinal base	81 feet
Top	35 feet
Perpendicular height	4 feet
Distance west from No. 4	155 feet

No. 6. Different in form from the others. It is called the *Falling Garden*, and consists of three stages, all of equal length and of the same parallelogramic form. The superior stage, like the five succeeding mounds, is bounded on the east by the edge of the second bank of the river. The second and third stages are in succession on the declivity of the bank, each being horizontal, and are connected with each other, and with the first, by an abruptly-oblique descent.

Longitudinal base	114 feet
Top or flat portion	88 feet

Transverse base of the first stage	30 feet
Height of the first stage	5 feet
Declivity to the second stage	34 feet
Transverse surface of the second stage	51 feet
Declivity to the third stage	30 feet
Transverse surface of third stage	87 feet
Declivity to the natural slope (on the east)	19 feet
No. 7. Like the three succeeding ones, conical.	
Distance northward from No. 6	95 feet
Base	83 feet
Top	34 feet
Height	4½ feet
No. 8. Distance about north from No. 7	94 feet
Base	98 feet
Top	31 feet
Height	5 feet
No. 9. Distance about north from No. 8	70 feet
Base	114 feet
Top	56 feet
Height	16 feet
No. 10. Distance about north	74 feet
Base	91 feet
Top	34 feet
Height	8 or 10 feet
No. 11. Nearly square, with a large area on the top; (a brick house is erected at the southwest corner.) The eastern side appears to range with the preceding mounds.	
Distance	158 feet
Base	179 feet
Top	107 feet
Height, west side, say	5 feet
Height, south side	11 feet
Height, east side	15 or 20 feet
No. 12. Nearly square, westwardly, a little north from No. 7, and distant from it	30 feet
Base	129 feet
Top	50 feet
Height	10 feet
No. 13. A parallelogram placed transversely, with respect to the group.	
Distance	30 feet
Distance from No. 5 north 10 west	350 feet

Longitudinal base	214 feet
Top	134 feet
Traverse base	188 feet
Top	97 feet
Height	12 feet
No. 14. A convex mound, west	55 feet
Base	95 feet
Height	56 feet
No. 15. Together with the succeeding ones, more or less square	
Distance northwest	117 feet
Base	70 feet
Height	4 feet
No. 16. Distance north 10 east	103 feet
Base	124 feet
No. 17. Distance north	78 feet
Base	82 feet
No. 18. Distance north northeast	118 feet
Base	77 feet

The mounds from 14 to 18, inclusive, are so arranged as to form a curve, which, when continued, terminates at the larger mounds Nos. 15 and 19.

No. 19. A large quadrangular mound, placed transversely, and with No. 13, ranging in a line nearly parallel to the principal series (from 2 to 11).

Distance north northwest from No. 13	484 feet
Distance east northeast from No. 18	70 feet
Base	187 feet
Top	68 feet
Height (by measurement)	23 feet

No. 20. A small barrow, perhaps two feet high, and of proportionably rather large base, say 15 or 20 feet.

No. 21. A mound similar to the preceding, same height, west of No. 16

Base	25 feet
------	---------

No. 22. Quadrangular, distance west from No. 16

Base	319 feet
Base	73 feet

No. 23. A mound of considerable regularity, but owing to the thickness of the bushes we cannot at present satisfy ourselves of its being artificial, though from its corresponding with No. 25, we suppose it to be so.

No. 24. Appears to be an irregular mound ten or twelve feet high, and one hundred and forty-five feet base.

No. 25. Distant north 10 east one hundred and fourteen feet, and following this course one hundred and thirty-two feet we arrive at an elevation on its margin, as is also the case with No. 24, and which we have numbered 26.

No. 26. Of which the base is eighty-nine feet and height ten or twelve. It is distant W.NW. from No. 19, 538 feet.

No. 27. Is the largest mound, of an elongated-oval form, with a large step on the eastern side, distance north from No. 26

	1,463 feet
Longitudinal base	319 feet
Longitudinal top	136 feet
Transverse base	158 feet
Transverse top	11 feet
Step transversely	79 feet
Height by measurement	34 feet

Appendix 2

St. Louis Caves (following Rother and Rother 1996, p. 21).

1. Anheuser Bush Cave. East side of Carondelet (now S. Broadway and Arsenal).
2. Bremen. N. Broadway and Bremen Avenue.
3. Cherokee Brewery. 2726 Cherokee.
4. Cherokee Cave. Cherokee and 7th.
5. St. Louis Brewery. Franklin between 2nd and Broadway.
6. Consumer's Brewery Cave. 1920 Shenandoah.
7. English Cave. East of Benton Park between Arsenal and Wyoming.
8. Home Brewery Cave. Corner of Miami and Wisconsin.
9. Hyde Park. Salisbury and North Florissant.
10. Indian Mound. Broadway near Brooklyn Avenue.
11. Kerzinger's. Southeast corner of Broadway and Tyler.
12. Klausman Cave. 8639 South Broadway.
13. Lafayette Cave. 1714 Cass Avenue.
14. Lemp Cave. South of Cherokee Cave on South Broadway.
15. Natural Caves
- 15a. 2005 Benton southwest to Ecoff and Manchester avenues.
- 15b. Hudler and Hoffman.
16. Phoenix Brewery Cave (Old Staehlin brewery). 18th and Lafayette.
17. Schnaider's Brewery Cave. Chouteau Avenue between Armstrong and Mississippi.
18. Sidney Street Brewery Caves (probably all the same cave).
- 18a. Whitteman and Rost Weiss. 211 Anna (now St. George).
- 18b. Theo Schwer. 709-15 Lynch near South Broadway.
- 18c. Excelsior. 7th and Lynch.
- 18d. Pittsburg. Rosati (now 12th) and Lynch.
- 18e. Jackson Brewery. Same block as above.
- 18f. Arsenal. 11th and Lynch.
- 18g. Suesert and Berger. South side of Sidney and west of 7th.
- 18h. Schlop. Sidney Street north near Buel (now 10th).
- 18i. Gambrinus. Sidney and 10th.
- 18j. Koch and Feldkamp. South Sidney.
19. Uhrig's Cave. Locust and Washington Avenues, beneath 18th Street between Jefferson and Delmar.
20. Wild Caves.
- 20a. North of California and Sidney.
- 20b. East under Nebraska near Lafayette.
- 20c. 1900 South Compton Avenue

21. Winkelmeier and Excelsior Cave. Stretches between 17th and 18th under Market.