

# Lawrence Berkeley National Laboratory

## Recent Work

### Title

MOLECULAR BEAM STUDIES OF ELEMENTARY CHEMICAL PROCESSES

### Permalink

<https://escholarship.org/uc/item/2zv9n7wm>

### Author

Lee, Y.T.

### Publication Date

1987-02-01



# Lawrence Berkeley Laboratory

UNIVERSITY OF CALIFORNIA

## Materials & Chemical Sciences Division

RECEIVED  
LIBRARY  
BERKELEY, CALIF. 94720

APR 22 1987

Submitted to Science

LIBRARY AND  
DOCUMENTS SECTION

### MOLECULAR BEAM STUDIES OF ELEMENTARY CHEMICAL PROCESSES

Y.T. Lee

February 1987

**TWO-WEEK LOAN COPY**  
This is a Library Circulating Copy  
which may be borrowed for two weeks.

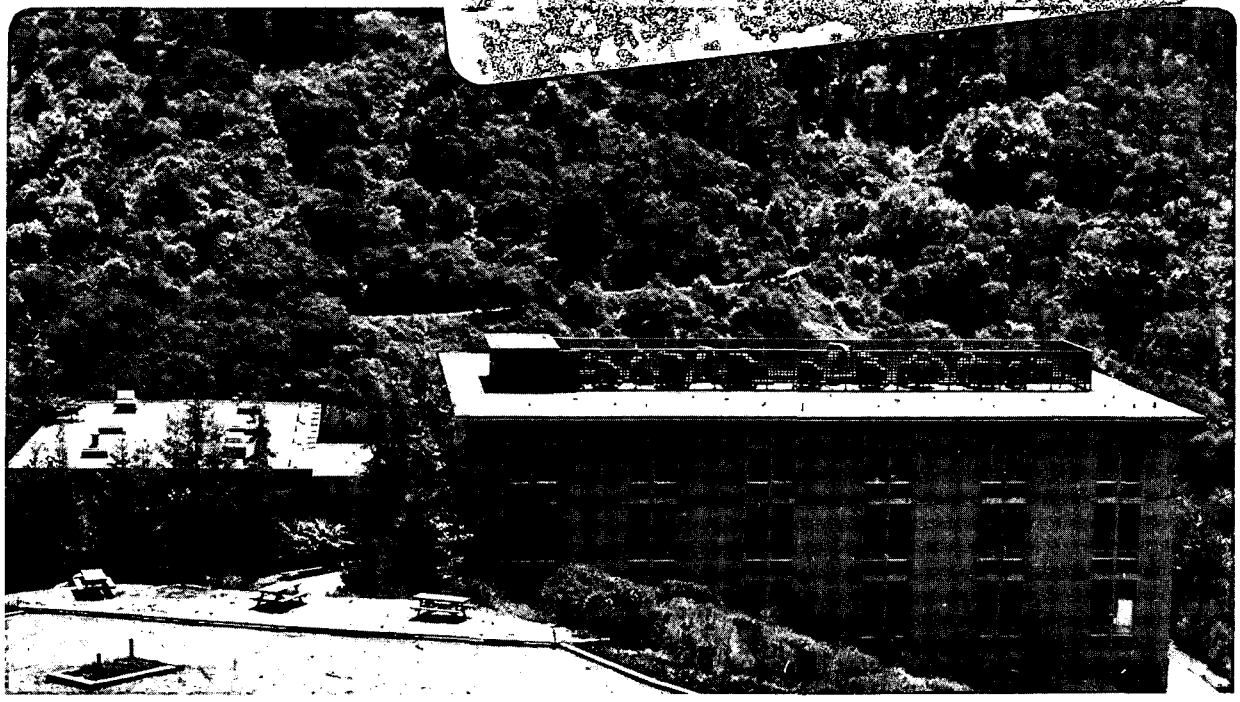

LBL-22982  
c.2

## **DISCLAIMER**

This document was prepared as an account of work sponsored by the United States Government. While this document is believed to contain correct information, neither the United States Government nor any agency thereof, nor the Regents of the University of California, nor any of their employees, makes any warranty, express or implied, or assumes any legal responsibility for the accuracy, completeness, or usefulness of any information, apparatus, product, or process disclosed, or represents that its use would not infringe privately owned rights. Reference herein to any specific commercial product, process, or service by its trade name, trademark, manufacturer, or otherwise, does not necessarily constitute or imply its endorsement, recommendation, or favoring by the United States Government or any agency thereof, or the Regents of the University of California. The views and opinions of authors expressed herein do not necessarily state or reflect those of the United States Government or any agency thereof or the Regents of the University of California.

MOLECULAR BEAM STUDIES OF ELEMENTARY CHEMICAL PROCESSES

Yuan Tseh Lee

Lawrence Berkeley Laboratory  
University of California  
Berkeley, California 94720

February 1987

MOLECULAR BEAM STUDIES OF ELEMENTARY CHEMICAL PROCESSES

Yuan Tseh Lee

Chemistry is the study of material transformations. Yet a knowledge of the rate, or time dependence, of chemical change is of critical importance for the successful synthesis of new materials and for the utilization of the energy generated by a reaction. During the past century it has become clear that all macroscopic chemical processes consist of many elementary chemical reactions that are themselves simply a series of encounters between atomic or molecular species. In order to understand the time dependence of chemical reactions, chemical kineticists have traditionally focused on sorting out all of the elementary chemical reactions involved in a macroscopic chemical process and determining their respective rates.

Our basic understanding of the relation between reactive molecular encounters and rates of reactions (formulated in terms of activation energies,  $E_a$ , and pre-exponential factors,  $A$ , as elucidated by Arrhenius in his rate constant expression,  $k=A\exp(-E_a/kT)$ ), was deepened some fifty years ago following the discovery of quantum mechanics. Since a chemical reaction is fundamentally a mechanical event, involving the rearrangement of atoms and molecules during a collision, detailed information on the dynamics of simple chemical reactions could be obtained by first carrying out extensive quantum mechanical calculations of the interaction potential as a function of interatomic distances and then computing classical trajectories

based on this potential energy surface.<sup>1</sup> Although these initial theoretical studies were only qualitative, they heralded a new era in the field of chemical kinetics; the chemist could now, in principle, predict the dynamical course of a chemical reaction.

During the past three decades, with the development of many sophisticated experimental techniques, it has become possible to study the dynamics of elementary chemical reactions in the laboratory. For example, detailed information on the nascent quantum state distributions of simple products for some chemical reactions can be derived from the chemiluminescence spectra of reaction products obtained under single collision conditions,<sup>2</sup> the analysis of the threshold operating conditions of a chemical laser,<sup>3</sup> or the spectra obtained using various linear or non-linear laser spectroscopic techniques.<sup>4,5</sup> However, when one desires to (1) control the energies of the reagents, (2) understand the dependence of chemical reactivity on molecular orientation, (3) explore the nature of reaction intermediates and their subsequent decay dynamics, and (4) identify complex reaction mechanisms involving polyatomic radical products, the crossed molecular beams technique is most suitable.<sup>6,7</sup>

Information derived from the measurements of angular and velocity distributions of reaction products played a crucial role in the advancement of our understanding of the dynamics of elementary chemical reactions. This and the more general investigations of chemical reactions under single collision conditions in crossed molecular beams will be the subject of this lecture.

Crossed Molecular Beams Experiments: Measurements of Angular and Velocity Distributions of Products.

If the motion of individual atoms were observable during reactive collisions between molecules, it would be possible to understand exactly how a chemical reaction takes place by just following the motion of these atoms. Unfortunately, despite recent advances in microscope technology that allow us to observe the static arrangement of atoms in a solid, we are still far from being able to follow the motion of atoms in the gas phase in real time. The idea of crossed molecular beams experiments is in a sense to "visualize" the details of a chemical reaction by tracing the trajectories of the reaction products. This is done by first defining the velocities, approach angle, and other initial conditions of the reactants, and then measuring the velocity and angular distributions of the products. For example, in the investigation of the  $F + D_2 \rightarrow DF + D$  reaction,<sup>8</sup> if we let F atoms and  $D_2$  molecules collide at a relative energy of 1.82 kcal/mol and then measure the angular and velocity distributions of DF products, we will obtain the results shown in Fig. 1. This contour map shows the probability of DF products appearing at specific angles and velocities and reveals a great deal about the dynamics of the reaction.  $0^\circ$  corresponds to the initial direction of the F atom beam and the distance between any point and the center is the center-of-mass velocity. The strong backward peaking of DF products with respect to the initial direction of F atoms indicates that not all the collisions between F atoms and  $D_2$  molecules produce DF

Fig. 1. Center-of-mass velocity flux contour map for the  $F + D_2 \rightarrow DF + D$  reaction. F atoms and  $D_2$  molecules move towards each other at a collision energy of 1.82 kcal/mol, with the F atoms moving from right to left.



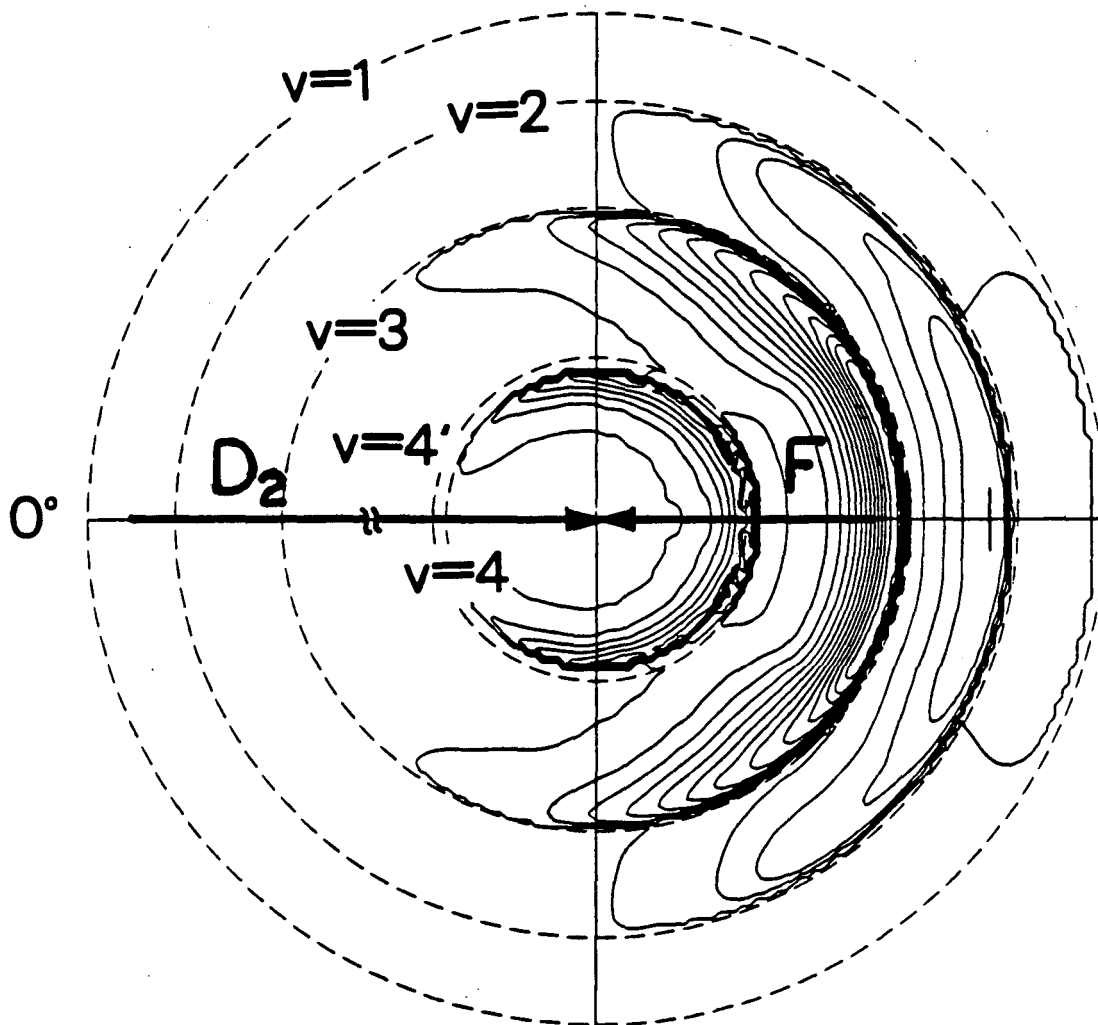
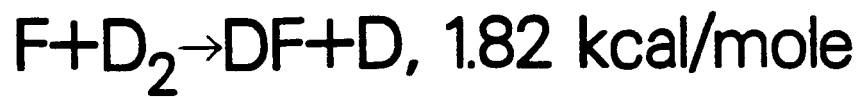

XBL 841-109

Fig. 1

product. Only those collisions in which the F atom and the two D atoms are nearly linear will react and produce DF. Apparently, if an F atom collides with a D<sub>2</sub> molecule from a direction perpendicular to the molecular axis of the D<sub>2</sub>, the F atom will only bounce off elastically. The appearance of DF in several velocity bands is due to the fact that DF molecules are produced in several vibrational states with different recoil velocities as indicated in the figure. Since the total energy released in every reactive encounter between F and D<sub>2</sub> is the same, the maximum energy available for translational motion will depend on the vibrational quantum state of DF. Because the rotational energy spread of DF products is less than the spacings of the vibrational energy levels; the recoil velocities of various vibrational states of DF products are well separated and can be identified easily.

If a crossed molecular beams study of the  $F + D_2 \rightarrow DF + D$  reaction is carried using the an experimental arrangement shown in Fig. 2, the rate of production of DF products,  $dN_{DF}/dt$ , in the scattering volume defined by the crossing of two beams can be estimated from the following equation:

$$\frac{dN_{DF}}{dt} = n_F n_{D_2} \sigma g \Delta V$$

where  $n_f$  and  $n_{D_2}$  are the number densities of F atoms and D<sub>2</sub> molecules in the scattering region,  $\sigma$ ,  $g$ , and  $\Delta V$  are the reaction cross section, the relative velocity between F and D<sub>2</sub> and the scattering volume, respectively. In a experiment using a velocity

Fig. 2. Experimental arrangement for  $F + D_2 \rightarrow DF + D$  and  $F + H_2 \rightarrow HF + H$  reactive scattering. Pressures (in torr) for each region are indicated. Components shown by numbers are: (1) effusive F atom beam source made of nickel, resistively heated; (2) velocity selector; (3) liquid nitrogen cooled cold trap; (4)  $D_2$  or  $H_2$  beam source, supersonic expansion, (5) heater, (6) liquid nitrogen feed line, (7) skimmer, (8) tuning fork chopper, (9) synchronous motor, (10) cross correlation chopper for time-of-flight velocity analysis, (11) ultrahigh vacuum, triply differentially pumped, mass spectrometric detector chamber.

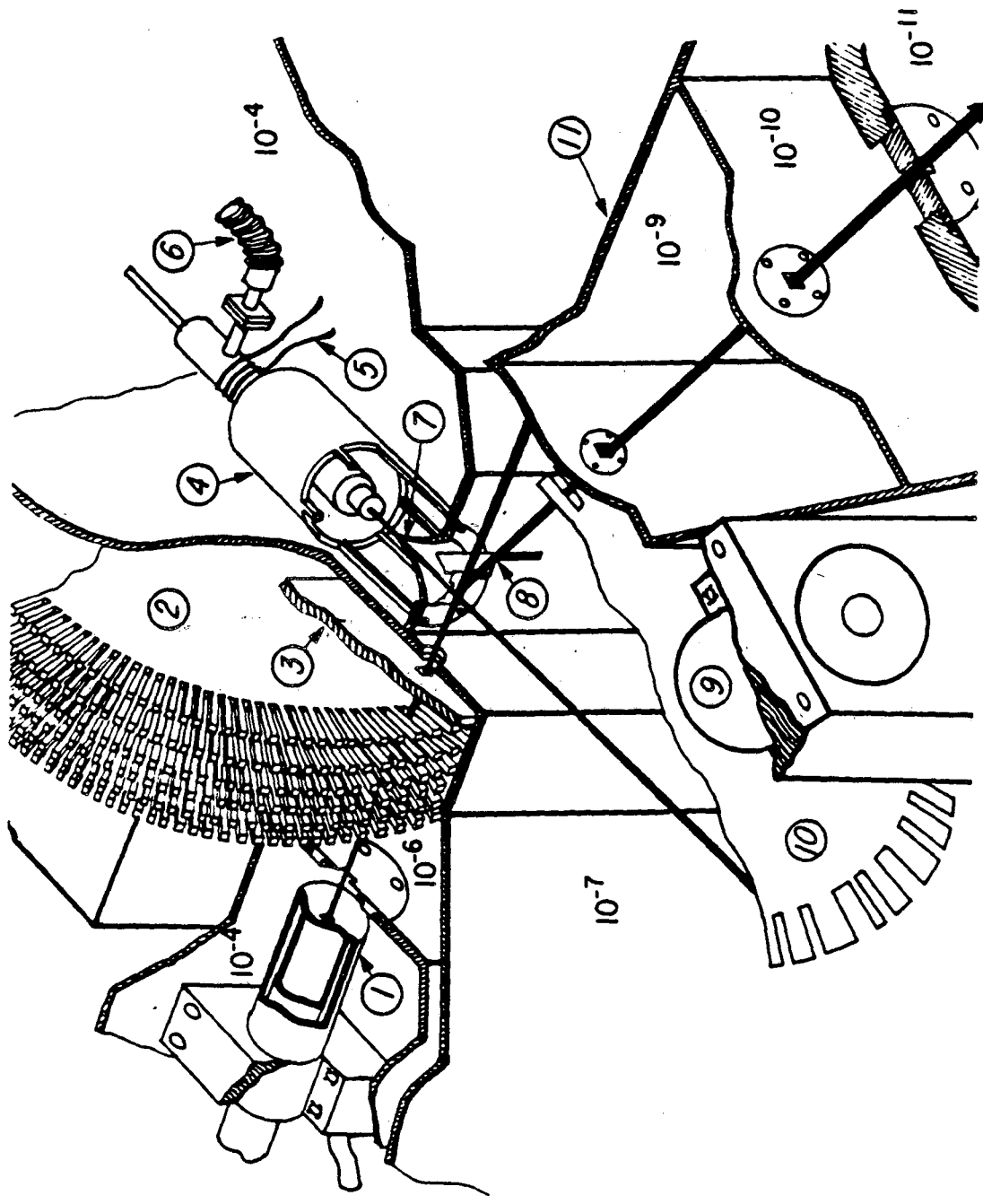

XBL 8511-4625

Fig. 2

selected effusive F atom source and a supersonic beam of  $D_2$ , the values of  $n_F$ ,  $n_{D_2}$ , and  $\Delta V$  are typically  $10^{10}$  molecules/cc,  $10^{12}$  molecules/cc, and  $10^{-2}$  cc. If the relative velocity between F and  $D_2$  is  $10^5$  cm/sec and the reactive cross section is  $10^{-15}$   $cm^2$ , then  $dN_{HF}/dt$  will have a value of  $10^{10}$  molecules/sec. These DF products with various recoil velocities will scatter into a range of laboratory angles. If the DF is scattered fairly evenly within 1 steradian of solid angle in the laboratory and if the movable detector which scans the angular distribution has an acceptance solid angle of  $1/3000$  steradian (approximately an angular width of  $1^\circ$  in both directions from the detector axis), the detector will receive  $\sim 3 \times 10^6$  DF molecules per second.

To detect the DF products, however, first it is necessary to ionize DF to  $DF^+$  by electron bombardment. The product ion can then be mass filtered and counted. The typical ionization efficiency for a molecule during the short transit time through the ionizer is about  $10^{-4}$ .  $3 \times 10^6$  DF/sec reaching the detector will yield only 300  $DF^+$  ions/sec. However, this is a large enough number to allow reliable measurements of angular and velocity distributions in a relatively short time if the background count rate is not much greater. Indeed, the success of a crossed molecular beams study of such a chemical reaction depends entirely on whether the background in the mass spectrometric detector can be reduced sufficiently.<sup>9</sup>

There are two sources of background molecules in the detector that one has to deal with in a crossed molecular beams experiment: the inherent background in the detector chamber and the background caused by the effusion of molecules from the collision chamber into the detector when the beams are on. The former is mainly due to outgassing from the materials used for the construction of the chamber and to limitations imposed by the performance of the ultrahigh vacuum pumping equipment. Reduction of the latter requires many stages of differential pumping using buffer chambers.

#### Direct Experimental Probing of Potential Energy Surfaces

For gaseous rare gas systems, if the interaction potentials between the atoms are accurately known, all bulk properties and transport phenomena can be predicted theoretically. Similarly, for a simple atom-molecule reaction, the potential energy surface, which describes the interaction potential as a function of the coordinates of the atoms, will be the basis for the understanding of the detailed dynamics of a chemical reaction.

One of the systems which has attracted extensive attention in both experimental and theoretical efforts during the last fifteen years is the reaction of  $F + H_2 \rightarrow HF + H$ . In the early 1970's, using quasi-classical trajectory calculations, Muckerman derived a semiempirical potential energy surface, known as the Muckerman V surface, which gave results in agreement with all experimental data available at that time.<sup>11</sup> These results included rate constants,

vibrational-rotational state distributions obtained from chemical laser and chemiluminescence experiments, as well as product angular distributions obtained from  $F + D_2 \rightarrow DF + D$  experiments as shown in Fig. 1. The potential energy surface obtained from the ab initio quantum mechanical calculations<sup>12</sup> was still rather limited at that time, but it did show many important features which were in good qualitative agreement with the Muckerman V surface.

If the Muckerman V surface were sufficiently accurate, it would be possible to carry out scattering calculations using this surface under conditions which could not be easily arranged in the laboratory. This would significantly expand the scope of our understanding of the dynamics of this system. However, the accuracy of the Muckerman V surface depends not only on the reliability of the experimental input used in the derivation of the surface, but also on the applicability of classical mechanics in treating the  $F + H_2 \rightarrow HF + H$  reaction. This is certainly a major concern for a H atom transfer reaction.

One dimensional quantum calculations on the  $F + H_2$  reaction, although not necessarily realistic, had in fact shown the inadequacy of classical mechanics in handling this reaction.<sup>13,14</sup> Quantum effects were, indeed, very important, and in all these calculations strong "resonances" were found in the dependence of reaction probability on collision energy.<sup>15</sup> These resonances were later shown to be due to the formation of "quasi-bound" states in the F-H-H reaction intermediate.<sup>16,17</sup> The  $F + H_2$  surface has a barrier in

the entrance channel, but there is no attractive well in the intimate region near the transition state. The quasi-bound states in the  $F + H_2$  reaction are entirely dynamical in nature. Loosely speaking, the first dynamic resonance is due to the formation of a bound state which is a superposition of  $F + H_2(v=0)$  and  $HF(v=3) + H$  in the intimate region of chemical interaction.

The discovery of dynamical resonances in the collinear quantal calculations of the  $F + H_2$  system provided new possibilities for probing the critical region of the potential energy surface more directly. In contrast to most other microscopic experiments, in which the influence of the potential energy surface on the final distribution of products is assessed, the experimental observation of resonances is almost equivalent to carrying out vibrational spectroscopy directly on the reaction intermediate. Thus it should offer a more stringent test of the details of the calculated potential energy surface.<sup>16</sup>

In a three dimensional quantum scattering calculation of  $F + H_2$  on the Muckerman V surface, Wyatt et al.<sup>18</sup> have shown that as the collision energy is increased beyond the one dimensional resonance energy, the resonance does not just disappear but occurs at increasingly larger impact parameters. Consequently, resonances cannot be observed in an experiment in which the reaction cross section is measured as a function of collision energy. On the other hand, if the experiment is carried out at a fixed collision energy, and if the reaction probability is measured as a function of impact parameter, the resonance should be observable. Unfortunately, one has



no hope of controlling or measuring the impact parameter in a scattering experiment. But, for  $F + H_2 \rightarrow HF + H$ , in which the collinear configuration dominates the reactive scattering at lower collision energies, the scattering angle of HF should depend on the impact parameter. In particular, when a quasi-bound state is formed, if the average lifetime of the F-H-H intermediate is an appreciable fraction of its rotational period, HF produced from the decay of the F-H-H quasi-bound state is expected to scatter in a more forward direction compared to the strongly backward peaked HF produced by direct reaction. One of the unique and most important aspects of the measurement of product angular distributions is that one can use the rotational period of the reaction intermediate, typically  $10^{-12}$ - $10^{-13}$  sec to judge the lifetime of the reaction intermediate.<sup>6</sup> If the average lifetime of the intermediate is much longer than the rotational period, the angular distribution of products will show forward-backward symmetry. On the other hand, if the lifetime is much shorter, the asymmetric angular distribution reveals the preferred molecular orientation for the chemical reaction to occur.

Experimental measurements of the laboratory angular distribution and time-of-flight velocity distributions of HF products at a collision energy of 1.84 kcal/mole, using the experimental arrangement shown in Fig. 2, are shown in Figs. 3 and 4. The velocity and angular distributions in the center-of-mass coordinate system derived from these experimental results are shown in Fig. 5.<sup>19</sup> The enhanced forward peaking in the angular distribution of HF in  $v=3$  is a strong

Fig. 3. Laboratory angular distribution for  $F + \text{para-H}_2$ , 1.84 kcal/mol, velocity diagram shown below. Both the data and calculated laboratory distributions are shown (. data, \_\_\_\_\_ total calculated, \_\_\_\_\_ v=1, \_\_\_\_\_ v=2, - - - - - v=3, \_\_\_\_\_ v=3' (from  $H_2(J=2)$ )).

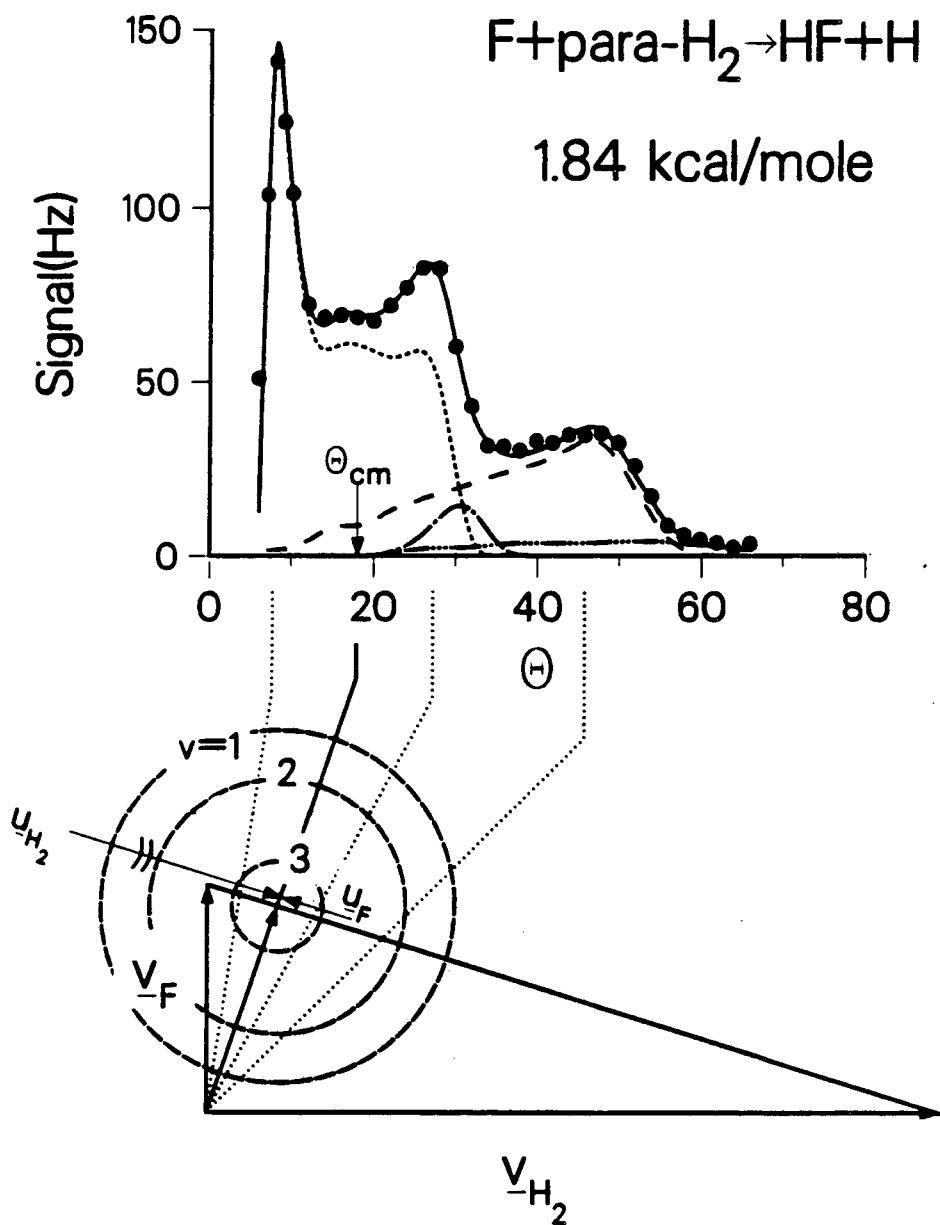

XBL 841-54

Fig. 3

Fig. 4. Time-of-flight spectra for F + para-H<sub>2</sub>, 1.84 kcal/mol.  
(Δ data, — total calculated, —...— v=1, — — — — v=2, - - - - -v=3, —...—v=3'.

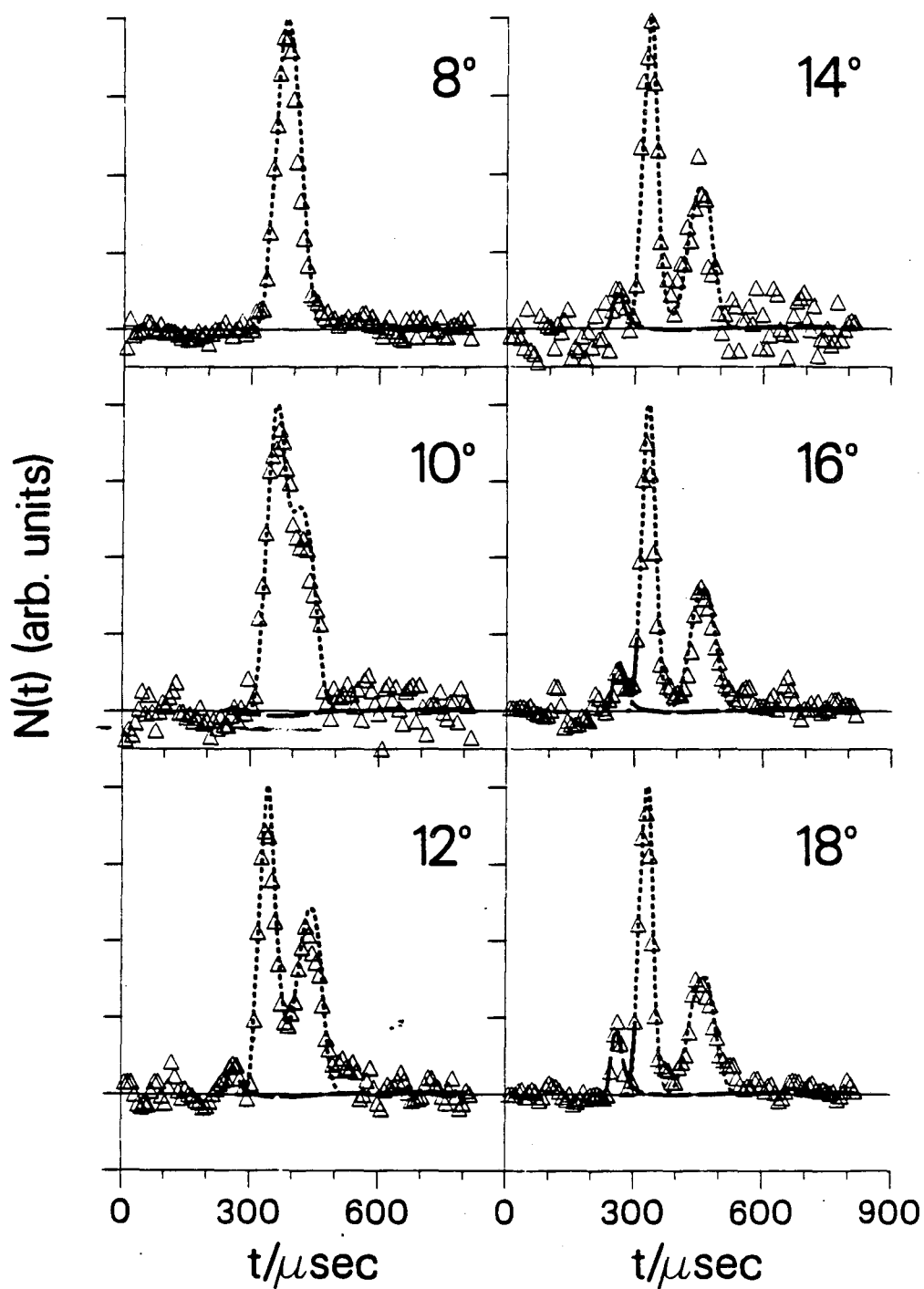
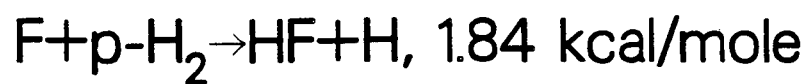

XBL 841-36

Fig. 4(a)

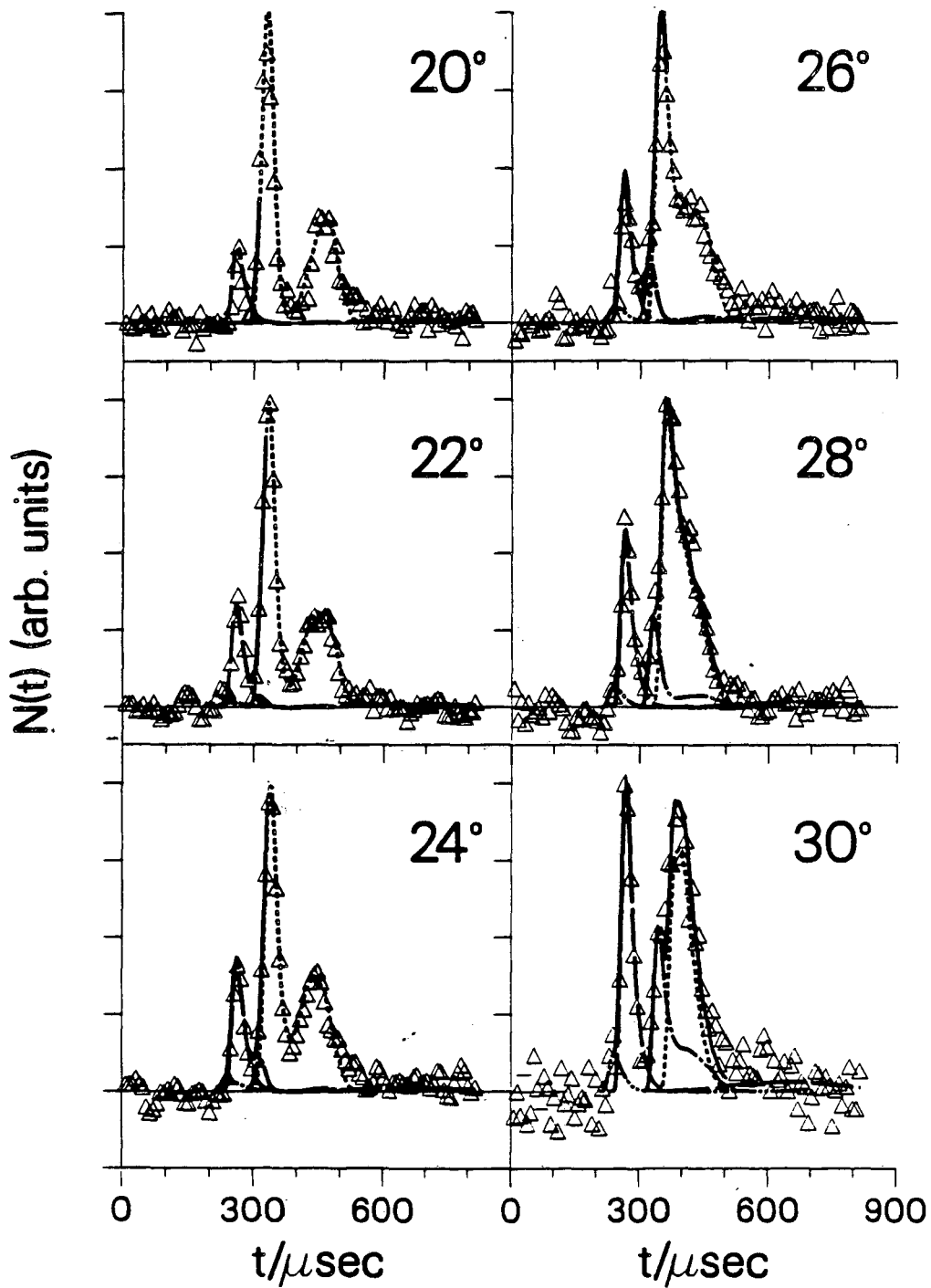
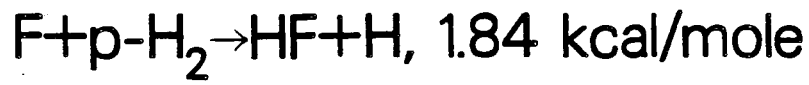

XBL 841-38

Fig. 4(b)

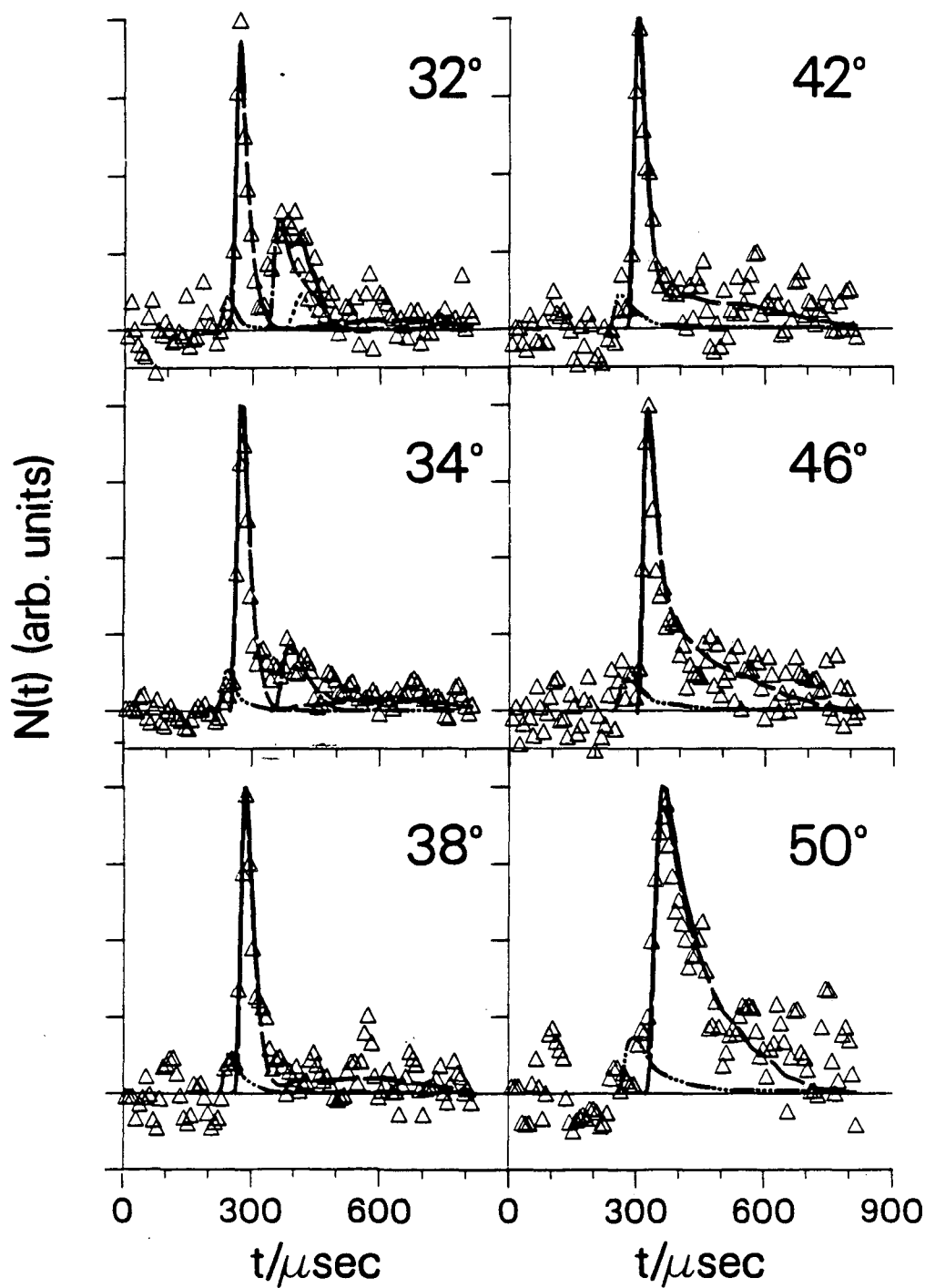
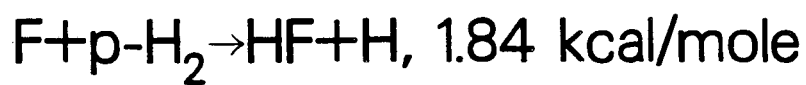

XBL 841-39

Fig. 4(c)

Fig. 5. Center-of-mass velocity flux contour map for  $F + \text{para-H}_2$ ,  
1.84 kcal/mol, shown in three-dimensional perspective.



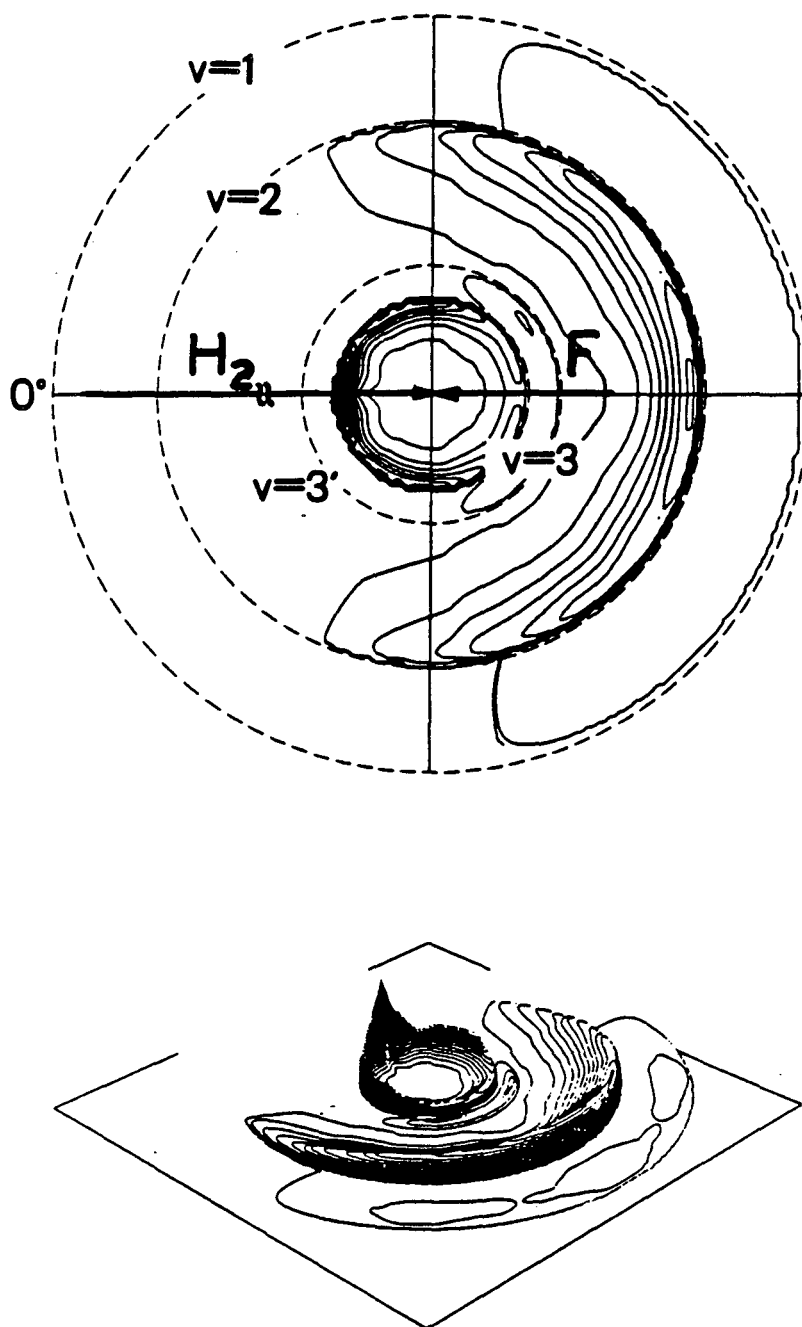
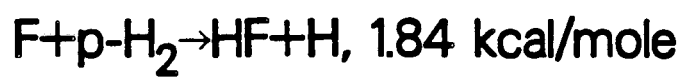

XBL 841-21A

Fig. 5

indication that quasi-bound states are indeed formed in the  $F + H_2 \rightarrow HF + H$  reaction at this energy, and that they seem to decay exclusively into HF in the  $v=3$  state rather than the  $v=2$  state.

This disagreement is certainly due to the shortcoming in the M5 surface. These vibrationally state specific angular distributions obtained at various collision energies for  $F + H_2$ , HD and  $D_2$  reactions provide a very stringent test for the ever improving potential energy surfaces obtained from ab initio quantum mechanical calculations.

#### EXPLORATION OF NEW CHEMISTRY UNDER SINGLE COLLISION CONDITIONS

There are many mysterious phenomena in nature which have thus far defied explanation. The mystery is often due to the fact that a certain phenomenon cannot be understood based on our established knowledge or common sense.

The ease with which  $F_2$  and  $I_2$  react to produce electronically excited IF molecules which relax through photon emission was a mystery a dozen years ago.<sup>20</sup> A molecule-molecule reaction is supposed to have a high energy barrier and the four-center reaction producing two IF molecules, with either both in the ground state or one of them in an excited state, is a symmetry forbidden process. The text book mechanism has either  $I_2$  or  $F_2$  molecules first dissociating into atoms followed by the radical chain reactions  $F + I_2 \rightarrow IF + I$  and

$I + F_2 \rightarrow IF + F$ . However, neither of these reactions is exothermic enough to produce electronically excited IF.

The clue that something new might be happening in this reaction was actually discovered in a crossed molecular beams study of the  $F + CH_3I \rightarrow IF + CH_3$  reaction.<sup>21</sup> When we found that this reaction proceeded through the formation of a long lived complex, we began to increase the collision energy to see whether it was possible to shorten the lifetime enough to make it comparable to the rotational period of the  $CH_3IF$  complex. If we could estimate the lifetime of the collision complex using the rotational period as a clock, it would be possible to evaluate the stability of this reaction intermediate using statistical theories for the unimolecular decomposition rate constants. At higher collision energies, the angular distribution of products monitored at  $m/e=146$  ( $IF^+$ ) showed a peculiar feature which could not possibly be due to IF produced from the  $F + CH_3I$  reaction. This was later shown to be from stable  $CH_3IF$  produced in the collision volume of the two beams which yielded additional  $IF^+$  signal after dissociative ionization.

The stable  $CH_3IF$  was in fact formed by the reaction of undissociated  $F_2$  in our F atom beam with  $CH_3I$ :

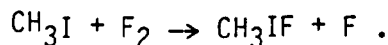

The threshold for this reaction was found to be 11 kcal/mol. Since the dissociation energy of  $F_2$  is 37 kcal/mole, the dissociation energy of  $CH_3IF \rightarrow CH_3I + F$  could be as high as 26 kcal/mol

(Fig. 6). This was certainly a surprising result and was entirely unsuspected.

In the reaction of  $I_2$  and  $F_2$ , it was not surprising that the stability of the  $I_2F$  radical is the driving force for the reaction

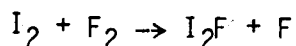

to proceed. But, what amazed us most was that this reaction had a threshold of only 4 kcal/mol, and that at 7 kcal/mol the reaction

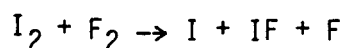

was observed.<sup>22</sup> The production of I and IF in this reaction is most likely through the secondary decomposition of vibrationally excited  $I_2F$  radicals. Later, a careful investigation showed that the threshold energy for producing electronically excited iodofluoride,  $IF^*$ ,<sup>23</sup>

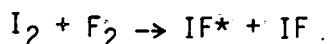

is identical to that for  $I_2F + F$  formation. However, the formation of electronically excited  $IF^*$  is only a minor channel compared to  $I_2F + F$  formation. Apparently, it is a secondary encounter between the departing F atom and the terminal I atom in  $I_2F$  which produces  $IF^*$ . A relatively rare sequential process during a binary collision between  $F_2$  and  $I_2$  is responsible for the production of electronically excited IF, not the symmetry forbidden four-center reaction which breaks and forms two bonds simultaneously.

The fact that one can control kinetic energy precisely and carry out a synthetic study of delicate new radicals through endothermic

Fig. 6. Energy diagram showing the relative energy  $\text{CH}_3\text{IF}$  intermediate in the reaction of  $\text{F} + \text{CH}_3\text{I} \rightarrow \text{CH}_3 + \text{IF}$  and as a product of the endothermic  $\text{F}_2 + \text{CH}_3\text{I} \rightarrow \text{CH}_3\text{IF} + \text{F}$  reaction.

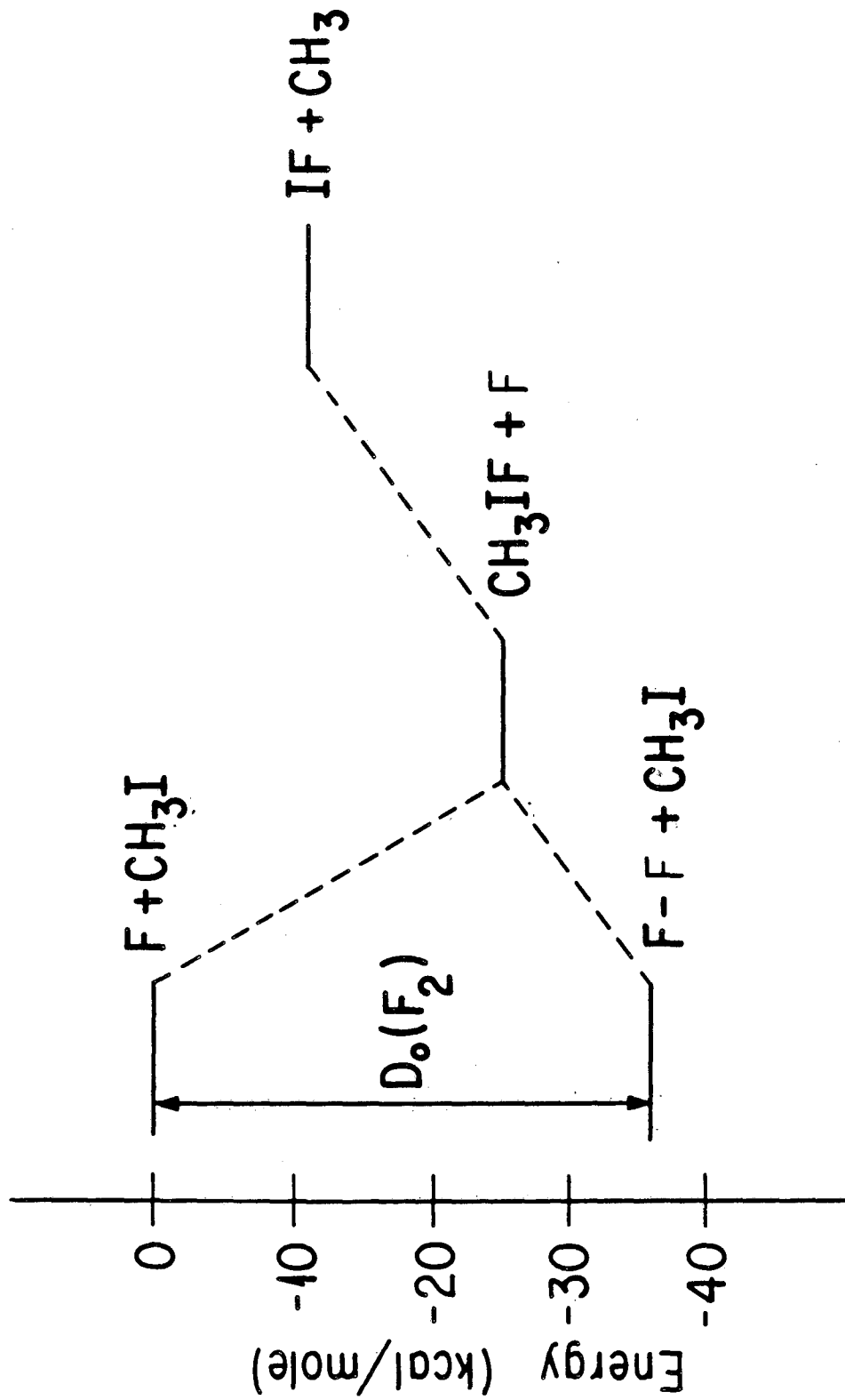

XBL 8611-4698

FIG. 6

reactions is certainly among the most dramatic features of crossed molecular beams experiments.

The development of the seeded supersonic beam source has been largely responsible for making crossed molecular beams experiments at higher collision energies possible.<sup>24</sup> If a gaseous mixture is expanded into a vacuum chamber through a small nozzle with a sufficiently high stagnation pressure, all molecules, regardless of their molecular weights, attain the same average terminal speed. Consequently, the kinetic energies of molecules in the beam will be proportional to their molecular weights, and for heavier atoms or molecules a very high kinetic energy can be obtained by seeding a small fraction of heavy particles in a very light carrier gas.

In a recent series of investigations of substantially endothermic reactions of Br atoms with ortho-, meta- and para-chlorotoluenes, a beam of energetic Br atoms was used to study the reactivity and dynamics of Cl atom substitution by Br atoms.<sup>25</sup> The intermediates of these reactions are expected to have potential wells which are much shallower than the endothermicity of reaction. From the measurements of the translational energy dependence of the reaction cross sections and the product translational energy distributions, the extent of energy randomization among various vibrational degrees of freedom was found to be rather limited. Despite the fact that ortho- and para-chlorotoluenes react easily, no substitution was observed for meta-chlorotoluene indicating that the electron density distribution on the benzene ring strongly influences the reactivity, even though

dynamic factors are expected to be more important in endothermic substitution reactions.

Elucidation of Reaction Mechanisms from Product Angular and Velocity Distributions.

In elementary chemical reactions involving complicated polyatomic molecules, the unravelling of the reaction mechanism is often the most important issue. Without the positive identification of primary products, it is not possible to discuss reaction dynamics in a meaningful way. In bulk experiments, the identification of primary products has often been complicated by fast secondary reactions of primary products. Recently, advances in sensitive detection methods and time resolved laser techniques have allowed single collision experiments to become possible even in the bulk, and complications caused by secondary collisions can be avoided. However, the positive identification of internally excited polyatomic radicals produced under single collision conditions is still a very difficult problem. Spectroscopic techniques which are so powerful in providing state resolved detection of atoms or diatomic molecules are often not very useful, either because of the lack of spectroscopic information or simply because huge numbers of states are involved. The more general mass spectrometric technique, which depends heavily on "fingerprints" of fragment ions for positive identification, also suffers from the fact that fragmentation patterns for vibrationally excited polyatomic radical products in electron bombardment ionization are not known.



This problem is especially serious because many radicals do not yield parent ions. Even if stable molecules are formed as products, the change in fragmentation patterns with increasing internal energy can be so drastic that erroneous conclusions are often reached. For example, at room temperature both ethanol ( $C_2H_5OH$ ) and acetaldehyde ( $CH_3CHO$ ) will yield  $C_2H_5OH^+$  and  $CH_3CHO^+$  as major ions by electron bombardment ionization. However, since both these ions contain a very weak bond and most of the vibrational energy is retained in the ionization process, when highly vibrationally excited  $C_2H_5OH$  and  $CH_3CHO$  are ionized, even if parent ions are initially produced, they will further dissociate into  $C_2H_5O^+$  and  $CH_3CO^+$  by ejecting an H atom.<sup>26</sup>

The problem of product identification caused by the fragmentation of primary products during the ionization process can be overcome if product angular and velocity distributions are measured carefully in high resolution crossed molecular beams experiments. For example, the reaction between  $O(^3P)$  and  $C_2H_4$  under single collision conditions using a mass spectrometer to detect the products generates signal at  $m/e=43,42,29,27$ , and 15. The fact that  $m/e=15$  ( $CH_3^+$ ) and 29 ( $HCO^+$ ) are the most intense signals suggests that  $CH_3 + HCO$  is the major reaction channel. This conclusion is in agreement with previous studies of the reaction of

$O(^3P)$  with  $C_2H_4$  carried out by Cvetanovic,<sup>27</sup> Pruss et al.,<sup>28</sup> and Blumenberg et al.<sup>29</sup> From the analysis of final products in a bulk experiment using photoionization detection of products with hydrogen Lyman- $\alpha$  (10.2 eV) radiation and electron bombardment ionization mass spectrometry, it was concluded that formation of  $CH_3$  and  $HCO$ , resulting from 1,2 migration of a hydrogen atom in the reaction intermediate and subsequent C-C rupture, as shown below, provides 90 percent of the products.

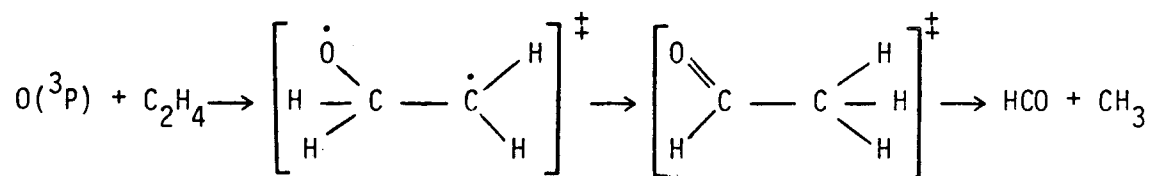

The remaining, 10 percent is ketene formed by a three center elimination of an  $H_2$  molecule from the reaction intermediate.

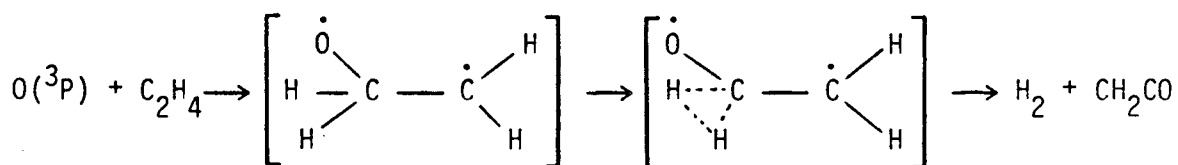

The measurements of product angular distributions in a crossed molecular beams experiment,<sup>30</sup> as shown in Fig. 7, gave strong evidence that the above conclusion was not quite correct. The fact that the intense  $m/e=42$  signal and the weak  $m/e=43$  signal (not shown) have the same angular distributions indicates that the substitution reaction forming vinyloxy radical,  $CH_2CHO + H$ , occurs. The  $m/e=42$  signal ( $C_2H_2O^+$ ) results from dissociative ionization of  $CH_2CHO$  product rather than from the formation of  $CH_2CO$  and  $H_2$ . The

Fig. 7. Angular distributions from the reaction  $O + C_2H_4$  at 10.7 kcal/mol collision energy. (A)  $CH_2CHO$  product, (B) elastic scattering of  $C_2H_4$  monitored at  $m/e=27$  ( $C_2H_3^+$ ), (C)  $m/e=15$  ( $CH_3^+$ ), contributions from  $C_2H_4$  and  $CH_2CHO$  are indicated by x and o respectively.

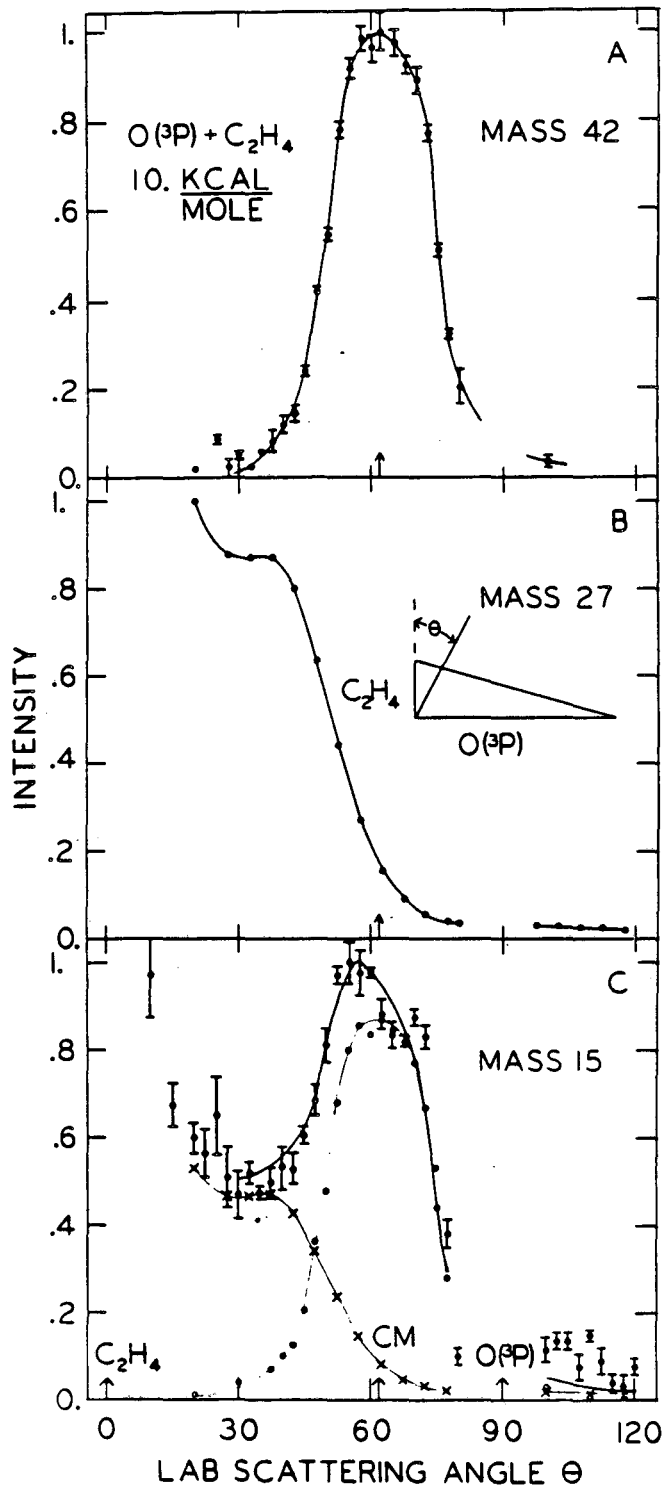

XBL 815-9971

Fig. 7

formation of  $\text{CH}_2\text{CO}$  through the three center elimination of a hydrogen molecule is expected to release a larger amount of recoil energy and the fact that  $\text{CH}_2\text{CO}$  is recoiling from  $\text{H}_2$  rather than from an H atom will cause the laboratory angular distribution of  $\text{CH}_2\text{CO}$  to be much broader than that of  $\text{CH}_2\text{CHO}$ . The  $m/e=15$  ( $\text{CH}_3^+$ ) angular distribution clearly shows that in addition to reaction products, elastically scattered  $\text{C}_2\text{H}_4$  molecules also produce  $\text{CH}_3^+$  ions during ionization. The angular distribution of scattered  $\text{C}_2\text{H}_4$  can be unambiguously measured at  $m/e=27$  ( $\text{C}_2\text{H}_3^+$ ). After subtracting the contribution from elastically scattered  $\text{C}_2\text{H}_4$  from the angular distribution at  $m/e=15$ , it is quite clear that the residual angular distribution of reactively scattered  $\text{CH}_3^+$  has an identical angular distribution to that measured at  $m/e$  43 and 42. Apparently, most of the  $\text{CH}_3^+$  from reactive scattering are also daughter ions of vinyloxy radicals,  $\text{CH}_2\text{CHO}$ . If the product channel  $\text{CH}_3 + \text{HCO}$  were dominant the angular distribution of  $\text{CH}_3^+$  would be much broader. Without the measurement of product angular or velocity distributions which reveal the parent-daughter relations one would not have suspected that the simple substitution reaction forming vinyloxy radical

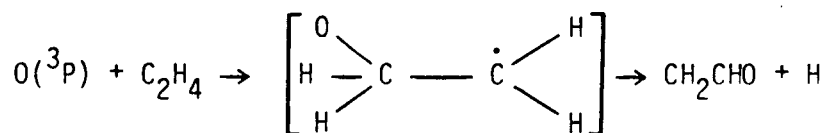

is in fact the major channel.

This was certainly a shocking discovery to chemical kineticists, since the reaction mechanism,  $O(^3P) + C_2H_4 \rightarrow CH_3 + HCO$ , was thought to be well established. The important role played by the  $CH_2CHO + H$  channel was never suspected. Several recent bulk studies using various time resolved spectroscopic techniques<sup>31-35</sup> have verified the major role played by the hydrogen substitution channel indicated by the crossed molecular beams experiments. These were not strictly single collision experiments, but all showed that the reaction channel  $CH_2CHO + H$  accounted for at least half of the products.

#### CONCLUDING REMARKS

The experimental investigation of elementary chemical reactions is presently in a very exciting period. The advancement in modern microscopic experimental methods, especially crossed molecular beams and laser technology, has made it possible to explore the dynamics and mechanisms of important elementary chemical reactions in great detail. Through the continued accumulation of detailed and reliable knowledge about elementary reactions, we will be in a better position to understand, predict and control many time-dependent macroscopic chemical processes which are important in nature or to human society.

In addition, because of recent improvements in the accuracy of theoretical predictions based on large scale ab initio quantum mechanical calculations, meaningful comparisons between theoretical and experimental findings have become possible. In the remaining

years of the twentieth century, there is no doubt that the experimental investigation of the dynamics and mechanisms of elementary chemical reactions will play a very important role in bridging the gap between the basic laws of mechanics and the real world of chemistry.

The experimental investigations described in this article would not have been possible without the dedicated efforts of my brilliant and enthusiastic coworkers during the past twenty years. I enjoyed working with them immensely and sharing the excitement of carrying out research together.

Throughout all these years, my scientific research activities have been supported continuously by the Director, Office of Energy Research, Office of Basic Energy Sciences, Chemical Sciences Division of the U.S. Department of Energy (Contract No. DE-AC03-76SF00098) and the Office of Naval Research (Contract No. N00014-83-K-0069). The stable and continuing support and the confidence they have shown in my research have been most important and are gratefully appreciated.

REFERENCES

1. H. Eyring and M. Polanyi, *Z. Phys. Chem.* B12 (1931) 279.
2. J. C. Polanyi and D. C. Tardy, *J. Chem. Phys.* 51 (1969) 5717.
3. J. H. Parker and G. C. Pimentel, *J. Chem. Phys.* 51 (1969) 91.
4. H. W. Cruse, P. J. Dagdigian, and R. N. Zare, *Faraday Discussion of the Chemical Society*, 55 (1973) p.277.
5. D. P. Gerrity and J. J. Valentini, *J. Chem. Phys.* 82 (1985) 1323.
6. D. R. Herschbach, in Les Prix Nobel 1985, Nobel Foundation, 1987.
7. R. B. Bernstein, Chemical Dynamics via Molecular Beam and Laser Techniques, Oxford University Press, 1982.
8. D. M. Neumark, A. M. Wodtke, G. N. Robinson, C. C. Hayden, K. Shobatake, R. K. Sparks, T. P. Schaefer, and Y. T. Lee, *J. Chem. Phys.* 82 (1985) 3067.
9. Y. T. Lee, in Atomic and Molecular Beam Method, edited by G. Scoles and U. Buck, Oxford University Press, 1986.
10. Y. T. Lee, J. D. McDonald, P. R. LeBreton, and D. R. Herschbach, *Rev. Sci. Instr.* 40 (1969) 1402.
11. J. T. Muckerman, in Theoretical Chemistry - Advances and Perspectives, edited by H. Eyring and D. Henderson (Academic Press, New York, 1981), Vol. 6A, 1-77.
12. C. F. Bender, P. K. Pearson, S. V. O'Neill, and H. F. Schaefer, *J. Chem. Phys.* 56 (1972) 4626; *Science*, 176 (1972) 1412.
13. D. G. Truhlar and A. Kuppermann, *J. Chem. Phys.* 52 (1970) 384; 56 (1972) 2232.
14. S.-F. Wu and R. D. Levine, *Mol. Phys.* 22 (1971) 991.



15. G. C. Schatz, J. M. Bowman, and A. Kuppermann, *J. Chem. Phys.* 63 (1975) 674.
16. A. Kuppermann, in Potential Energy Surfaces and Dynamics Calculations, edited by D. G. Truhlar (Plenum Publishing Corporation, New York, 1981).
17. J. M. Launay and M. LeDourneuf, *J. Phys.* B15 (1982) L455.
18. R. E. Wyatt, J. F. McNutt, and M. J. Redmon, *Ber. Bunsenges. Phys. Chem.* 86 (1982) 437.
19. D. M. Neumark, A. M. Wodtke, G. N. Robinson, C. C. Hayden, and Y. T. Lee, *J. Chem. Phys.* 82 (1985) 3045.
20. J. W. Birks, S. D. Gabelnick, and H. S. Johnston, *J. Mol. Spectr.* 57 (1975) 23.
21. J. M. Farrar, *J. Chem. Phys.* 63 (1975) 3639.
22. M. J. Coggiola, J. J. Valentini, and Y. T. Lee, *Int. J. Chem. Kin.* 8 (1976) 605.
23. C. C. Kahler and Y. T. Lee, *J. Chem. Phys.* 73 (1980) 5122.
24. R. P. Andres, J. B. Fenn, and D. R. Miller, Rarefied Gas Dynamics, Fifth Symposium, 1317-1336 (1967).
25. G. N. Robinson, R. E. Continetti, and Y. T. Lee, to be published *Faraday Disc. Chem. Soc.* 84 (1987).
26. F. Huisken, D. Krajnovich, Z. Zhang, Y. R. Shen, and Y. T. Lee, *J. Chem. Phys.* 78, 3806 (1983).
27. R. J. Cvetanovic, *Can. J. Chem.* 33 (1955) 1684.
28. F. J. Pruss, J. R. Slagle, and D. Gutman, *J. Phys. Chem.* 78 (1974) 663.

29. B. Blumenberg, K. Hoyerman and R. Sievert, Proc. 16th Int. Symp. on Combution, The Combustion Institute, 1977, p.841.
30. R. J. Buss, R. J. Baseman, G. He, and Y. T. Lee, J. Photochem. 17 (1981) 389.
31. G. Inoue and H. Akimoto, J. Chem. Phys. 74 (1981) 425.
32. H. E. Hunziker, H. Knepe, and H. R. Wendt, J. Photochem. 17 (1981) 377.
33. F. Temps and H. G. Wagner, Max Planck Inst. Stromungsforsch. Ber. 18 (1982).
34. U. C. Sridharan and F. Kaufman, Chem. Phys. Lett. 102 (1983) 45.
35. Y. Endo, S. Tsuchiya, C. Yamada, and E. Hirota, J. Chem. Phys. 85, 1986) 4446.

This report was done with support from the Department of Energy. Any conclusions or opinions expressed in this report represent solely those of the author(s) and not necessarily those of The Regents of the University of California, the Lawrence Berkeley Laboratory or the Department of Energy.

Reference to a company or product name does not imply approval or recommendation of the product by the University of California or the U.S. Department of Energy to the exclusion of others that may be suitable.

*LAWRENCE BERKELEY LABORATORY  
TECHNICAL INFORMATION DEPARTMENT  
UNIVERSITY OF CALIFORNIA  
BERKELEY, CALIFORNIA 94720*