

# Lawrence Berkeley National Laboratory

## LBL Publications

### Title

Progress in the Development of BSCCO-2212 Superconductors

### Permalink

<https://escholarship.org/uc/item/4396w67j>

### Authors

Walker, M S

Dietderich, D R

### Publication Date

1992-11-01



# Lawrence Berkeley Laboratory

UNIVERSITY OF CALIFORNIA

## Accelerator & Fusion Research Division

Presented at the High  $T_c$  Superconducting Workshop,  
Tsukuba, Japan, November 9-10, 1992, and to be  
published in the Proceedings

### Progress in the Development of BSCCO-2212 Superconductors

M.S. Walker and D.R. Dieterich

November 1992

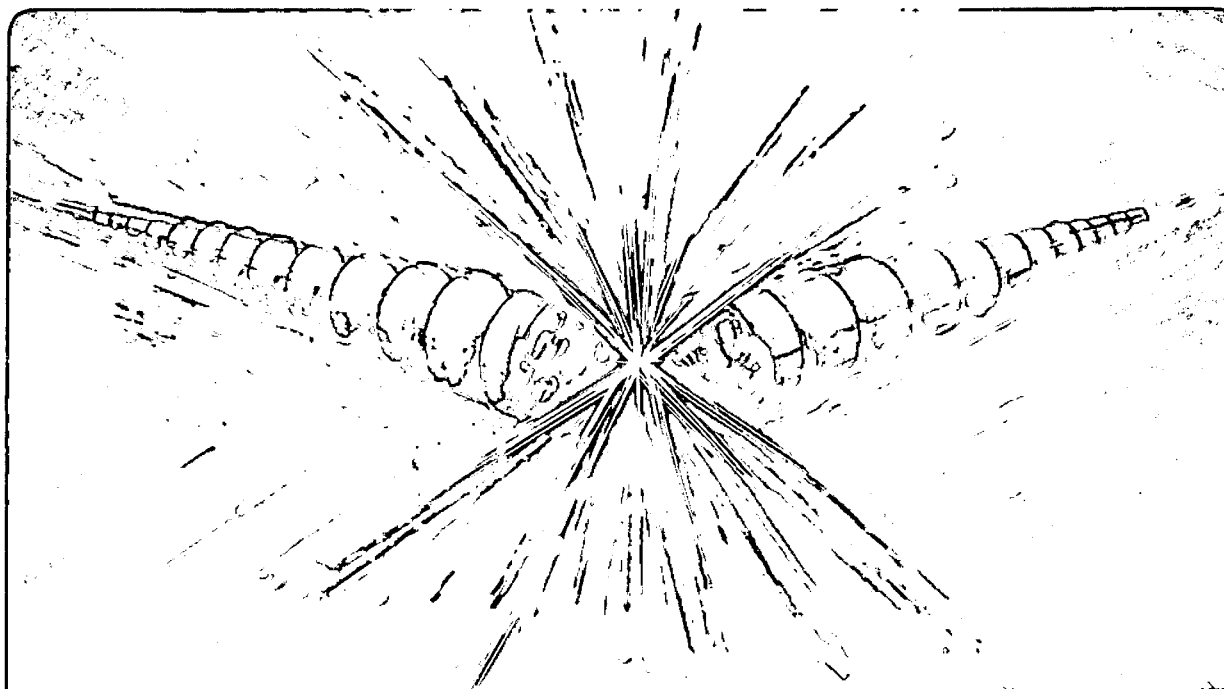

Prepared for the U.S. Department of Energy under Contract Number DE-AC03-76SF00098

LOAN COPY |  
Circulates |  
for 4 weeks |  
Bldg. 50 Library.

LBL-34662

Copy 2

## **DISCLAIMER**

This document was prepared as an account of work sponsored by the United States Government. While this document is believed to contain correct information, neither the United States Government nor any agency thereof, nor the Regents of the University of California, nor any of their employees, makes any warranty, express or implied, or assumes any legal responsibility for the accuracy, completeness, or usefulness of any information, apparatus, product, or process disclosed, or represents that its use would not infringe privately owned rights. Reference herein to any specific commercial product, process, or service by its trade name, trademark, manufacturer, or otherwise, does not necessarily constitute or imply its endorsement, recommendation, or favoring by the United States Government or any agency thereof, or the Regents of the University of California. The views and opinions of authors expressed herein do not necessarily state or reflect those of the United States Government or any agency thereof or the Regents of the University of California.

**SC-MAG-436  
LBL-34662**

# **Progress in the Development of BSCCO-2212 Superconductors\***

**M. S. Walker**

**(Visiting Scientist, Lawrence Berkeley Laboratory)  
Intermagetics General Corporation  
Guilderland, New York**

**D. R. Dietderich**

**Lawrence Berkeley Laboratory  
University of California  
Berkeley, California**

**November, 1992**

---

\* This was supported by the Director, Office of Energy Research, Office of High Energy and Nuclear Physics, High Energy Physics Division, U. S. Department of Energy, under Contract No. DE-AC03-76SF00098.

## PROGRESS IN THE DEVELOPMENT OF BSCCO-2212 SUPERCONDUCTORS

M. S. Walker\*

Intermagnetics General Corporation, Guilderland, New York

D. R. Dietderich

Lawrence Berkeley Laboratory, Berkeley, California

**ABSTRACT** - BSCCO-2212 powders were uniformly dip coated on silver ribbons of 1 meter lengths. Short sample sandwiches of various combinations of silver and the dip coated ribbon were reacted to form possible conductor geometries for characterization and testing. Optical and Scanning Electron Microscope (SEM) examination of surfaces and cross sections showed good but still not ideal microstructures. Representative critical current densities at 6 T and 4.2 K ranged from  $8 \times 10^3 \text{A/cm}^2$  for sandwich samples to  $2 \times 10^4 \text{A/cm}^2$  for open-faced samples.

### INTRODUCTION

Due to their high upper critical fields, Bi-based high- $T_c$  superconductors are promising candidates for use in high magnetic fields at low temperature. The potential candidates include conductors based on the  $\text{Bi}_2\text{Sr}_2\text{Ca}_1\text{Cu}_2\text{O}_8$  (BSCCO-2212) or the  $\text{Bi}_2\text{Sr}_2\text{Ca}_2\text{Cu}_3\text{O}_{10}$  (BSCCO-2223) compounds. There are several wire or tape manufacturing methods currently being pursued by various companies and research laboratories. Vacuumschmelze, Furukawa and Westinghouse both have active programs aimed at the development of Ag-sheathed tapes via a powder in a tube method based on the BSCCO-2212 compound.<sup>1,3</sup> Asahi Glass Company in collaboration with the National Research Institute for Metals (NRIM), SUNY Buffalo have been producing tapes of the BSCCO-2212 by the doctor-blade process.<sup>4,7</sup> Recently, Asahi, NRIM and Hitachi Cable have developed a dip-coating method to produce long lengths of conductor which have been wound into coils.<sup>8</sup> The recent critical current density ( $J_c$ ) achievements of these groups are greater than  $1000 \text{A/mm}^2$  can be

\*(Visiting Scientist with Lawrence Berkeley Laboratory at time of report)

obtained for fields greater than 20T at 4.2K. The results also show that the highest critical currents are obtained from material with the best grain alignment, i.e. textured microstructure. For low temperature application (1.8 K or 4.2 K) the BSCCO-2212 tapes seems to be as good as and may be superior to the BSCCO-2223 tapes.

It has been found that the BSCCO-2223 phase can be aligned by thermo-mechanical methods, such as rolling and sintering. However, a deformation-and-sintering schedule does not produce an aligned BSCCO-2212 microstructure. Aligned structures are only obtained by methods that have come to be called "melt growth" or "partial melt growth" processes.<sup>5</sup> These processes, as their names imply, melt part or all of the 2212 phase, which during cooling reverts to the 2212 phase in such a way as to produce an aligned structure. However, this reaction is not simple; the 2212 phase transforms to a liquid and at least three solid phases which undergo the reverse transformation to the 2212 phase on cooling as well as the loss of Bi due to the long time at high temperature.<sup>9</sup>

Of the several fabrication methods to produce long lengths of BSCCO-2212 we have adopted the dip-coating approach. Preliminary results for various tape geometries and atmospheres to control both differential thermal strain between the Ag and 2212 and Bi loss are reported as well.

## CONDUCTOR FABRICATION

The conductor samples were fabricated by dip-coating silver ribbons with a BSCCO-2212 powder slurry, variously hanging short samples of the coated ribbons or sandwiching them between comparable additional lengths of silver on alumina platforms, baking out the organic substances, and reacting to form conductor. To prepare the slurry a nominally 99.9+% pure commercial BSCCO-2212 powder from the SSC Corporation was mixed by milling with trichloroethylene as a carrier fluid, sorbitan trioleate as a dispersant and polyvinyl butyral as a binder. The 2212 particles used were platelets approximately 2-3  $\mu\text{m}$  in length or width and 0.3  $\mu\text{m}$  in thickness, as determined by SEM examination of the green or baked conductors (described later in this section).

Silver ribbons over a 1 meter long, approximately 60  $\mu\text{m}$  thick and approximately 5 mm wide were first cleaned in trichloroethylene and then dipped through the slurry using the arrangement shown schematically in Figure 1. Strongly adherent, uniform air-dried powder coatings thus obtained ranged in thickness from approximately 50  $\mu\text{m}$  to over 150  $\mu\text{m}$  per side, depending upon the starting viscosity of the fluid and rate of travel of the ribbon through the slurry. Figure 2 shows pieces from 1 meter lengths, of wider green dip-coated ribbons prepared in a similar way.

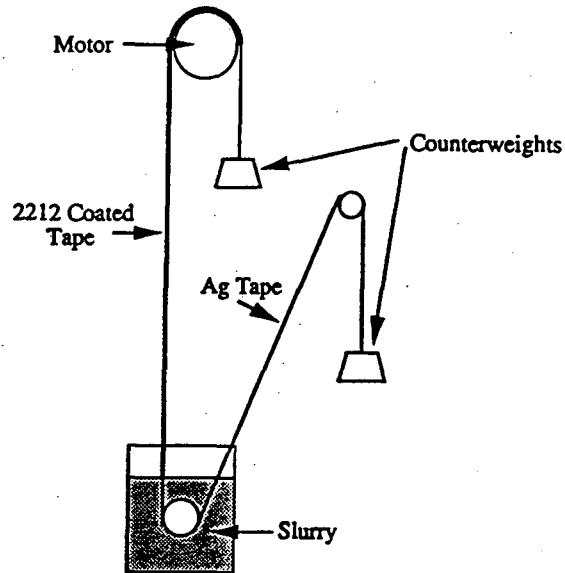

Figure 1 - Schematic of arrangement for dip-coating silver ribbons with a slurry containing BSCCO-2212 powders.

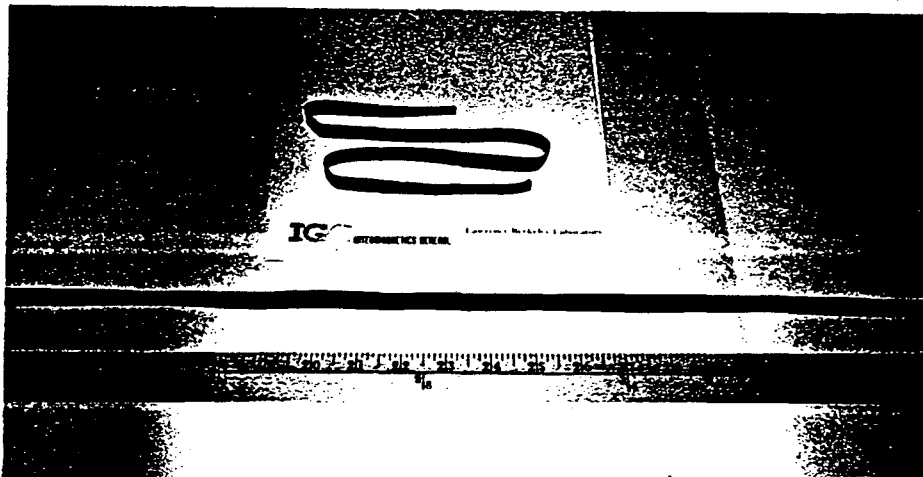

Figure 2 - Pieces from 1 meter lengths of green dip coated 13 mm wide BSCCO-2212 and silver ribbons.

Samples approximately 3 cm long were cut from the ribbons and formed into different conductor constructions and geometries, as shown in Figure 3, by either hanging them free of other contacts or placing them horizontally on silver strips to form open face or closed sandwiches under light alumina weights for reaction in air only or also in the presence of a source of bismuth vapor, as shown schematically in Figure 4. All samples were given the heat treatments shown in Figure 5. These consisted of (a) a bake out of organics at 500°C followed by, (b) partial melting at 883°C or 878°C and (c) slow cool through the 2212 formation region to 836°C.

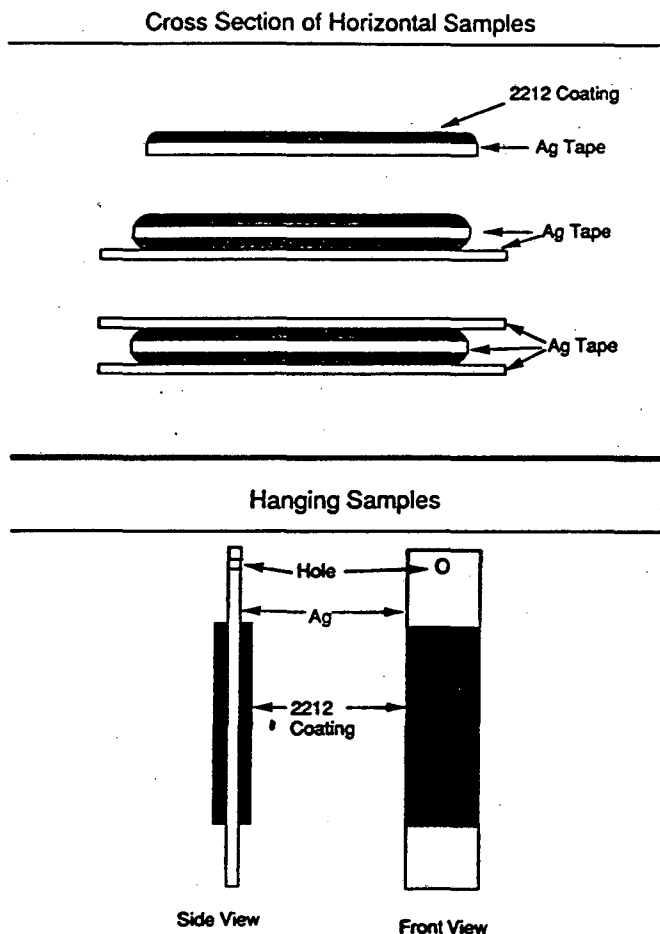

Figure 3 - Conductor sample geometries.

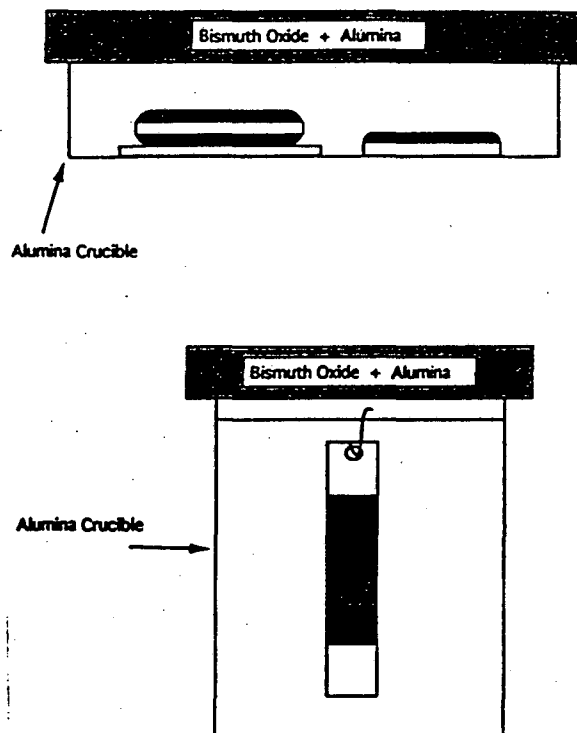

Figure 4 - Arrangements for Bi and air atmosphere.

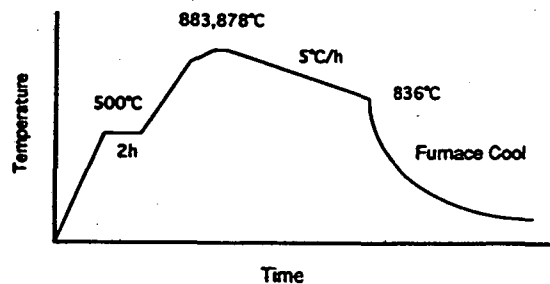

Figure 5 - Reaction time and temperature profiles used in the preparation of all samples.



## MICROSTRUCTURE

SEM micrographs, such as that shown in Figure 6, of cracked cross sections of the green or baked-out (but not reacted) oxide layers show a relatively porous nearly uniform coating of apparently randomly orientated platelet particles. After melt processing with the heat treatment schedule given above a dense partially aligned 2212 microstructure is produced. The cross-section of a tape, Figure 7, shows that there is grain alignment near the surface and 2212/Ag interfaces, but not throughout the entire oxide thickness.

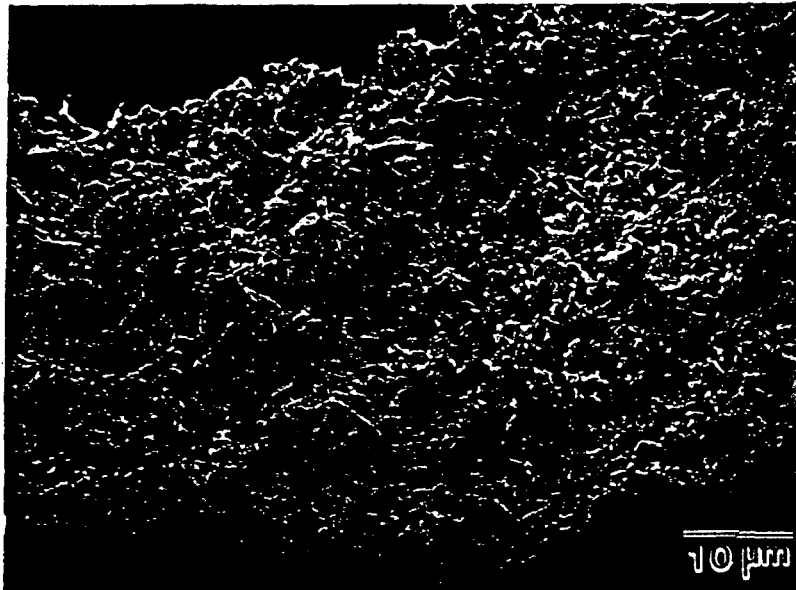

Figure 6 - Typical SEM micrograph of the cracked cross section of green or baked-out BSCCO-2212 dip coated ribbon.

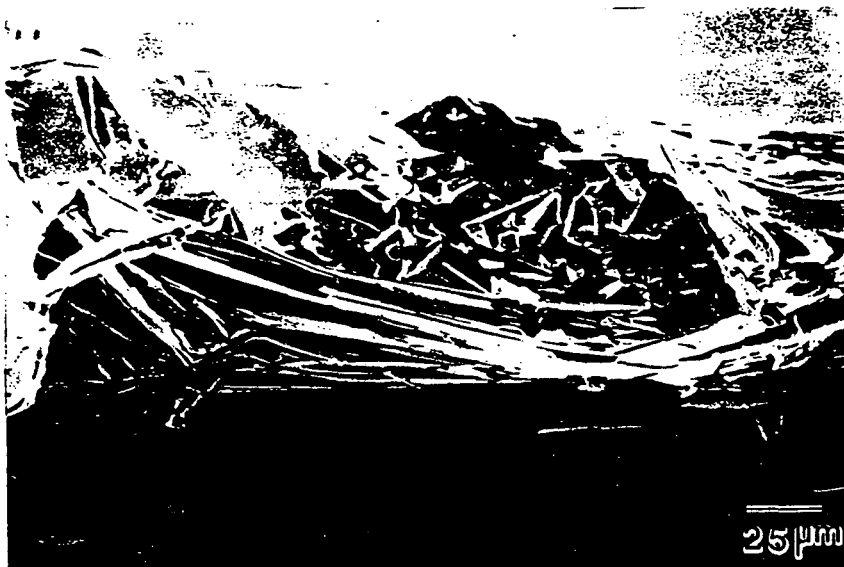

Figure 7 - Typical SEM micrograph of the cracked cross section of reacted BSCCO-2212 dip coated ribbon.

## CRITICAL CURRENTS

Transport critical currents were measured using a standard four point method with Pb-In-Ag soldered current and voltage contacts. Open faced sandwiches and hanging samples were additionally supported by gluing onto brass strip backing plates before soldering. Figure 8 shows transport critical currents along the conductor long axis for the various sample geometries, at 4.2 K in fields transverse to the current and parallel to the flat surface of the ribbons. Corresponding critical current densities in the oxide layers ranged from  $8 \times 10^3 \text{ A/cm}^2$  for sandwich samples to  $2 \times 10^4 \text{ A/cm}^2$  for open-faced samples, as shown in Figure 9.

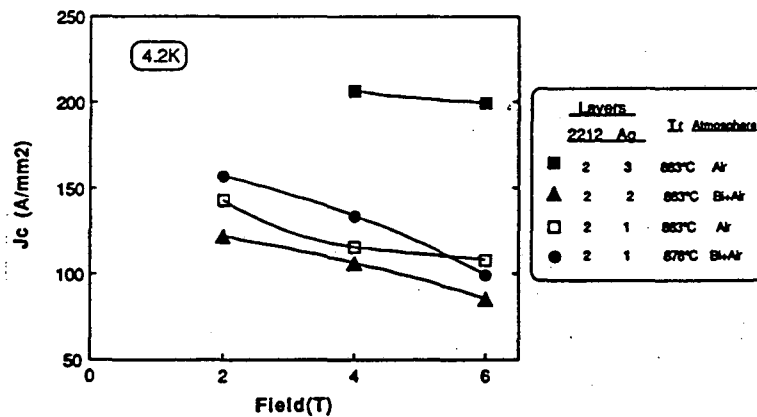

Figure 8 - Transport critical currents in the direction of the long axis of short BSCC-2212 samples of various constructions. Results are for magnetic fields transverse to the long axis and parallel to the flat face of the samples.

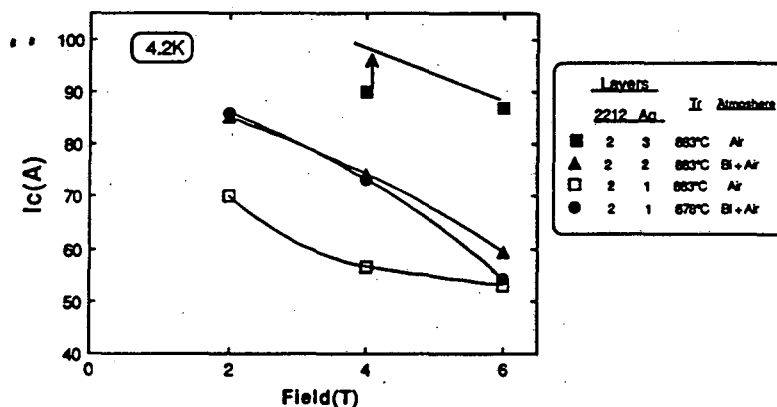

Figure 9 - Transport critical current densities in the direction of the long axis of short BSCC-2212 samples of various constructions. Results are for magnetic fields transverse to the long axis and parallel to the flat face of the samples.

## CONCLUSIONS

Dip coating processes were established for coating meter long strips of silver with BSCCO-2212 powders. First examinations of conductor geometries showed the open faced double sandwiches to yield highest currents and current densities. There are indications that the presence of Bi atmosphere may increase critical current density in the open faced samples, particularly at the higher melt temperatures.

## ACKNOWLEDGEMENTS

The authors would like to thank Dr. Pradeep Haldar and Dr. Leszek Motowidlo for helpful discussions and Dr. Alan Leitzke for assistance with instrumentation and measurements. This work is supported in part by the Director, Office of Energy Research, under the Laboratory Directed Research and Development Program, U.S. Department of Energy under Contract No DE-AC03-76SF00098.

## REFERENCES

1. K. Heine, J. Tenbrink, and M. Thöner: High-field critical current densities in  $\text{Bi}_2\text{Sr}_2\text{Ca}_1\text{Cu}_2\text{O}_{8+x}/\text{Ag}$  wires, *Appl. Phys. Lett.* **55**, 2441 (1989).
2. K. Mimura, N. Enomoto, N. Uno, and M. Nakajima, Proc. ICMC Topical Conf. HTSC Materials Aspects, Garmisch-Partenkirchen, May 9-11, 1990.
3. G.A. Whitlow, J.C. Bowker, W.R. Lovic, F.A. List, D. M. Kroeger, Proc. NYSIS Conf. on Superconductivity and Applications, Buffalo, New York, 1992.
4. J. Kase, T. Morimoto, K. Togano, H. Kumakura, D.R. Dietderich and H. Maeda: Preparation of textured Bi-based oxide tapes by partial melting process, proceedings of Applied Superconductivity Conference, Snowmass CO, September 25-28, 1990, *IEEE Trans. on Magnetics*, (1991).
5. J. Kase, K. Togano, H. Kumakura, D.R. Dietderich, N. Irisawa, T. Morimoto, and H. Maeda: Partial melt growth process of  $\text{Bi}_2\text{Sr}_2\text{Ca}_1\text{Cu}_2\text{O}_x$  textured tapes on silver, *Jpn. J. Appl. Phys.* **29**(7), (1990).

6. D.R. Dietderich, B. Ullmann, H.C. Freyhardt, J. Kase, H. Kumakura, K. Togano, and H Maeda: Textured thick films of  $\text{Bi}_2\text{Sr}_2\text{Ca}_1\text{Cu}_2\text{O}_x$ . Jpn. J. Appl. Phys. **29**(7), (1990).
7. S. Patel et. al., Proc. NYSIS Conf. on Superconductivity and Applications, Buffalo, New York, 1992.
8. K. Togano, H. Kumakura, K. Kadowaki, H. Kitaguchi, H. Maeda, J. Kase, J. Shimoyama and K. Nomura, ICMC'91 Huntsville, Alabama, June 11-14, 1991, Adv. in Cryogenic Eng. Vol. **38**, pg. 1081.
9. J. Shimoyana, N. Tomita, T. Morimoto, H. Kitaguchi, H. Kumakura, K. Togano, H. Maeda, K. Nomura and M. Seido, Jpn. Appl. Phys. Vol. **31** (1992) pp. L1328-L1331.

LAWRENCE BERKELEY LABORATORY  
UNIVERSITY OF CALIFORNIA  
TECHNICAL INFORMATION DEPARTMENT  
BERKELEY, CALIFORNIA 94720

