

# UC Santa Barbara

## UC Santa Barbara Electronic Theses and Dissertations

### Title

Searching for Causality in AdS/CFT

### Permalink

<https://escholarship.org/uc/item/3rq8h57h>

### Author

Kelly, William Ryan

### Publication Date

2015

Peer reviewed|Thesis/dissertation

University of California  
Santa Barbara

# Searching for Causality in AdS/CFT

A dissertation submitted in partial satisfaction  
of the requirements for the degree

Doctor of Philosophy  
in  
Physics

by

William R. Kelly

Committee in charge:

Professor Donald Marolf, Chair  
Professor Gary Horowitz  
Professor Harry Nelson

June 2015

The Dissertation of William R. Kelly is approved.

---

Professor Gary Horowitz

---

Professor Harry Nelson

---

Professor Donald Marolf, Committee Chair

March 2015

Searching for Causality in AdS/CFT

Copyright © 2015

by

William R. Kelly

For Katelynn

## Acknowledgements

There are many people I want to thank but it seems fitting to begin with my advisor, Don Marolf. Don, thank you for showing me what physics looks like when it's done correctly, and for patiently showing me again when I forgot, and then for refreshing my memory just one or two more times after that. I always felt very lucky to have had an advisor who excels both as a scientist and as a teacher. I hope that in my time here I've picked up even a little of your ability to see the forest from the trees.

I owe a similar thank you to Aron Wall. I know that the two years we worked together have, and will continue to have, a lasting impact on me. You taught me countless time to not stop thinking when I sort of understood something, but to keep pushing until every last detail is clear. I'm not sure I ever quite live up to that ideal, but it helps to have a goal.

I'm immensely grateful to all of my collaborators, Don, Tomás, Sebastian, Aron, Jorge, Joan, and Kevin. Doing research has its highs and lows, but you all have made the lows a little less crushing and the highs that much more exhilarating. I hope I've returned the favor. The same goes for a long list of people from whom I've received interesting feedback, discussion, encouragement, and help. In particular I'd like to thank the members of the UCSB high energy journal club, especially (in no particular order) Gavin, Sebastian, Netta, Ben, all three Eric's, Kevin, Alex, Yinbo, Tomás, Benson, Jamie, Ahmed, and Curtis, and my office-mates Curtis, Dan, Kevin, Cathy, Teddy, Alex, and Kelly.

Before any of that work began I had the pleasure of learning from an amazing group of teachers here at UCSB. Thank you especially to Don, Gary, Joe, David,

Steve, Tony, Matthew, Andreas, Chetan, and Cenke for the time and energy you spent teaching me and my classmates. Thank you also, to the many great teachers who taught and encouraged me long before I came to UCSB.

I'm also very grateful for the generous financial support I've received during my time here from the National Science Foundation and the University of California. Thank you Don and Gary, for winning and administering those grants. The freedom to work without distraction, and especially to travel, has made a huge difference in my career thus far.

Thank you also to Don, Gary, and Harry for sitting on my advancement and dissertation committees. Without you I literally could not have made it this far.

Finally, it's nice to have some people to talk to about things other than physics. Thank you to Ben and Alison (and Fiona!), Corrie and Hunter, and Amber and Leon for being such great friends to Katelynn and me. We're going to miss you all a lot. Stay in touch, visit as often as you can, and know that we're thinking of you. The same goes for all of our good friends we don't see nearly often enough.

I'm also grateful to my family for everything they've done for me over the years and for helping make me who I am today. That goes not just for my parents and brother, but also for my extended family, Kwaj family, and my new family of in-laws. You've all provided so much support in so many ways over the years.

Most of all I'm grateful to you, Katelynn, for your love and support through this whole crazy journey. You know me, I'm not one to make a big deal out of stuff, but even I can admit that this is kind of a big year. But what makes it big are not the things that are ending but the things that are beginning. There's not much I know about the future right now except that I'm sticking with you. I love you.

# Curriculum Vitæ

William R. Kelly

## Education

- 2015 Ph.D. in Physics (Expected), University of California, Santa Barbara.
- 2013 M.A. in Physics, University of California, Santa Barbara.
- 2007 B.A. in Liberal Arts, Saint John’s College, Annapolis

## Publications

- (1) J. Camps and W. R. Kelly, “Generalized gravitational entropy without replica symmetry”, *JHEP* **1503** (2015) 061, [arXiv:1412.4093](#).
- (2) W. R. Kelly, “Deriving the First Law of Black Hole Thermodynamics without Entanglement”, *JHEP* **1410** (2014) 192, [arXiv:1408.3705](#).
- (3) W. R. Kelly and A. C. Wall, “A holographic proof of the averaged null energy condition”, *Phys.Rev.* **D90** (2014) 106003, [arXiv:1408.3566](#).
- (4) W. R. Kelly and A. C. Wall, “Coarse-grained entropy and causal holographic information in AdS/CFT”, *JHEP* **1403** (2014) 118, [arXiv:1309.3610](#).
- (5) S. Fischetti, W. Kelly, and D. Marolf, Conserved Charges in Asymptotically (Locally) AdS Spacetimes, [arXiv:1211.6347](#). *Springer Handbook of Spacetime*. edited by: A. Ashtekar and V. Petkov, Springer, (2014)
- (6) W. R. Kelly and D. Marolf, “Phase Spaces for Asymptotically de Sitter Cosmologies”, *Class.Quant.Grav.* **29** (2012) 205013, [arXiv:1202.5347](#).
- (7) W. R. Kelly, Z. Dutton, J. Schlafer, B. Mookerji, T. A. Ohki, J. S. Kline, and D. P. Pappas, “Direct observation of coherent population trapping in a superconducting artificial atom”, *Phys. Rev. Lett.* **104** Apr (2010) 163601.
- (8) W. R. Kelly, E. L. Shirley, A. L. Migdall, S. V. Polyakov, and K. Hendrix, “First- and second-order poisson spots”, *American Journal of Physics* **77** (2009), no. 8, 713–720.



## Abstract

Searching for Causality in AdS/CFT

by

William R. Kelly

String theory with certain asymptotically AdS boundary conditions can be defined non-perturbatively using the AdS/CFT correspondence, which reformulates the theory in terms of a non-gravitational quantum field theory in a lower dimensional spacetime. In this way many of the subtleties of quantizing gravity are circumvented, however, the price of this simplification is that locality is no longer manifest, even in an approximate sense. In this dissertation we study features of asymptotically AdS spacetimes related to causality and search for these properties in the dual CFT description. We begin by reviewing some of the salient features of the correspondence and studying some puzzles related to the Ryu–Takayanagi conjecture. We then show that the notion of boundary causality associated with the Gao–Wald theorem implies that holographic CFT’s on Minkowski space must satisfy the averaged null energy condition (ANEC). The ANEC is a quasilocal energy condition that requires the integrated null energy on a null line to be positive. Any violations of this condition in a holographic theory would result in “causal shortcuts” through the bulk spacetime which would allow propagation outside of the light cone in the CFT. We next study causal wedges associated with subregions of the boundary and argue that these regions of the bulk spacetime are associated with a particular coarse-graining of the CFT reduced density matrix.

In particular, we conjecture that the area of the codimension-two boundary of these wedges is equal to a particular coarse-grained entropy which we name the ‘one-point entropy.’ We present several suggestive examples in which the conjecture holds as well as a proof that it holds to leading order in a class of spacetimes with a bulk first law. In an appendix we explain how the conjecture is equivalent to a statement about the classical Einstein equation which in principle could be rigorously proven or falsified.

# Contents

<b>Curriculum Vitae</b>	<b>vii</b>
<b>Abstract</b>	<b>viii</b>
<b>1 Introduction</b>	<b>1</b>
1.1 Quantizing Gravity with AdS/CFT . . . . .	3
1.2 Entropy, Energy, and Causality . . . . .	8
1.3 Permissions and Attributions . . . . .	10
<b>2 Conserved Charges in Asymptotically (Locally) AdS Spacetimes</b>	<b>12</b>
2.1 Introduction . . . . .	12
2.2 Asymptotically Locally AdS Spacetimes . . . . .	14
2.3 Variational principles and charges . . . . .	35
2.4 Relation to Hamiltonian Charges . . . . .	59
2.5 The algebra of boundary observables and the AdS/CFT correspondence . . . . .	74
<b>3 Generalized gravitational entropy without replica symmetry</b>	<b>80</b>
3.1 Introduction . . . . .	80
3.2 Review of the Lewkowycz–Maldacena derivation . . . . .	85
3.3 Deriving the surface equations of motion without replica symmetry	92
3.4 Generalized entropy for Einstein–Gauss–Bonnet Gravity . . . . .	99
3.5 Discussion . . . . .	107
<b>4 A holographic proof of the averaged null energy condition</b>	<b>110</b>
4.1 Introduction . . . . .	110
4.2 The ANEC in holographic theories . . . . .	113
4.3 Proving the holographic ANEC . . . . .	117
4.4 Discussion . . . . .	123

<b>5</b>	<b>Coarse-grained entropy and causal holographic information</b>	<b>125</b>
5.1	Introduction . . . . .	125
5.2	Causal holographic information: A brief review . . . . .	129
5.3	Coarse-grained entropies . . . . .	132
5.4	The one-point entropy . . . . .	140
5.5	The future one-point entropy . . . . .	161
5.6	Discussion . . . . .	170
<b>6</b>	<b>Deriving the First Law of Black Hole Thermodynamics without Entanglement</b>	<b>173</b>
6.1	Introduction . . . . .	173
6.2	The one point entropy $\mathcal{S}^{(1)}$ . . . . .	177
6.3	A Proof of $\delta S_W = \delta \mathcal{S}^{(1)}$ . . . . .	179
6.4	Discussion . . . . .	188
<b>7</b>	<b>Conclusions</b>	<b>191</b>
<b>A</b>	<b>Coarse-grained entropy details</b>	<b>193</b>
A.1	$\chi$ -preserving coarse grainings . . . . .	193
A.2	Boundary sources . . . . .	194
A.3	Testing $\mathcal{S}^{(1)} = \chi$ . . . . .	196
	<b>Bibliography</b>	<b>198</b>

# Chapter 1

## Introduction

An important observation about the world we live in is that the past seems to influence the future, but not the other way around. In modern physics this observation is closely associated with the theory of relativity because relativistic theories with a well posed initial value formulation have causality properties like those we observe in nature. In particular, the past can only influence the part of spacetime that lies inside its future light cone (see Fig. 1.1).

An early challenge faced by the theory of relativity was to provide a relativistic description of gravity. Gravity provides a unique challenge to the principle of relativity because general arguments suggested (and later experiments confirmed) that the gravitational field deflects light. In order to formulate a relativistic theory of gravity it was ultimately necessary to abandon the concept of a fixed spacetime on which fields propagate and treat spacetime itself as a dynamical object.

Fittingly, it seems that a quantum theory of gravity will require a similarly radical shift in our understanding of spacetime. The uncertainty principle dictates

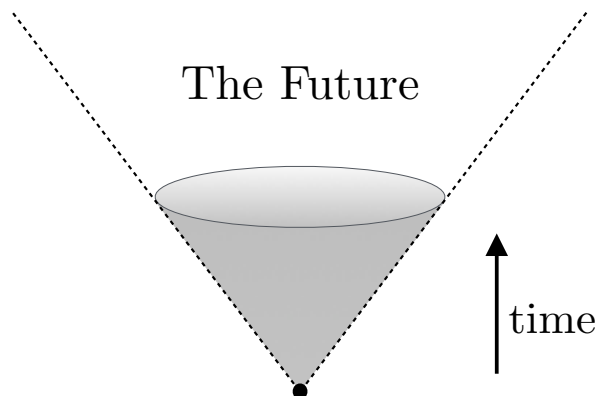

Figure 1.1: The future light cone of a single point in spacetime. The cone and its interior make up the domain of influence of that point.

that quantum fields have significant fluctuations on very small scales. This intuition suggests that the notion of a smooth spacetime will break down at some scale, presumably set by the Planck length  $L_p \sim 10^{-33}$  cm.<sup>1</sup> In this scenario the causal structure of relativity is only meaningful on distance scales much larger than  $L_p$ . Equivalently, we could say that the causal structure of spacetime emerges in the long distance limit of quantum gravity.

In a broad sense this dissertation will focus on the emergence of causality structure in the theory of quantum gravity known as AdS/CFT. More concretely, we study causal properties of asymptotically anti-de Sitter (AdS) spacetimes and interpret them in the language of the dual conformal field theory (CFT). Before stating our main results, we briefly explain how AdS/CFT provides a quantum theory of gravity and motivate the investigations in the following chapters.

---

<sup>1</sup>This intuition is reinforced by the kinematics of the canonical formulation of general relativity. If Poisson brackets are promoted to commutators in the usual way then it follows that “causal structure eigenstates” do not exist.

## 1.1 Quantizing Gravity with AdS/CFT

What does it mean to quantize a physical theory? The answer is best illustrated with a simple example. Consider the classical, one-dimensional simple harmonic oscillator. This system has one degree of freedom  $x(t)$  which satisfies the dynamical equation

$$\ddot{x} = -\omega^2 x, \quad (1.1)$$

where dots denote time derivatives. Say that we observe that (1.1) makes accurate predictions for solutions that satisfy  $\overline{x^2 p^2} \gg \hbar^2$ , where  $p = m\dot{x}$  is the canonical momentum and bars denote time averages. Then we say that this system can be quantized because there exists a Hilbert space  $\mathcal{H}$  equipped with a Hamiltonian  $H$ , a Hermitian operator  $X$ , and a special set of “semi-classical” states  $|x_i\rangle$  such that for each solution  $x_i(t)$  of (1.1) there exists a (highly non-unique) state  $|x_i\rangle$  for which

$$x_i(t) = \langle x_i | e^{iHt/\hbar} X e^{-iHt/\hbar} | x_i \rangle, \quad (1.2)$$

and as we take the amplitude of  $x_i(t)$  to be large (or equivalently  $\hbar \rightarrow 0$ ) quantum fluctuations become negligible. For example, it is typical to take the  $|x_i\rangle$  to be coherent states which have the property

$$\langle x_i | X^2 | x_i \rangle - \langle x_i | X | x_i \rangle^2 \sim \frac{\hbar}{m\omega}, \quad (1.3)$$

independent of the amplitude of  $x_i$ .

In analogy with this simple example, the project of quantizing gravity amounts to finding a Hilbert space, Hamiltonian, physical observables, and semi-classical states which reproduce physically relevant solutions to the Einstein equation

$$G_{\mu\nu}[g_{\mu\nu}] = 8\pi G T_{\mu\nu}. \quad (1.4)$$

Here  $G_{\mu\nu}$  is the Einstein tensor,  $G$  is Newton's constant,  $T_{\mu\nu}$  is the matter stress-energy tensor, and  $g_{\mu\nu}$  is the metric tensor that encodes the geometry of spacetime. The restriction to “physically relevant” solutions excludes considering classical solutions with arbitrarily large curvature or serious pathologies such as closed timelike curves.

A potential solution to this problem is given by AdS/CFT duality [1, 2, 3]. The duality was first worked out in the context of string theory and it is believed that AdS/CFT gives a non-perturbative formulation of string theory. There are many excellent reviews of this subject [4, 5, 6, 7, 8, 9]. We also provide some motivation for the conjecture in section 2.5 below.

The best understood example of the AdS/CFT conjecture states that there is a theory of quantum gravity hidden within the  $\mathcal{N} = 4$  super-Yang–Mills,  $SU(N)$  gauge theory in  $d = 4$  spacetime dimensions. We will not make use of the detailed form of the Lagrangian, however to give a feel for the theory we write it down in a schematic form

$$\mathcal{L}_{SYM} = -\frac{1}{4g^2} \text{Tr} \left[ F^2 + \tilde{\theta} F \wedge F + 2(D_\mu \Phi^I)^2 + \chi \not{D} \chi + \chi [\Phi, \chi] - \sum_{IJ} [\Phi^I, \Phi^J]^2 \right]. \quad (1.5)$$



Here  $F$  is the field strength of a non-abelian gauge field,  $\chi$  is a spinor field, and  $\Phi$  is a scalar. Both  $\chi$  and  $\phi$  are charged under the gauge field and transform in the adjoint representation. The  $\tilde{\theta}$  term integrates to a topological invariant. The presence of this term has implication for properties of the vacuum state, but we will not discuss it any further here.

According to [1] this theory gives a non-perturbative formulation of type IIB string theory on  $\text{AdS}_5 \times S^5$ . The first check of this conjecture is that both theories have the same symmetries. Both theories can be shown to share the same supersymmetries, conformal symmetries, and a discrete  $\text{SL}(2, \mathbb{Z})$  global symmetry at the classical level, and it appears that all of these symmetries are unbroken in the quantum theory. The superconformal symmetries organize operators in the theory into “supermultiplets” that are closed under superconformal transformation. Using this structure it is possible to obtain a complete mapping between the supergravity fields and a supermultiplet generated by single trace, colorless operators (see e.g. [5]).

The next step in formulating the correspondence is matching parameters between the two theories. The gauge theory coupling  $g$  and the rank of the gauge group  $N$  are simply related to the length scale  $L_s$  and closed string coupling  $g_s$  of the string theory. The correspondence is most naturally stated as a relation involving  $N$  and the t’Hooft coupling  $\lambda := g^2 N$  on the field theory side and the string length  $L_s$  and Planck length  $L_p := g_s^{1/4} L_s$  on the string theory side of the duality. In terms of these quantities the map is

$$\left(\frac{L_{\text{AdS}}}{L_s}\right)^4 = 4\pi\lambda, \quad \left(\frac{L_{\text{AdS}}}{L_p}\right)^4 = 4\pi N. \quad (1.6)$$

Here  $L_{\text{AdS}}$  is the length scale of the  $\text{AdS}_5$  (and the radius of the  $S^5$ ) in the string theory vacuum solution. From these relations we see that we expect to recover the Einstein equation (1.4) in the limit  $\lambda \rightarrow \infty, N \rightarrow \infty$ , treating  $\lambda, N$  as independent. Long before [1], t'Hooft showed that in this limit a new perturbative expansion emerges in the field theory with expansion parameter  $1/N$  [10]. Interestingly this perturbative expansion is organized by the Euler number of the associated Feynman diagrams, which was an early hint of a deep connection with string perturbation theory.

Having matched the fields and parameters between the two theories we next consider observables. At this point we must confront the obvious issue that the field theory lives in four spacetime dimensions while the string theory lives in ten. For simplicity we will work only with states that are symmetric in the  $S^5$ . It then only remains to match observables in  $\text{AdS}_5$  with those in the field theory. In this case the map is most natural in Fefferman–Graham gauge (see section 2.2.4 below) in which the  $\text{AdS}_5$  metric takes the form

$$ds^2 = \left( \frac{L_{\text{AdS}}}{z} \right)^2 (dz^2 + g_{\mu\nu}(x, z) dx^\mu dx^\nu) \quad (1.7)$$

subject to the boundary condition that  $g_{\mu\nu}(x, 0)$  is the metric of the field theory spacetime. In these coordinates there is a simple mapping between local, single trace CFT operators and the asymptotic limit of bulk fields that takes the form

$$\mathcal{O}(x) = \lim_{z \rightarrow 0} z^{-\Delta} \phi(x, z), \quad (1.8)$$

where  $\mathcal{O}$  is the CFT operator with conformal dimension  $\Delta$  dual to the bulk field

$\phi$ . Correlation functions between local CFT operators are then computed by taking variational derivatives of the partition function with respect to field theory sources. In the large  $N$  limit this corresponds to computing the variation of the bulk action with respect to the boundary conditions.

The above correspondence provides a simple description of local CFT observables in terms of the bulk spacetime, but it does not manifestly provide a dictionary for operators that are local in the  $\text{AdS}_5$  bulk spacetime. However, local bulk operators can be constructed from non-local CFT operators, often by smearing a local operator over a region of the boundary. The program of constructing these operators and reproducing local bulk physics from the CFT data is known as ‘bulk reconstruction’ and explicit constructions exist, at least perturbatively in a  $1/N$  expansion [11, 12, 13, 14, 15, 16, 17, 18].

A powerful tool for reconstructing the bulk (which we will use extensively below) is the Ryu–Takayanagi conjecture [19, 20]. In words, the Ryu–Takayanagi conjecture states the entanglement entropy of region  $A$  of the CFT is given by the area of a minimal surface in bulk theory, anchored to the boundary of  $A$ . See section 3.1 for a precise statement of the conjecture. Recently, a derivation of the Ryu–Takayanagi conjecture was recently given in [21] and is reviewed in section 3.2 below. This derivation is particularly exciting in light of a series of recent results have suggested that the Ryu–Takayanagi conjecture may be sufficient to derive the bulk equations of motion, at least at the linearized level [22, 23, 24].

## 1.2 Entropy, Energy, and Causality

The focus of the rest of this dissertation will be on using the tools described in the previous section to learn about how bulk causality is encoded in the CFT. We begin in chapter 2 by reviewing the details of the gravitational side of the duality. In particular we present the construction of conserved charges in AdS in a way that demonstrates the sense in which the AdS/CFT dictionary (1.8) is natural.

Because the Ryu–Takayanagi conjecture will play a central role in the later chapters of this dissertation, in chapter 3 we address some puzzles that have arisen when generalizing Ryu–Takayanagi to higher curvature theories of gravity. We explore the space of analytic continuations of the replica manifold that appear in the Lewkowycz–Maldacena derivation of the Ryu–Takayanagi conjecture [21], and show that there exists a suitable analytic continuation for perturbative Gauss–Bonnet gravity. With the appropriate analytic continuation we derive the condition that the entropy is computed by extremizing the Jacobson–Myers entropy of a class of bulk surfaces. We also show that our analytic continuation can be generalized to allow replica breaking saddles without changing our final result. This construction resolves some puzzles about entropy of higher curvature theories that have appeared in the literature, but also raises new questions about the correct procedure for analytically continuing the replica manifolds.

In chapter 4 we show that field theories living on flat space and having a holographic description as an asymptotically AdS spacetime satisfying the Einstein equation must satisfy a positivity condition known as the averaged null energy condition (ANEC). The proof works by showing that if the ANEC were violated in the field theory then signals could propagate outside of the light cone by taking

a shortcut through the bulk spacetime (see Fig. 4.1). This result contributes to an established literature that uses bulk causality to constrain properties of the field theory, which we review in section 4.2. However, whereas most existing results use causality to constrain global properties of the CFT, the ANEC is a quasilocal constraint on the CFT in the sense that it places a constraint on the stress tensor on every null line in Minkowski space.

In chapter 5 we study the causal wedges of [25] defined as the set of all points that lie on causal curves with both endpoints in a boundary domain of dependence (see Fig. 5.1 below). It was proposed in [25] that the causal holographic information  $\chi$ , defined as the area of the codimension-two intersection of the past and future horizons of these wedges, is a measure of information associated with the CFT domain of dependence. We sharpen this intuition by conjecturing that that causal holographic information is equal to a particular coarse grained entropy which we call the ‘one-point entropy’  $\mathcal{S}^{(1)}$ . We present evidence for this proposal and discuss possible generalizations. We expand upon these results in chapter 6 by showing that our conjecture holds to leading order about bulk states that satisfy a first law. This condition includes ball shaped regions of the AdS vacuum state. This fact, together with the reconstruction results of [22, 23], imply that the linearized field equations can be derived from  $\mathcal{S}^{(1)} = \chi$ . Finally, in appendix A we collect some details about  $\mathcal{S}^{(1)}$  and reformulate the conjecture  $\mathcal{S}^{(1)} = \chi$  as a conjecture about the Einstein equations. This reformulation makes the conjecture rigorously testable, though not with existing analytic or numerical methods.

## 1.3 Permissions and Attributions

1. The content of chapter 2 is the result of a collaboration with Sebastian Fischetti and Donald Marolf and has previously appeared as chapter 19 of the Springer Handbook of Spacetime and as a preprint [26]. It is reproduced here with express permission from Springer.
2. The content of chapter 3 is the result of a collaboration with Joan Camps and has previously appeared in the Journal of High Energy Physics (JHEP) [27]. It is reproduced here with the permission of the International School of Advanced Studies (SISSA), Trieste, Italy. [http://jhep.sissa.it/jhep/help/JHEP/CR\\_0A.pdf](http://jhep.sissa.it/jhep/help/JHEP/CR_0A.pdf)
3. The content of chapter 4 is the result of a collaboration with Aron Wall and has previously appeared in Phys. Rev. D [28]. It is reproduced here with permission from the publisher, the American Physical Society: <http://publish.aps.org/copyrightFAQ.html#thesis>. See <http://forms.aps.org/author/copytrnsfr.pdf> for the official copyright transfer agreement.
4. The content of chapter 5 is the result of a collaboration with Aron Wall and has previously appeared in the Journal of High Energy Physics (JHEP) [29]. It is reproduced here with the permission of the International School of Advanced Studies (SISSA), Trieste, Italy. [http://jhep.sissa.it/jhep/help/JHEP/CR\\_0A.pdf](http://jhep.sissa.it/jhep/help/JHEP/CR_0A.pdf)
5. The content of chapter 6 has previously appeared in the Journal of High Energy Physics (JHEP) [30]. It is reproduced here with the permission of

the International School of Advanced Studies (SISSA), Trieste, Italy. [http://jhep.sissa.it/jhep/help/JHEP/CR\\_OA.pdf](http://jhep.sissa.it/jhep/help/JHEP/CR_OA.pdf)

6. Part of the content of appendix A is the result of a collaboration with Aron Wall and all of it has previously appeared in the Journal of High Energy Physics (JHEP) [29, 30]. It is reproduced here with the permission of the International School of Advanced Studies (SISSA), Trieste, Italy. [http://jhep.sissa.it/jhep/help/JHEP/CR\\_OA.pdf](http://jhep.sissa.it/jhep/help/JHEP/CR_OA.pdf)

# Chapter 2

## Conserved Charges in Asymptotically (Locally) AdS Spacetimes

### 2.1 Introduction

When a physical system is complicated and non-linear, global symmetries and the associated conserved quantities provide some of the most powerful analytic tools to understand its behavior. This is as true in theories with a dynamical spacetime metric as for systems defined on a fixed spacetime background.

This chapter will explore the asymptotic symmetries and corresponding conserved charges of asymptotically anti-de Sitter (AdS) spacetimes (and of the more general asymptotically locally AdS spacetimes). There are three excellent reasons for doing so. The first is simply to gain further insight into asymptotic



charges in gravity by investigating a new example. Since empty AdS space is a maximally symmetric solution, asymptotically AdS spacetimes are a natural and simple choice. The second is that the structure one finds in the AdS context is actually much richer than that in asymptotically flat space. At the physical level, this point is deeply connected to the fact (see e.g. [31]) that all multipole moments of a given field in AdS space decay at the same rate at infinity. So while in asymptotically flat space the far field is dominated mostly by monopole terms (with only sub-leading corrections from dipoles and higher multipoles) all terms contribute equally in AdS. It is therefore useful to describe not just global charges (e.g., the total energy) but also the local densities of these charges along the AdS boundary. In fact, it is natural to discuss an entire so-called *boundary stress tensor*  $T_{\text{bdy}}^{ij}$  rather than just the conserved charges it defines.

The third reason to study conserved charges in AdS is their fundamental relation to the anti-de Sitter/Conformal Field Theory (AdS/CFT) correspondence [1, 2, 3], which may well be the most common application of general relativity in 21st century physics. While this is not the place for a detailed treatment of either string theory or AdS/CFT, no Handbook of Spacetime would be complete without presenting at least a brief overview of the correspondence. It turns out that this is easy to do once we have become familiar with  $T_{\text{bdy}}^{ij}$  and its cousins associated with other (non-metric) fields. So at the end of this chapter (section 2.5) we take the opportunity to do so. We will introduce AdS/CFT from the gravity side without using tools from either string theory or conformal field theory.

We will focus on such modern applications below, along with open questions. We make no effort to be either comprehensive or historical. Nevertheless, the

reader should be aware that conserved charges for asymptotically AdS spacetimes were first constructed in [32], where the associated energy was also argued to be positive definite.

The plan for this chapter is as follows. After defining and discussing AdS asymptotics in section 2.2, we construct variational principles for asymptotically AdS spacetimes in section 2.3. This allows us to introduce the boundary stress tensor  $T_{\text{bdy}}^{ij}$  and a similar so-called response function  $\Phi_{\text{bdy}}$  for a bulk scalar field. The conserved charges  $Q[\xi]$  constructed from  $T_{\text{bdy}}^{ij}$  are discussed in section 2.3.4 and we comment briefly on positivity of the energy in section 2.3.5.

Section 2.4 then provides a general proof that the  $Q[\xi]$  do indeed generate canonical transformations corresponding to the desired asymptotic symmetries. As a result, they agree (up to a possible choice of zero-point) with corresponding ADM-like charges  $H[\xi]$  that would be constructed via the AdS-analogues of the standard Hamiltonian techniques. The interested reader can find such a Hamiltonian treatment in [33, 34, 35]. Below, we generally consider AdS gravity coupled to a simple scalar matter field. More complete treatments allowing more general matter fields can be found in e.g. [36, 37, 38]. Section 2.5 then defines the algebra  $\mathcal{A}_{\text{bdy}}$  of boundary observables and provides the above-mentioned brief introduction to AdS/CFT.

## 2.2 Asymptotically Locally AdS Spacetimes

This section discusses the notion of asymptotically locally AdS spacetimes. We begin by introducing empty Anti-de Sitter space itself in section 2.2.1 as a

maximally-symmetric solution to the Einstein equations. We then explore the asymptotic structure of AdS, and in particular its conformal boundary. This structure is used to define the notions of asymptotically AdS (AAdS) and asymptotically locally AdS (AlAdS) spacetimes in section 2.2.3. Section 2.2.4 then discusses the associated Fefferman-Graham expansion which provides an even more detailed description of the asymptotics and which will play a critical role in constructing variational principles, the boundary stress tensor, and so forth in the rest of this chapter. Finally, section 2.2.5 describes how the above structures transform under diffeomorphisms and introduces the notion of an asymptotic Killing vector field.

### 2.2.1 Anti-de Sitter Space

Let us begin with a simple geometric description of  $(d+1)$ -dimensional anti-de Sitter space ( $\text{AdS}_{d+1}$ ) building on the reader's natural intuition for flat geometries. We will, however, need to begin with a flat spacetime  $\mathbb{M}^{2,d}$  of signature  $(2, d)$  having two time-directions and  $d$  spatial directions, so that in natural coordinates  $T^1, T^2, X^1, \dots, X^d$  the line element takes the form

$$ds^2 = -(dT^1)^2 - (dT^2)^2 + (dX^1)^2 + \dots + (dX^d)^2. \quad (2.1)$$

Consider the  $(d+1)$ -dimensional hyperboloid  $\mathcal{H}$  of events in  $\mathbb{M}^{2,d}$  satisfying

$$(T^1)^2 + (T^2)^2 - \sum_{i=1}^d (X^i)^2 = \ell^2, \quad (2.2)$$

and thus which lie at a proper distance  $\ell$  from the origin; see figure 2.1. This

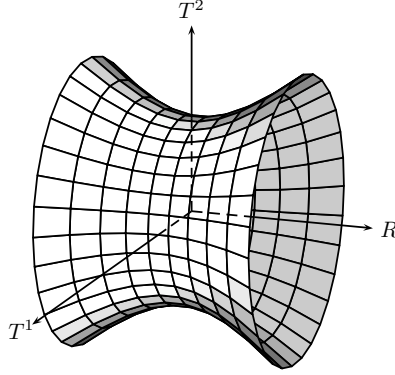

Figure 2.1: The hyperboloid (2.2) embedded in  $\mathbb{M}^{2,d}$ , defining anti-de Sitter space.

hyperboloid is sometimes known as the  $d + 1$  anti-de Sitter space  $\text{AdS}_{d+1}$ , though we will follow a more modern tradition and save this name for a closely related (but much improved!) spacetime that we have yet to introduce.

The isometries of  $\mathcal{H}$  are given by symmetries of  $\mathbb{M}^{2,d}$  preserved by (2.2). Such isometries form the group  $SO(d, 2)$ , generated by the rotation in the  $T^1, T^2$  plane together with two copies of the Lorentz group  $SO(d, 1)$  that act separately on  $T^1, X^1, \dots, X^d$  and  $T^2, X^1, \dots, X^d$ . This gives  $(d + 1)(d + 2)/2$  independent symmetries so that  $\mathcal{H}$  is maximally symmetric.

A simple way to parametrize the hyperboloid is to write  $T^1 = \sqrt{\ell^2 + R^2} \cos(\tau/\ell)$  and  $T^2 = \sqrt{\ell^2 + R^2} \sin(\tau/\ell)$ , with  $R^2 = \sum (X^i)^2$  so that the induced line element on  $\mathcal{H}$  becomes

$$ds_{\text{AdS}_{d+1}}^2 = - (R^2/\ell^2 + 1) d\tau^2 + \frac{dR^2}{R^2/\ell^2 + 1} + R^2 d\Omega_{d-1}^2. \quad (2.3)$$

On  $\mathcal{H}$ , the coordinate  $\tau$  is periodic with period  $2\pi$ . But this makes manifest that  $\mathcal{H}$  contains closed timelike curves such as, for example, the worldline  $R = 0$ . It

is thus useful to unwrap this time direction by passing to the universal covering space of  $\mathcal{H}$  or, more concretely, by removing the periodic identification of  $\tau$  (so that  $\tau$  now lives on  $\mathbb{R}$  instead of  $S^1$ ). We will refer to this covering space as the anti-de Sitter space  $\text{AdS}_{d+1}$  with scale  $\ell$ . Of course, the line element remains that of (2.3). Since any Killing field of  $\mathcal{H}$  lifts readily to the covering space,  $\text{AdS}_{d+1}$  remains maximally symmetric with isometry group given by (a covering group of)  $SO(d, 2)$ .

The coordinates used in (2.3) are called global coordinates anti-de Sitter space, since they cover all of AdS. We can introduce another useful set of coordinates, called Poincaré coordinates, by setting  $z = \ell^2 / (T^1 + X^d)$ ,  $t = \ell T^2 / (T^1 + X^d)$ , and  $x^i = \ell X^i / (T^1 + X^d)$  for  $i = 1, \dots, d - 1$ . The metric then becomes

$$ds_{\text{AdS}_{d+1}}^2 = \frac{\ell^2}{z^2} \left( -dt^2 + \sum_{i=1}^{d-1} (dx^i)^2 + dz^2 \right). \quad (2.4)$$

Poincaré coordinates take their name from the fact that they make manifest a (lower dimensional) Poincaré symmetry associated with the  $d$  coordinates  $t, x^i$ . As is clear from their definitions, these coordinates cover only the region of AdS where  $T^1 + X^d > 0$ . This region is called the the Poincaré patch anti-de Sitter space. While we will not make significant use of (2.4) below, we mention these coordinates here since they arise naturally in many discussions of AdS/CFT which the reader may encounter in the future.

Since AdS is maximally symmetric, its Riemann tensor can be written as an

appropriately symmetrized combination of metric tensors:

$$R_{\mu\nu\sigma\lambda} = \frac{1}{d(d+1)} R (g_{\mu\sigma}g_{\nu\lambda} - g_{\mu\lambda}g_{\nu\sigma}). \quad (2.5)$$

A computation shows that the scalar curvature of AdS is  $R = -d(d+1)/\ell^2$ , and thus that AdS solves the vacuum Einstein field equations with cosmological constant  $\Lambda = -d(d-1)/2\ell^2$ :

$$R_{\mu\nu} - \frac{1}{2} R g_{\mu\nu} + \Lambda g_{\mu\nu} = 0. \quad (2.6)$$

In this sense, AdS is a generalization of flat space to  $\Lambda < 0$ .

## 2.2.2 Conformal Structure and Asymptotic Symmetries of AdS

We now turn to the asymptotic structure of AdS, which will be a crucial ingredient in the construction of conserved charges. It is useful to introduce a new radial coordinate  $r_* = \arctan(R/\ell)$ , so that the line element becomes

$$ds_{\text{AdS}_{d+1}}^2 = \frac{\ell^2}{\cos^2(r_*)} [-d\tau^2/\ell^2 + dr_*^2 + \sin^2(r_*) d\Omega_{d-1}^2]. \quad (2.7)$$

We can immediately identify  $r_* = \pi/2$  as a conformal boundary, leading to the conformal diagrams shown in Figure 2.2.2.

It is evident from the conformal diagram that AdS is not globally hyperbolic. In order to evolve initial data on some spacelike surface  $\Sigma$  arbitrarily far forward (or backward) in time, one needs to supply additional information in the form

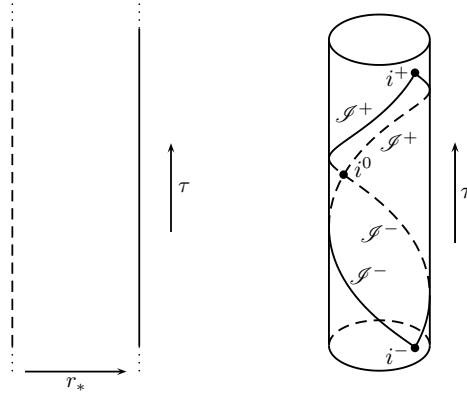

Figure 2.2: Conformal diagrams anti-de Sitter space of  $\text{AdS}_{d+1}$ , showing both the global spacetime and the region covered by the Poincaré patch. In both figures, the  $\tau$  direction extends infinitely to the future and to the past. In (a), a full  $S^{d-1}$  of symmetry has been suppressed, leaving only the  $\tau, r_*$  coordinates of (2.7). The dotted line corresponds to  $r_* = 0$ . In (b), one of the angular directions has been shown explicitly to guide the reader's intuition; the axis of the cylinder corresponds to the dotted line in (a). The Poincaré patch covers a wedge-shaped region of the interior of the cylinder which meets the boundary at the lines marked  $\mathcal{J}^\pm$  and the points marked  $i^\pm, i^0$ . These loci form the null, timelike, and spacelike infinities of the associated region (conformal to Minkowski space) on the AdS boundary.

of boundary conditions at the conformal boundary. Such boundary conditions will be discussed in detail in section 2.3, where they will play critical roles in our discussion of conserved charges.

Although the line element (2.7) diverges at  $r_* = \pi/2$ , the rescaled metric

$$\hat{g} = \frac{\cos^2(r_*)}{\ell^2} g_{\text{AdS}_{d+1}} \quad (2.8)$$

defines a smooth manifold with boundary. In particular, the metric induced by  $\hat{g}$  at  $r_* = \pi/2$  is just that of the flat cylinder  $\mathbb{R} \times S^{d-1}$ , also known as the Einstein static universe (ESU). The manifold with boundary will be called  $M$  and the boundary itself (at  $r_* = \pi/2$ ) will be called  $\partial M$ . Of course, we could equally well have considered the more general rescaled metric

$$\hat{g}' = \frac{\cos^2(r_*)}{\ell^2} e^{2\sigma} g_{\text{AdS}_{d+1}}, \quad (2.9)$$

where  $\sigma$  is an arbitrary smooth function on  $M$ . This metric is also nonsingular at  $r_* = \pi/2$ , but the induced geometry on  $\partial M$  is now only conformal to  $\mathbb{R} \times S^{d-1}$ . The choice of a particular rescaled metric (2.9) (or, equivalently, of a particular rescaling factor  $\frac{\cos^2(r_*)}{\ell^2} e^{2\sigma}$ ) determines a representative of the corresponding conformal class of boundary metrics. This choice (which still allows great freedom to choose  $\sigma$  away from  $\partial M$ ) is known as the choice of conformal frame. We shall often call this representative “the boundary metric,” where it is understood that the above choices must be made for this term to be well-defined.

Although it is not critical for our discussion below, the reader should be aware of the asymptotic structure of the Poincaré patch and how it relates to that of



global AdS as discussed above. From (2.4) we see that the conformal boundary lies at  $z = 0$ . The rescaled metric

$$\hat{g} = \frac{z^2}{\ell^2} g_{\text{AdS}_{d+1}} \quad (2.10)$$

is regular at  $z = 0$ , where the induced metric is just  $d$ -dimensional Minkowski space. Now, it is well known [39] that Minkowski space  $\mathbb{M}^{1,d-1}$  is conformally equivalent to a patch of the Einstein static universe  $\mathbb{R} \times S^{d-1}$ . We conclude that  $z = 0$  of the Poincaré patch is a diamond-shaped piece of  $\partial M$ , as shown at right in Figure 2.2.2.

In the interior of AdS the Poincaré patch covers a wedge-shaped region. This can be thought of as follows: future-directed null geodesics fired from  $i^-$  in Figure 2.2.2 are focused onto  $i^0$ ; these geodesics are generators of a null hypersurface which we shall call the past Poincaré horizon  $\mathcal{H}_{\text{Poincaré}}^-$ . Likewise, future-directed null geodesics fired from  $i^0$  are focused onto  $i^+$ , generating the future Poincaré horizon  $\mathcal{H}_{\text{Poincaré}}^+$ . The Poincaré patch of AdS is the wedge enclosed by these horizons.

### 2.2.3 A definition of Asymptotically Locally AdS Spacetimes

When the spacetime metric is dynamical the choice of boundary conditions plays an especially key role in constructions of conserved charges. In this chapter we consider boundary conditions which force the spacetime to behave asymptotically in a manner at least locally similar to (2.3). It turns out to be useful to

proceed by using the notion of a conformally rescaled metric  $\hat{g}$  which extends sufficiently smoothly to the boundary. After imposing the equations of motion, this  $\hat{g}$  will allow us to very quickly define both asymptotically AdS (AAdS) and asymptotically local AdS spacetimes (AlAdS). Below, we follow [40, 41, 36, 42, 43, 44, 45].

To begin, recall that our discussion of pure AdS above made use of the fact that the unphysical metrics defined in (2.8) and (2.10) could be extended to the conformal boundary  $\partial M$  of AdS. We can generalize this notion by considering any manifold  $M$  (often called ‘the bulk’) with boundary  $\partial M$  and allowing metrics  $g$  which are singular on  $\partial M$  but for which there exists a smooth function  $\Omega$  satisfying  $\Omega|_{\partial M} = 0$ ,  $(d\Omega)|_{\partial M} \neq 0$  (where  $|_{\partial M}$  denotes the pull-back to  $\partial M$ ), and  $\Omega > 0$  on all of  $M$ , such that

$$\hat{g} = \Omega^2 g \tag{2.11}$$

can be extended to all of  $M$  as a sufficiently smooth non-degenerate metric for which the induced metric on  $\partial M$  has Lorentz signature. We will discuss what is meant by sufficiently smooth in more detail in section 2.2.4, but for the purposes of this section one may take  $\hat{g}$  to be  $C^2$  (so that its Riemann tensor is well-defined). Note that  $\hat{g}$  is not unique; given any allowed  $\Omega$  one is always free to choose

$$\Omega' = e^\sigma \Omega, \tag{2.12}$$

for arbitrary smooth  $\sigma$  on  $M$ . Thus, as before, the notion of a particular boundary metric on  $\partial M$  is well-defined only after one has chosen some conformal frame. However, the bulk metric  $g$  does induce a unique conformal structure on  $\partial M$ . The

function  $\Omega$  is termed the defining function conformal frame of the conformal frame. The above structure is essentially that of Penrose's conformal compactifications [46], except that the Lorentz signature of  $\partial M$  forbids  $M$  from being fully compact. In particular, future and past infinity are not part of  $\partial M$ .

In vacuum Einstein-Hilbert gravity with cosmological constant (2.6), we define an asymptotically locally AdS spacetime to be a spacetime  $(g, M)$  as above that solves the Einstein equations (2.6). A key feature of this definition is that it makes no restriction on the conformal structure, or even the topology of the boundary, save that it be compatible with having a Lorentz signature metric. For an asymptotically locally AdS spacetime to be what we will call asymptotically AdS, the induced boundary metric must be conformal to  $\mathbb{R} \times S^{d-1}$ . The reader should be aware that in the literature, the term ‘‘asymptotically AdS’’ (AAdS) is sometimes used synonymously with ‘‘asymptotically locally AdS’’ (AlAdS). Here we emphasize the distinction between the two for pedagogical purposes, as only AAdS spacetimes can truly be said to approach global AdS near  $\partial M$ .

To show that AlAdS spacetimes do in fact approach (2.5) requires the use of the Einstein equations. By writing  $g_{\mu\nu} = \Omega^{-2} \hat{g}_{\mu\nu}$ , a straightforward calculation then shows [44] that near  $\partial M$  we have

$$R_{\mu\nu\sigma\lambda} = -|d\Omega|_{\hat{g}}^2 (g_{\mu\sigma}g_{\nu\lambda} - g_{\nu\sigma}g_{\mu\lambda}) + \mathcal{O}(\Omega^{-3}), \quad (2.13)$$

where

$$|d\Omega|_{\hat{g}}^2 \equiv \hat{g}^{\mu\nu} \partial_\mu \Omega \partial_\nu \Omega \quad (2.14)$$

extends smoothly to  $\partial M$ . Note that since  $g$  has a second-order pole at  $\partial M$ , the

leading-order term in (2.13) is of order  $\Omega^{-4}$ . The Einstein field equations then imply that

$$|d\Omega|_{\hat{g}}^2 = \frac{1}{\ell^2} \quad \text{on } \partial M. \quad (2.15)$$

It follows that Riemann tensor (2.13) of an AlAdS spacetime near  $\partial M$  looks like that of pure AdS (2.5). Further details of the asymptotic structure (and of the approach to (2.3) for the AAdS case) are elucidated by the Fefferman-Graham expansion near  $\partial M$  to which we now turn.

### 2.2.4 The Fefferman-Graham Expansion

The term asymptotically (locally) AdS suggests that the spacetime metric  $g$  should (locally) approach (2.3), at least with a suitable choice of coordinates. This is far from manifest in the definitions above. But it turns out to be a consequence of the Einstein equations. In fact, these equations imply that the asymptotic structure is described by a so-called Fefferman-Graham expansion [47].

The basic idea of this expansion is to first choose a convenient set of coordinates and then to attempt a power-series solution to the Einstein equations. Since the Einstein equations are second order, this leads to a second-order recursion relation for the coefficients of the power series. For, say, simple ordinary differential equations, one would expect the free data in the power series to be parametrized by two of the coefficients. The structure that emerges from the Einstein equations is similar, except for the presence of constraint equations. As we briefly describe below, the constraint equations lead to corresponding constraints on the two otherwise free coefficients. We continue to consider the vacuum case (2.6).

Let us begin by introducing the so-called Fefferman-Graham coordinates on some finite neighborhood  $U$  of  $\partial M$ . To do so, note that since the defining function  $\Omega$  is not unique it is possible to choose a  $\sigma$  in (2.12) such that the modified defining function  $z := \Omega'$  obeys

$$|dz|_{\hat{g}}^2 = \frac{1}{\ell^2} \quad (2.16)$$

on  $U$ , where  $\hat{g} = z^2 g$ . In fact, we can do so with  $\sigma|_{\partial M} = 1$  so that we need not change the conformal frame. We can then take the defining function  $z$  to be a coordinate near the boundary; the notation  $z$  is standard for this so-called ‘‘Fefferman-Graham radial coordinate.’’ We choose the other coordinates  $x^i$  to be orthogonal to  $z$  in  $U$  (according to the metric  $\hat{g}$ ). The metric in these so-called Fefferman-Graham coordinates will then take the form

$$ds^2 = \frac{\ell^2}{z^2} (dz^2 + \gamma_{ij}(x, z) dx^i dx^j), \quad (2.17)$$

where  $i = 0, \dots, d$ . By construction,  $\gamma_{ij}$  can be extended to  $\partial M$ , so it should admit an expansion (at least to some order) in non-negative powers of  $z$ :

$$\gamma_{ij}(x, z) = \gamma_{ij}^{(0)}(x) + z\gamma_{ij}^{(1)}(x) + \dots \quad (2.18)$$

Note that  $\gamma_{ij}^{(0)}$  defines the metric  $\gamma^{(0)}$  on  $\partial M$  in this conformal frame.

Since the Einstein equations are second order partial differential equations, plugging in the ansatz (2.18) leads to a second order recursion relation for the  $\gamma^{(n)}$ . For odd  $d$  this recursion relation admits solutions for all  $\gamma^{(n)}$ . After specifying

$\gamma^{(0)}$ , one finds that all  $\gamma^{(n)}$  with  $n < d$  are uniquely determined (and, in fact  $\gamma^{(n)}$  vanishes for all odd  $n < d$ ). For example, for  $d > 2$  one finds [45]<sup>1</sup>

$$\gamma_{ij}^{(2)} = -\frac{1}{d-2} \left( \mathcal{R}_{ij} - \frac{1}{2(d-1)} \mathcal{R} \gamma_{ij}^{(0)} \right), \quad (2.19)$$

where  $\mathcal{R}, \mathcal{R}_{ij}$  are respectively the Ricci tensor and Ricci scalar of  $\gamma^{(0)}$ .

However, new data enters in  $\gamma^{(d)}$ . This new data is subject to constraints analogous to those that arise in the Hamiltonian formalism. Indeed, these constraints may be derived by considering the analogues of the Hamiltonian and momentum constraints on surfaces with  $z = \text{constant}$ . They determine the trace and divergence of  $\gamma^{(d)}$  (again for  $d$  odd) through

$$(\gamma^{(0)})^{ij} \gamma_{ij}^{(d)} = 0, \quad (\gamma^{(0)})^{ki} D_k \gamma_{ij}^{(d)} = 0, \quad (2.20)$$

where  $D_k$  is the  $\gamma^{(0)}$ -compatible derivative operator on  $\partial M$  (where we think of all  $\gamma^{(n)}$  as being defined). We will give a short argument for (2.20) in section 2.3.4. Once we have chosen any  $\gamma^{(d)}$  satisfying (2.20), the recursion relation can then be solved order-by-order to express all higher  $\gamma^{(n)}$  in terms of  $\gamma^{(0)}$  and  $\gamma^{(d)}$ . Of course, the series (2.17) describes only the asymptotic form of the metric. There is no guarantee that there is in fact a smooth solution in the interior matching this asymptotic data, or that such a smooth interior solution is unique when it exists.

The situation is slightly more complicated for even  $d$ , where the recursion

---

<sup>1</sup>We caution the reader to be wary of the differing sign conventions in the literature. For example, the sign conventions for Riemann and extrinsic curvatures used in [45] are opposite from the ones used here.

relations for the ansatz (2.18) break down at the order at which  $\gamma^{(d)}$  would appear. To proceed, one must allow logarithmic terms to arise at this order and use the more general ansatz

$$\gamma_{ij}(x, z) = \gamma_{ij}^{(0)} + z^2 \gamma_{ij}^{(2)} + \cdots + z^d \gamma_{ij}^{(d)} + z^d \bar{\gamma}_{ij}^{(d)} \log z^2 + \cdots, \quad (2.21)$$

where, since the structure is identical for all  $d$  up to order  $n = d$ , we have made manifest that  $\gamma^{(n)} = 0$  for all odd  $n < d$ . The higher order terms represented by  $\cdots$  include both higher even powers of  $z$  and such terms multiplied by  $\log z$ . One finds that  $\bar{\gamma}^{(d)}$  is fully determined by  $\gamma^{(0)}$  and satisfies

$$(\gamma^{(0)})^{ij} \bar{\gamma}_{ij}^{(d)} = 0, \quad (\gamma^{(0)})^{ki} D_k \bar{\gamma}_{ij}^{(d)} = 0. \quad (2.22)$$

For example, for  $d = 2, 4$ , one obtains [45]

$$\bar{\gamma}_{ij}^{(2)} = 0, \quad (2.23)$$

$$\begin{aligned} \bar{\gamma}_{ij}^{(4)} = & \frac{1}{8} \mathcal{R}_{ikjl} \mathcal{R}^{kl} - \frac{1}{48} D_i D_j \mathcal{R} + \frac{1}{16} D^2 \mathcal{R}_{ij} - \frac{1}{24} \mathcal{R} \mathcal{R}_{ij} \\ & + \left( -\frac{1}{96} D^2 \mathcal{R} + \frac{1}{96} \mathcal{R}^2 - \frac{1}{32} \mathcal{R}_{kl} \mathcal{R}^{kl} \right) \gamma_{ij}^{(0)}, \end{aligned} \quad (2.24)$$

where  $\mathcal{R}_{ijkl}$  is the Riemann tensor of  $\gamma^{(0)}$ , and indices are raised and lowered with  $\gamma^{(0)}$ . But  $\gamma^{(d)}$  may again be chosen freely subject to dimension-dependent

conditions that fix its divergence and trace. As examples, one finds [45]

$$d = 2 : (\gamma^{(0)})^{ij} \gamma_{ij}^{(d)} = -\frac{1}{2} \mathcal{R}, \quad D^i \gamma_{ij}^{(d)} = -\frac{1}{2} D_j \mathcal{R}, \quad (2.25)$$

$$d = 4 : (\gamma^{(0)})^{ij} \gamma_{ij}^{(d)} = \frac{1}{16} \left( \mathcal{R}_{ij} \mathcal{R}^{ij} - \frac{2}{9} \mathcal{R}^2 \right), \quad (2.26)$$

$$D^i \gamma_{ij}^{(d)} = \frac{1}{8} \mathcal{R}_i{}^k D^i \mathcal{R}_{kj} - \frac{1}{32} D_j (\mathcal{R}^{ik} \mathcal{R}_{ik}) + \frac{1}{288} \mathcal{R} D_j \mathcal{R}. \quad (2.27)$$

The higher terms in the series are again uniquely determined by  $\gamma^{(0)}$ ,  $\gamma^{(d)}$ .

In general, the terms  $\gamma^{(n)}$  become more and more complicated at each order. But the expansion simplifies when  $\gamma_{ij}^{(0)}$  is conformally flat and  $\gamma_{ij}^{(d)} = 0$ . In this case one finds [48] that the recursion relation can be solved exactly and terminates at order  $z^4$ . In particular, the bulk metric so obtained is also conformally flat, and is thus locally  $\text{AdS}_{d+1}$ . For  $d = 2$ , the Fefferman-Graham expansion can be integrated exactly for any  $\gamma^{(0)}$ ,  $\gamma^{(d)}$ , and always terminates at order  $z^4$  to define a metric that is locally  $\text{AdS}_3$ .

### 2.2.5 Diffeomorphisms and symmetries in AlAdS

The reader of this Handbook is by now well aware of the important roles played by diffeomorphisms in understanding gravitational physics. Let us therefore pause briefly to understand how such transformations affect the structures defined thus far. We are interested in diffeomorphisms of our manifold  $M$  with boundary  $\partial M$ . By definition, any such diffeomorphism must map  $\partial M$  to itself; i.e., it also induces a diffeomorphism of  $\partial M$ . As usual in physics, we consider diffeomorphisms (of  $M$ ) generated by vector fields  $\xi$ ; the corresponding diffeomorphism of  $\partial M$  is generated by some  $\hat{\xi}$ , which is just the restriction of  $\xi$  to  $\partial M$  (where by the above it must



be tangent to  $\partial M$ ).

Of course, the metric  $g$  transforms as a tensor under this diffeomorphism. But if we think of the diffeomorphism as acting only on dynamical variables of the theory then the defining function  $z = \Omega$  does not transform at all, and in particular does not transform like a scalar field. This means that the rescaled metric  $\hat{g} = z^2 g$  does *not* transform like a tensor, and neither does the boundary metric  $\gamma^{(0)}$ . Instead, the diffeomorphism induces an additional conformal transformation on  $\partial M$ ; i.e., a change of conformal frame.

We can make this explicit by considering diffeomorphisms asymptotically locally AdS that preserve the Fefferman-Graham gauge conditions; i.e., which satisfy

$$\delta g_{zz} = 0 = \delta g_{iz} \quad (2.28)$$

for

$$\delta g_{\mu\nu} = \mathcal{L}_\xi g_{\mu\nu} = \nabla_\mu \xi_\nu + \nabla_\nu \xi_\mu, \quad (2.29)$$

where we use  $\mathcal{L}_\xi$  to denote Lie derivatives along  $\xi$  and  $\nabla_\mu$  is the covariant derivative compatible with the metric  $g$  on  $M$ . Let us decompose the components  $\delta g_{\mu\nu}$  into

$$\mathcal{L}_\xi g_{zz} = \frac{2\ell}{z} \partial_z \left( \frac{\ell}{z} \xi^z \right), \quad (2.30)$$

$$\mathcal{L}_\xi g_{iz} = \frac{\ell^2}{z^2} (\partial_i \xi^z + \gamma_{ij} \partial_z \xi^j), \quad (2.31)$$

$$\mathcal{L}_\xi g_{ij} = \frac{\ell^2}{z^2} \left( \mathcal{L}_\xi \gamma_{ij} + z^2 \partial_z (z^{-2} \gamma_{ij}) \xi^z \right), \quad (2.32)$$

where  $\mathcal{L}_\xi$  is the Lie derivative with respect to  $\hat{\xi}$  on  $\partial M$ . These conditions can be

integrated using (2.28) to obtain

$$\xi^z = z\hat{\xi}^z(x), \quad (2.33)$$

$$\xi^i = \hat{\xi}^i(x) - \partial_j \hat{\xi}^z \int_0^z z' \gamma^{ji}(z') dz', \quad (2.34)$$

where  $\hat{\xi}^z$  and  $\hat{\xi}^i$  are an arbitrary function and vector field on  $\partial M$  (which we may transport to any  $z = \text{constant}$  surface by using the given coordinates to temporarily identify that surface with  $\partial M$ ). In particular, for  $\hat{\xi}^i = 0$  we find

$$g_{ij} + \delta g_{ij} = \frac{\ell^2}{z^2} \left(1 - 2\hat{\xi}^z\right) \gamma_{ij}^{(0)} + \mathcal{O}(z^0). \quad (2.35)$$

Thus the boundary metric transforms as  $\gamma^{(0)} \rightarrow e^{-2\hat{\xi}^z} \gamma_{ij}^{(0)}$ . Such transformations are called conformal transformations by relativists and Weyl transformations by particle physicists; we will use the former, but the reader will find both terms in various treatments of AlAdS spacetimes. This is precisely the change of conformal frame mentioned above.

Let us now turn to the notion of symmetry. We might be interested either in an exact symmetry of some metric  $g$ , generated by a Killing vector field (KVF) satisfying  $\nabla_{(\nu} \xi_{\mu)} = 0$ , or in some notion of asymptotic symmetry. We will save the precise definition of an asymptotic symmetry for section 2.3.3 as, strictly speaking, this first requires the construction an appropriate variational principle and a corresponding choice of boundary conditions. However, we will discuss the closely related (but entirely geometric) notion of an asymptotic Killing field below.

Suppose first that  $\xi$  is indeed a KVF of  $g$  so that  $\mathcal{L}_\xi g = 0$ . It is clear that there are two cases to consider. Either  $\mathcal{L}_\xi \Omega = 0$  (in which case we say that  $\xi$  is

compatible with  $\Omega$ ) or  $\mathcal{L}_\xi \Omega \neq 0$  (in which case we say that  $\xi$  is not compatible with  $\Omega$ ). In the former case we clearly have  $\mathcal{L}_\xi \hat{g} = \mathcal{L}_\xi(\Omega^2 g) = 0$  so that  $\xi$  is also a Killing field of  $\hat{g}$ . But more generally we have seen that the corresponding diffeomorphism changes  $\hat{g}$  by a conformal factor. The generators of such diffeomorphisms are called conformal Killing fields of  $\hat{g}$  (see e.g. Appendix C.3 of [39]) and satisfy

$$\mathcal{L}_\xi \hat{g}_{\mu\nu} = (\mathcal{L}_\xi \ln \Omega^2) \hat{g}_{\mu\nu} + 2 \widehat{\nabla}_{(\mu} \xi_{\nu)} = \frac{2}{d+1} \left( \widehat{\nabla}_\sigma \xi^\sigma \right) \hat{g}_{\mu\nu}, \quad (2.36)$$

where  $\widehat{\nabla}$  is the covariant derivative compatible with  $\hat{g}$ , and indices on  $\xi^\mu$  are lowered with  $\hat{g}_{\mu\nu}$ . Note that the induced vector field  $\hat{\xi}$  on  $\partial M$  is again a conformal Killing field of  $\gamma^{(0)}$ .

This suggests that we define an asymptotic Killing field to be any vector field  $\xi$  that satisfies (2.36) to leading order in  $\Omega$  at  $\partial M$ . If we ask that  $\xi$  also preserve Fefferman-Graham gauge we may then expand (2.33) and (2.34) and insert into (2.36) to obtain

$$\xi^z = z \hat{\xi}^z(x), \quad (2.37)$$

$$\xi^i = \hat{\xi}^i(x) - \frac{1}{2} z^2 (\gamma^{(0)})^{ij} \partial_j \hat{\xi}^z + \mathcal{O}(z^4), \quad (2.38)$$

$$\mathcal{L}_{\hat{\xi}} \gamma_{ij}^{(0)} - \frac{2}{d+1} \left( D_k \hat{\xi}^k + \hat{\xi}^z \right) \gamma_{ij}^{(0)} = 0. \quad (2.39)$$

Taking the trace of the condition (2.39) shows that  $\hat{\xi}^z = \frac{1}{d} D_i \hat{\xi}^i$ , so (2.39) is the conformal Killing equation for  $\hat{\xi}$  with respect to  $\gamma^{(0)}$ . In other words, conformal Killing fields  $\hat{\xi}$  of  $\gamma^{(0)}$  are in one-to-one correspondence with asymptotic Killing fields of  $g$  which preserve Fefferman-Graham gauge, where the equivalence relation

is given by agreement to the order shown in (2.38).

## 2.2.6 Gravity with Matter

Our treatment above has focused on vacuum gravity. It is useful to generalize the discussion to include matter fields, both to see how this influences the above result and also to better elucidate the general structure of asymptotically AdS field theory. Indeed, readers new to dynamics in AdS space will gain further insight from section 2.2.4 if they re-read it after studying the treatment of the free scalar field below. We use a single scalar as an illustrative example of matter fields; see [36, 37] for more general discussions.

For simplicity, we first consider a massive scalar field in a fixed AlAdS<sub>d+1</sub> gravitational background, which we take to be in Fefferman-Graham form (2.17). This set-up is often called the probe approximation as it neglects the back-reaction of the matter on the spacetime. The action is as usual

$$S_\phi^{Bulk} = -\frac{1}{2} \int d^{d+1}x \sqrt{|g|} (g^{\mu\nu} \partial_\mu \phi \partial_\nu \phi + m^2 \phi^2). \quad (2.40)$$

We study the behavior of solutions near the boundary  $z = 0$  by seeking solutions which behave at leading order like  $z^\Delta$  for some power  $\Delta$ . The equation of motion

$$(-\square + m^2) \phi = 0 \quad (2.41)$$

then requires  $(m\ell)^2 = \Delta(\Delta - d)$ , yielding two independent small- $z$  behaviors  $z^{\Delta_\pm}$ . Here we have defined  $\Delta_\pm = d/2 \pm \nu$ , with  $\nu \equiv \sqrt{(d/2)^2 + (m\ell)^2}$ . A priori, it seems that we should consider only  $\nu \geq \nu_{\min}$  for some  $\nu_{\min} > 0$ , since one

might expect  $(m\ell)^2 \geq 0$ . However, it can be shown [49] that scalar fields with small tachyonic masses in  $\text{AdS}_{d+1}$  are stable as long as the mass satisfies the so-called Breitenlohner-Freedman (BF) bound  $(m\ell)^2 \geq -d^2/4 =: m_{BF}^2$ ; we therefore consider  $\nu \geq 0$ . The essential points here are: i) It is only for  $|(m\ell)^2| \gg 1$  that the flat-space approximation must hold, so for small  $|(m\ell)^2|$  the behavior can differ significantly from that of flat space; ii) as noted above, the fact that AdS is not globally hyperbolic means that we must impose boundary conditions at  $\partial M$ . These boundary conditions generally require  $\phi$  to vanish on  $\partial M$ . So even for  $m^2 = 0$  we would exclude the ‘zero mode’  $\phi = \text{constant}$ . For a given boundary condition, the spectrum of modes turns out to be discrete. As a result, we may lower  $m^2$  a finite amount below zero before a true instability develops.

The asymptotic analysis above suggests that we seek a solution of the form

$$\phi(x, z) = z^{\Delta_-} (\phi^{(0)} + z^2 \phi^{(2)} + \dots) + z^{\Delta_+} (\phi^{(2\nu)} + z^2 \phi^{(2\nu+2)} + \dots). \quad (2.42)$$

For non-integer  $\nu$  the equation of motion can be solved order-by-order in  $z$  to uniquely express all coefficients in terms of  $\phi^{(0)}$  and  $\phi^{(2\nu)}$ . But for integer  $\nu$  the difference  $\Delta_+ - \Delta_-$  is an even integer and the two sets of terms in (2.42) overlap. This notational issue is connected to a physical one: keeping only even-integer powers of  $z$  (times  $z^{\Delta_-}$ ) does not allow enough freedom to solve the resulting recursion relation; there is no solution at order  $d - 2\Delta_-$ . To continue further we must introduce a logarithmic term and write:

$$\phi(x, z) = z^{\Delta_-} (\phi^{(0)} + z^2 \phi^{(2)} + \dots) + z^{\Delta_+} \log z^2 (\psi^{(2\nu)} + z^2 \psi^{(2\nu+2)} + \dots). \quad (2.43)$$

The recursion relations then uniquely express all coefficients in terms of the free coefficients  $\phi^{(0)}$  and  $\phi^{(2\nu)}$ . As an example, we note for later purposes that (for any value of  $\nu$ )

$$\phi^{(2)} = \frac{1}{4(\nu-1)} \square^{(0)} \phi^{(0)}, \quad (2.44)$$

where  $\square^{(0)}$  is the scalar wave operator defined by  $\gamma^{(0)}$  on  $\partial M$ . Dimensional analysis shows that the higher coefficients  $\phi^{(n)}$  for integer  $n < 2\Delta_+ - d$  involve  $n$  derivatives of  $\phi^{(0)}$ .

We now couple our scalar to dynamical gravity using

$$S = S_{\text{grav}} + S_{\phi}^{\text{Bulk}}, \quad (2.45)$$

where  $S_{\text{grav}}$  is the action for gravity. We will postpone a discussion of boundary terms to section 2.3; for now, we simply focus on solving the resulting equations of motion

$$R_{\mu\nu} - \frac{1}{2} R g_{\mu\nu} + \Lambda g_{\mu\nu} = 8\pi G T_{\mu\nu}^{(\text{matter})}. \quad (2.46)$$

As in the vacuum case we write the metric in the form (2.17), and as in the solution for nondynamical gravity we write the scalar field as in (2.43). Note that we keep the logarithmic term in (2.21) for all  $d$  as, depending on the matter content, it may be necessary even for odd  $d$ . (When it is not needed, the equations of motion force its coefficient  $\bar{\gamma}_d$  to vanish.) The stress tensor of the scalar field then behaves like

$$T_{\mu\nu}^{(\text{matter})} dx^\mu dx^\nu = \Delta_- z^{2(\Delta_- - 1)} \left[ \frac{d}{2} (\phi^{(0)})^2 dz^2 + z \phi^{(0)} \partial_i \phi^{(0)} dz dx^i + \nu (\phi^{(0)})^2 \gamma_{ij}^{(0)} dx^i dx^j + \dots \right]. \quad (2.47)$$

For  $\Delta_- < 0$  and  $\phi^{(0)} \neq 0$ , the matter stress tensor turns out to diverge too rapidly at  $z = 0$  for the equations of motion to admit an AlAdS solution. So for  $\Delta_- < 0$  the only scalar field boundary condition consistent with the desired physics is  $\phi^{(0)} = 0$ . But for  $\Delta_- \geq 0$  the equations of motion *do* admit AlAdS solutions with  $\phi^{(0)} \neq 0$  and further input is required to determine the boundary conditions. We will return to this issue in section 2.3.2.

Evidently, the equations of motion admit solutions of the forms (2.17) and (2.43) only if the components of the matter stress tensor in Fefferman-Graham coordinates diverge as  $1/z^2$  or slower. This result allows us to generalize our definition of asymptotically locally AdS spacetimes to include matter: an AlAdS spacetime with matter asymptotically locally AdS is a manifold  $M$  as above with fields satisfying the equations of motion and the requirement that  $\Omega^2 T_{\mu\nu}$  admits a continuous limit to  $\partial M$ .

## 2.3 Variational principles and charges

Noether's theorem teaches us that variational principles provide a powerful link between symmetries and conservation laws, allowing the latter to be derived without detailed knowledge of the equations of motion. This procedure works as well for gravitational theories as for systems defined on a fixed spacetime background, though there is one additional subtlety. In more familiar theories, it is often sufficient to consider only variations of compact support so that all boundary terms arising from variations of an action can be discarded. In the asymptotically flat context, when the gravitational constraints (which are just certain equations

of motion!) are satisfied the gravitational charges become pure boundary terms with no contributions from the bulk. Discarding all boundary terms in Noether's theorem would thus lead to trivial charges and we will instead need to treat boundary terms with care. It is in part for this reason that we refer to *variational principles* as opposed to mere actions, the distinction being that all variations of the former vanish when the equations of motion and boundary conditions hold, even including any boundary terms that may arise in computing the variations. Constructing a good variational principle generally requires that we add boundary terms to the familiar bulk action, and that we tailor the choice of such boundary terms to the boundary conditions we wish to impose on  $\partial M$ .

### 2.3.1 A toy model of AdS: Gravity in a box

We have seen that AlAdS spacetimes are conformally equivalent to manifolds with timelike boundaries. This means that (with appropriate boundary conditions) light signals can bounce off of  $\partial M$  and return to the interior in finite time, boundary conditions are needed for time evolution, and indeed much of physics in AlAdS spacetimes is indeed like field theory in a finite-sized box. This analogy also turns out to hold for the study of conservation laws in theories with dynamical gravity. It will therefore prove useful to first study conservation laws for gravity on a manifold  $M$  with a finite-distance timelike boundary  $\partial M$ , which will serve as a toy model for AlAdS gravitational dynamics. This subject, which we call “gravity in a box”, Variational Principle was historically studied for its own sake by Brown and York [50]. We largely follow their approach below. For simplicity we will assume that  $\partial M$  is globally hyperbolic with compact Cauchy surfaces as



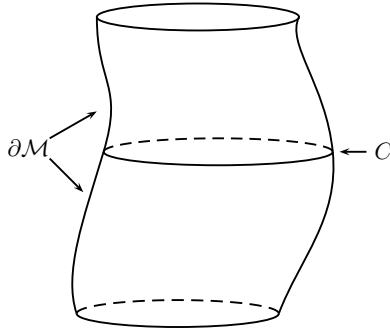

Figure 2.3: A sketch of the spacetime  $\mathcal{M}$ . The codimension two surface  $C$  is a Cauchy surface of the boundary  $\partial\mathcal{M}$ .

shown in figure 2.3, though the more general case can typically be treated by imposing appropriate boundary conditions in the asymptotic regions of  $\partial\mathcal{M}$ .

Our first task is to construct a good variational principle. But as noted above this will generally require us to add boundary-condition-dependent boundary terms to the bulk action. It is thus useful to have some particular boundary condition (or, at least, a class of such conditions) in mind before we begin. In scalar field theory, familiar classes of boundary conditions include the Dirichlet condition ( $\phi|_{\partial\mathcal{M}}$  fixed, so  $\delta\phi|_{\partial\mathcal{M}} = 0$ ), the Neumann condition (which fixes the normal derivative), or the more general class of Robin conditions (which fix a linear combination of the two). All of these have analogues for our gravity in a box system, but for simplicity we will begin with a Dirichlet-type condition. When discussing the initial value problem, the natural initial data on a Cauchy surface consists of the induced metric and the extrinsic curvature (or, equivalently, the conjugate momentum). Since the equations of motion are covariant, the analysis of possible boundary conditions on timelike boundaries turns out to be very similar so that the natural Dirichlet-type condition is to fix the induced metric  $h_{ij}$  on

$\partial M$ .

An important piece of our variational principle will of course be the Einstein-Hilbert action  $S_{EH} = \frac{1}{2\kappa} \int \sqrt{-g} R$  (with  $\kappa = 8\pi G$ ). But  $S_{EH}$  is not sufficient by itself as a standard calculation gives

$$\begin{aligned} \delta S_{EH} &= \delta \left( \frac{1}{2\kappa} \int_M \sqrt{-g} R \right) \\ &= \frac{1}{2\kappa} \int_M \sqrt{-g} \left( R_{\mu\nu} - \frac{1}{2} R g_{\mu\nu} \right) \delta g^{\mu\nu} + \frac{1}{2\kappa} \int_{\partial M} \sqrt{|h|} \hat{r}_\lambda G^{\mu\nu\rho\lambda} \nabla_\rho \delta g_{\mu\nu} \end{aligned} \quad (2.48)$$

where  $\hat{r}^\lambda$  is the outward pointing unit normal to  $\partial M$  and

$$G^{\mu\nu\rho\lambda} = g^{\mu(\rho} g^{\lambda)\nu} - g^{\mu\nu} g^{\rho\lambda}. \quad (2.49)$$

In (2.48) we have discarded boundary terms not associated with  $\partial M$  (i.e., boundary terms in any asymptotic regions of  $M$ ) as they will play no role in our analysis. Nevertheless, the second term in (2.48) (the boundary term) generally fails to vanish for useful boundary conditions, so that  $S_{EH}$  is not fully stationary on solutions.

However, when  $\delta h_{ij} = 0$  this problem term turns out to be an exact variation of another boundary term, known as the Gibbons-Hawking term, given by the integral of the trace of the extrinsic curvature of  $\partial M$ . (For related reasons the addition of this term is necessary when constructing a gravitational path integral, see [51]). As a result, enforcing the boundary condition  $\delta h_{ij} = 0$  guarantees that

all variations of the action

$$S_{\text{Dirichlet in a box}} = S_{EH} + S_{GH} = \frac{1}{2\kappa} \int_{\mathcal{M}} \sqrt{-g} R - \frac{1}{\kappa} \int_{\partial M} \sqrt{|h|} K \quad (2.50)$$

vanish precisely when the bulk equations of motion hold. Here,  $K = h_{ij} K^{ij}$  is the trace of the extrinsic curvature on  $\partial M$ , with  $K_{ij} = -(\mathcal{L}_n h_{ij})/2$ , where  $n$  is the outward-pointing unit normal to  $\partial M$ . Thus (2.50) gives a good variational principle for our Dirichlet problem.

Now, Noether's theorem teaches us that every continuous symmetry of our system should lead to a conservation law (though the conservation laws associated with pure gauge transformations are trivial). Gravity in a box is defined by the action (2.50) and by the choice of some Lorentz-signature metric  $h_{ij}$  on  $\partial M$ . The first ingredient, the action (2.50), is manifestly invariant under any diffeomorphisms of  $M$ . Such diffeomorphisms are generated by vector fields  $\xi$  on  $M$  that are tangent to  $\partial M$  at the boundary (so that the diffeomorphism maps  $\partial M$  to itself). As before, we use  $\hat{\xi}$  to denote the induced vector field on  $\partial M$ . The associated diffeomorphism of  $M$  will preserve  $h_{ij}$  if  $\hat{\xi}$  is a Killing field on the boundary. A diffeomorphism supported away from the boundary should be pure gauge. So it is natural to expect that the asymptotic symmetries of our system are classified by the choice of boundary Killing field  $\hat{\xi}$ , with the particular choice of a bulk extension  $\xi$  being pure gauge.

This set up should remind the reader of (non-gravitational) field theories on fixed spacetime backgrounds. There one finds conservation laws associated with each Killing field of the background metric. Here again the conservation laws are

associated with Killing fields of the background structure, though now the only such structure is the boundary metric  $h_{ij}$ .

Pursuing this analogy, let us recall the situation for field theory on a fixed (non-dynamical) spacetime background. There, Noether's theorem for global symmetries (e.g., translations along some Killing field  $\xi_{KVF}$ ) would instruct us to vary the action under a space-time generalization of the symmetry (e.g., diffeomorphism along  $f(x)\xi_{KVF}$  for general smooth functions  $f(x)$ , or more generally under arbitrary diffeomorphisms). It is clear that the analogue for gravity in a box is just to vary (2.50) under a general diffeomorphism of  $M$ .

It turns out to be useful to do so in two steps. Let us first compute an arbitrary variation of (2.50). By construction, it must reduce to a boundary term when the equations of motion hold, and it must vanish when  $\delta h_{ij} = 0$ . Thus it must be linear in  $\delta h_{ij}$ . A direct calculation (see appendix E of [39]) gives

$$\delta S_{\text{Dirichlet in a box}} = \frac{1}{2} \int_{\partial M} \sqrt{|h|} \tau^{ij} \delta h_{ij}, \quad (2.51)$$

where  $\tau^{ij} = \kappa^{-1}(K^{ij} - Kh^{ij})$ . This  $\tau^{ij}$  is sometimes referred to as the radial conjugate momentum since it has the same form as the (undensitized) conjugate momentum introduced on spacelike surfaces in the Hamiltonian formalism. This agreement of course follows from general principles of Hamilton-Jacobi theory. The reader should recall that for field theory in a fixed spacetime background the functional derivative of the action with respect to the metric defines the field theory stress tensor. By analogy, the object  $\tau^{ij}$  defined above is often called the boundary stress tensorstress tensor (or the Brown-York stress tensorstress tensor)

of the gravitational theory.

Let us now specialize to the case where our variation is a diffeomorphism of  $M$ . As we have seen,  $\xi$  also induces a diffeomorphism of the boundary  $\partial M$  generated by some  $\hat{\xi}$ . Then  $\delta h_{ij} = D_i \hat{\xi}_j + D_j \hat{\xi}_i$ , where  $D_i$  is the covariant derivative compatible with  $h_{ij}$ . Using the symmetry of  $\tau^{ij} = \tau^{ji}$  we find

$$\delta S_{\text{Dirichlet in a box}} = \int_{\partial M} \sqrt{|h|} \tau^{ij} D_i \hat{\xi}_j = - \int_{\partial M} \sqrt{|h|} \hat{\xi}_j D_i \tau^{ij}, \quad (2.52)$$

where in the last step we integrate by parts and take  $\hat{\xi}$  to have compact support on  $\partial M$  so that we may discard any boundary terms. Since  $\hat{\xi}$  is otherwise arbitrary, we conclude that

$$D_i \tau^{ij} = 0; \quad (2.53)$$

i.e.,  $\tau^{ij}$  is covariantly conserved on  $\partial M$  when the equations of motion hold in the bulk. In fact, since  $\tau^{ij}$  is the radial conjugate momentum, it should be clear that (2.53) can also be derived directly from the equations of motion by evaluating the radial-version of the diffeomorphism constraint on  $\partial M$ . (The radial version of the Hamiltonian constraint imposes another condition on  $\tau^{ij}$  that can be used to determine the trace  $\tau = \tau^{ij} h_{ij}$  in terms of the traceless part of  $\tau^{ij}$ .)

If we now take  $\hat{\xi}$  to be a boundary Killing field, we find  $D_i(\tau^{ij} \hat{\xi}_j) = 0$ , so that the so-called Brown-York charge

$$Q_{BY}[\xi] := - \int_C \sqrt{q} n_i \tau^{ij} \hat{\xi}_j \quad (2.54)$$

is independent of the choice of Cauchy surface  $C$  in  $\partial M$ . Here  $n_i$  is a unit future-pointing normal to  $C$  and  $\sqrt{q}$  is the volume element induced on  $C$  by  $h_{ij}$ . Although

these charges were defined by methods quite different from the usual Hamiltonian techniques, we will argue in section 2.4 below that the end result is identical up to a possible choice of zero-point. Once again, the argument will turn out to be essentially the same as one would give for field theory in a fixed non-dynamical background.

Before proceeding to the AdS case, let us take a moment to consider other possible boundary conditions. We see from (2.51) that the action (2.50) also defines a valid variational principle for the boundary condition  $\tau^{ij} = 0$ . Of course, with this choice the charges (2.54) all vanish. But this should be no surprise. Since the condition  $\tau^{ij} = 0$  is invariant under *all* diffeomorphisms of  $M$ , there is no preferred subset of non-trivial asymptotic symmetries; all diffeomorphisms turn out to generate pure gauge transformations. One may also study more complicated boundary conditions by adding additional boundary terms to the action (2.50), though we will not pursue the details here.

### 2.3.2 Variational principles for scalar fields in AdS

As the reader might guess, our discussion of AlAdS gravity will follow in direct analogy to the above treatment of gravity in a box. Indeed, the only real difference is that we must work a bit harder to construct a good variational principle. We will first illustrate the relevant techniques below by constructing a variational principle for a scalar field on a fixed AdS backgroundVariational Principle, after which we will apply essentially identical techniques to AdS gravity itself in section 2.3.3.

We will construct our variational principle using the so-called counterterm

subtraction approach pioneered in [52, 53] and further developed in [45, 44]. Our discussion below largely follows [44], with minor additions from [38]. We begin with the bulk action  $S_\phi^{\text{Bulk}}$  of (2.40) and compute

$$\delta S_\phi^{\text{Bulk}} = - \int_{\partial M} \sqrt{|h|} \hat{r}^\mu \partial_\mu \phi \delta \phi, \quad (2.55)$$

where  $\hat{r}^\mu$  is the outward-pointing unit normal to  $\partial M$  so that  $\hat{r}^\mu \partial_\mu = -\frac{z}{\ell} \partial_z$ . The form of (2.55) might appear to suggest that  $S_\phi^{\text{Bulk}}$  defines a good variational principle for any boundary condition that fixes  $\phi$  on  $\partial M$ . But the appearance of inverse powers of  $z$  means that we must be more careful, and that  $S_\phi^{\text{Bulk}}$  will suffice only when  $\delta\phi$  vanishes sufficiently rapidly.

It is therefore useful to write (2.55) in terms of the finite coefficients  $\phi^{(2n)}, \phi^{(2(\nu+n))}$  of (2.42) (or the corresponding coefficients in (2.43)). The exact expression is not particularly enlightening, and for large  $\nu$  there are many singular terms to keep track of. What is useful to note however is that all of the singular terms turn out to be exact variations. In particular, using (2.44) one may show for non-integer  $\nu < 2$  that the action

$$S_\phi = S_\phi^{\text{Bulk}} + \int_{\partial M} \sqrt{|h|} \left( -\frac{\Delta_-}{2\ell} \phi^2 + \frac{\ell}{4(\nu-1)} h^{ij} \partial_i \phi \partial_j \phi \right) \quad (2.56)$$

satisfies

$$\delta S_\phi = 2\nu \ell^{d-1} \int_{\partial M} \sqrt{|\gamma^{(0)}|} \phi^{(2\nu)} \delta \phi^{(0)}. \quad (2.57)$$

Since the boundary terms in (2.56) are each divergent in and of themselves, they are known as counterterms in analogy with the counterterms used to cancel ultraviolet divergences in quantum field theory. These divergences cancel against

divergences in  $S_\phi^{\text{Bulk}}$  and the full action  $S_\phi$  is finite for any field of the form (2.42) with non-integer  $\nu < 2$ . Similar results hold for non-integer  $\nu > 2$  if additional higher-derivative boundary terms are included in (2.56). We will comment on differences for integer  $\nu$  at the end of this section.

It is clear that  $S_\phi$  provides a good variational principle so long as the boundary conditions either fix  $\phi^{(0)}$  or set  $\phi^{(2\nu)} = 0$ . We may now identify

$$\Phi_{\text{bdy}} := 2\nu\ell^{d-1}\phi^{(2\nu)} \quad (2.58)$$

as an AdS scalar response function analogous to the boundary stress tensor  $\tau^{ij}$  introduced in section 2.3.1. Note that adding an extra boundary term  $\int \sqrt{\gamma^{(0)}}W[\phi^{(0)}]$  to  $S_\phi$  allows one to instead use the Robin-like boundary condition

$$\phi^{(2\nu)} = -\frac{\ell}{2\nu}W'[\phi^{(0)}], \quad (2.59)$$

where  $W'$  denotes the derivative of  $W$  with respect to its argument.

Recall from section 2.2.6 that requiring the energy to be bounded below restricts  $\nu$  to be real (in which case we take  $\nu$  non-negative). That there are further implications for large  $\nu$  can also be seen from (2.56). Note that the final term in (2.56) is a kinetic term on  $\partial M$  and that for  $\nu > 1$  it has a sign *opposite* to that of the bulk kinetic term. Counting powers of  $z$  shows that this boundary kinetic term vanishes at  $\partial M$  for  $\nu < 1$ , but contributes for  $\nu > 1$ . In this case, for any perturbation that excites  $\phi^{(0)}$  and which is supported sufficiently close to  $\partial M$ , the boundary kinetic term in (2.56) turns out to be more important than the bulk kinetic term. Thus the perturbation has negative kinetic energy. One says



that the theory contains ghosts, and any conserved energy is expected to be unbounded below [38]. For this reason, for  $\nu > 1$  one typically allows only boundary conditions that fix  $\phi^{(0)}$ . Of course, as noted in section 2.3.2, for  $\nu > d/2$  coupling the theory to dynamical gravity and requiring the spacetime to be AlAdS will further require  $\phi^{(0)} = 0$ . On the other hand, for real  $0 < \nu < 1$  all of the above boundary conditions lead to ghost-free scalar theories.

The story of non-integer  $\nu > 2$  is much the same as that of  $\nu \in (1, 2)$ . Adding additional higher-derivative boundary terms to (2.56) again leads to an action that satisfies (2.57). While one can find actions compatible with general boundary conditions (2.59), the only ghost-free theories fix  $\phi^{(0)}$  on  $\partial M$ . The story of integer  $\nu$  is more subtle; the factors of  $\ln z$  arising in that case from (2.43) mean that we can find a good variational principle only by including boundary terms that depend explicitly on the defining function  $\Omega$  of the chosen conformal frame. Doing so again leads to ghosts unless  $\phi^{(0)}$  is fixed as a boundary condition [38].

### 2.3.3 A variational principle for AlAdS gravity

We are now ready to construct our variational principle for AlAdS gravity Variational Principle. As for the scalar field above, we will start with a familiar bulk action and then add boundary terms. One may note that in the scalar case our final action (2.56) consists essentially of adding boundary terms to  $S_\phi^{\text{Bulk}}$  which i) are written as integrals of local scalars built from  $\phi$  and its tangential derivatives along  $\partial M$  and ii) precisely cancel divergent terms in  $S_\phi^{\text{Bulk}}$ . This motivates us to follow the strategy of [45] for the gravitational case in which we first identify divergent terms in a familiar action and write these terms as local scalars on  $\partial M$ .

We may then construct a finite so-called renormalized action by adding boundary counterterms on  $\partial M$  to cancel the above divergences. At the end of this process we may check that this renormalized action yields a good variational principle for interesting boundary conditions. In analogy with section (2.3.1), for simplicity in the remainder of this chapter we take the induced (conformal) metric on  $\partial M$  to be globally hyperbolic with compact Cauchy surfaces.

Let us begin with an action containing the standard Einstein-Hilbert and cosmological constant terms in the bulk, along with the Gibbons-Hawking term. It will facilitate our discussion of divergent terms to consider a regulated action in which the boundary has effectively been moved in to  $z = \epsilon$ . For the moment, we choose some  $\epsilon_0 > \epsilon$  and impose the Fefferman-Graham gauge (2.17) for all  $z < \epsilon_0$ , so that this gauge holds in particular at the regulated boundary. This gauge fixing at finite  $z$  is merely an intermediate step to simplify the analysis. We will be able to loosen this condition once we have constructed the final action. We let  $h_{ij} = (\ell/z)^2 \gamma_{ij}|_{z=\epsilon}$  be the induced metric on this regulated boundary and study the action

$$\begin{aligned} S_{\text{reg}} &= \frac{1}{2\kappa} \int_{z \geq \epsilon} \sqrt{|g|} (R - 2\Lambda) - \frac{1}{\kappa} \int_{z=\epsilon} \sqrt{|h|} K \\ &= -\frac{\ell^{d-1}}{2\kappa} \int_{z=\epsilon} \sqrt{|\gamma^{(0)}|} (\epsilon^{-d} a_{(0)} + \epsilon^{-d+2} a_{(2)} + \cdots + \epsilon^{-2} a_{(d-2)} - \log(\epsilon^2) a_{(d)}) + (\text{finite}), \end{aligned} \quad (2.60)$$

where  $K = h_{ij} K^{ij}$  is the trace of the extrinsic curvature of the regulated boundary  $\partial M_\epsilon$  at  $z = \epsilon$  and the form of the divergences follows from (2.21). The coefficient  $a_{(d)}$  vanishes for odd  $d$ . For even  $d$  it is called the conformal anomaly for reasons to be explained below.

In analogy with the scalar field results of section 2.3.2, one finds that the coefficients  $a_{(n)}$  which characterize the divergent terms are all local scalars built from  $\gamma_{ij}^{(0)}$  and its derivatives along  $\partial M$ . This follows directly from the fact that all terms  $\gamma^{(n)}$  with  $n \leq d$  in the Fefferman-Graham expansion (2.21) are local functions of  $\gamma_{ij}^{(0)}$  and its derivatives along  $\partial M$ . Dimensional analysis shows that  $a_{(n)}$  involves precisely  $2n$  derivatives and the detailed coefficients  $a_{(n)}$  can be found to any desired order by direct calculation. For example, for  $n \neq d$  the  $a_{(n)}$  are given by (see e.g. [45])

$$\begin{aligned} a_{(0)} &= -2(d-1), & a_{(2)} &= \frac{(d-4)}{2(d-2)}\mathcal{R}, \\ a_{(4)} &= -\frac{d^2-9d+16}{4(d-4)} \left( \frac{d\mathcal{R}^2}{4(d-2)^2(d-1)} - \frac{\mathcal{R}^{ij}\mathcal{R}_{ij}}{(d-2)^2} \right), & \dots, \end{aligned} \quad (2.61)$$

where as in section 2.2.4,  $\mathcal{R}$  and  $\mathcal{R}_{ij}$  are the Ricci scalar and Ricci tensor of  $\gamma^{(0)}$  on  $\partial M$ . For  $d = 2, 4$ , the log terms are given by

$$\begin{aligned} d=2: & \quad a_{(2)} = -\frac{\mathcal{R}}{2}, \\ d=4: & \quad a_{(4)} = \left( \frac{\mathcal{R}^2}{24} - \frac{\mathcal{R}^{ij}\mathcal{R}_{ij}}{8} \right). \end{aligned} \quad (2.62)$$

As foreshadowed above, we now define the renormalized action

$$S_{\text{ren}} = \lim_{\epsilon \rightarrow 0} (S_{\text{reg}} + S_{\text{ct}}), \quad (2.63)$$

where

$$S_{\text{ct}} := \frac{\ell^{d-1}}{2\kappa} \int_{z=\epsilon} \sqrt{-\gamma^{(0)}} \left( \epsilon^{-d} a_{(0)} + \epsilon^{-d+2} a_{(2)} + \cdots + \epsilon^{-2} a_{(d-2)} - \log(\epsilon^2) a_{(d)} \right) \quad (2.64)$$

is constructed to precisely cancel the divergent terms in  $S_{\text{ren}}$ . The representation (2.64) makes the degree of divergence in each term manifest. But the use of  $\epsilon$  in defining  $S_{\text{ct}}$  suggests a stronger dependence on the choice of defining function  $\Omega$  (and thus, on the choice of conformal frame) than is actually the case. To understand the true dependence, we should use the Fefferman-Graham expansion to instead express  $S_{\text{ct}}$  directly in terms of the (divergent) metric  $h$  induced on  $\partial M$  by the unrescaled bulk metric  $g$  as was done in [53]. Dimensional analysis and the fact that each  $a_{(n)}$  involves precisely  $2n$  derivatives shows that this removes all explicit dependence on  $\epsilon$  save for the logarithmic term in even  $d$ . In particular, formally taking  $\epsilon$  to zero we may write

$$S_{\text{ct}} = \frac{\ell}{2\kappa} \int_{\partial M} \sqrt{|h|} \left[ -\frac{2(d-1)}{\ell^2} - \frac{\mathcal{R}_h}{(d-2)} + \cdots - \frac{\epsilon^d \log(\epsilon^2) a_{(d)}}{\ell^2} \right], \quad (2.65)$$

where the  $\mathcal{R}_h$  (Ricci scalar of  $h$ ) term only appears for  $d \geq 3$  and the dots represent additional terms that appear only for  $d \geq 5$ .

In general, the coefficients in (2.65) differ from those in (2.60) due to sub-leading divergences in a given term in (2.65) contributing to the coefficients of seemingly lower-order terms in (2.60). But the logarithmic term has precisely the same coefficient  $a_{(d)}$  in both (2.65) and (2.60). Since the logarithmic term in (2.21) is multiplied by  $z^d$ , only the leading  $-\frac{2(d-1)}{\ell^2} \sqrt{|h|}$  term in (2.65) could contribute

to any discrepancy. But the first variation of a determinant is a trace, and the trace of the logarithmic coefficient  $\bar{\gamma}_{ij}^{(d)}$  vanishes by (2.22).

Thus for  $d$  odd (where the log term vanishes) the renormalized action  $S_{\text{ren}}$  can be expressed in a fully covariant form in terms of the physical metric  $g$ ; all dependence on the defining function  $\Omega$  (and so on the choice of conformal frame) has disappeared. We therefore now drop the requirement that any Fefferman-Graham gauge be imposed for odd  $d$ . But for even  $d$ , the appearance of  $\log(\epsilon^2)$  in (2.65) indicates that  $S_{\text{ren}}$  does in fact depend on the choice of defining function  $\Omega$  (and thus on the choice of conformal frame). In analogy with quantum field theory, this dependence is known as the conformal anomaly. By replacing  $\epsilon$  with  $\Omega$  in (2.65), we could again completely drop the requirement of Fefferman-Graham gauge in favor of making explicit the above dependence on  $\Omega$ . However, an equivalent procedure is to require that the expansion (2.21) hold up through order  $\gamma^{(d)}$  and to replace  $\epsilon$  in (2.65) by the Fefferman-Graham coordinate  $z$ . We will follow this latter approach (which is equivalent to imposing Fefferman-Graham gauge only on the stated terms in the asymptotic expansion) as it is more common in the literature.

We are finally ready to explore variations of  $S_{\text{ren}}$ . Since  $S_{\text{ren}}$  was constructed by adding only boundary terms to the usual bulk action, we know that  $\delta S_{\text{ren}}$  must be a pure boundary term on solutions. As before, we will discard boundary terms in the far past and future of  $M$  and retain only the boundary term at  $\partial M$ . Since  $\partial M$  is globally hyperbolic with compact Cauchy surfaces, performing integrations by parts on  $\partial M$  will yield boundary terms only in the far past and future of  $\partial M$ .

Discarding these as well allows us to write

$$\delta S_{\text{ren}} = \int_{\partial M} S^{\mu\nu} \delta g_{\mu\nu}, \quad (2.66)$$

for some  $S^{\mu\nu}$ . But let us now return to Fefferman-Graham gauge and use it to expand  $\delta g_{\mu\nu}$  as in (2.21). Since  $S_{\text{ren}}$  is finite,  $\delta S_{\text{ren}}$  must be finite as well. But the leading term in  $\delta g_{\mu\nu}$  is of order  $z^{-2}$ . So the leading term in  $S_{\mu\nu}$  must be of order  $z^2$ . It follows that only these leading terms can contribute to (2.66). Since the leading term in  $\delta g_{\mu\nu}$  involves  $\delta\gamma_{ij}^{(0)}$ , we may write

$$\delta S_{\text{ren}} = \frac{1}{2} \int_{\partial M} \sqrt{|\gamma^0|} T_{\text{bdy}}^{ij} \delta\gamma_{ij}^{(0)} \quad (2.67)$$

for some finite so-called boundary stress tensor  $T_{\text{bdy}}^{ij}$  on  $\partial M$ . For odd  $d$ , the fact that  $S_{\text{ren}}$  is invariant under arbitrary changes of conformal frame  $\delta\gamma_{ij}^{(0)} = e^{-2\sigma} \gamma_{ij}^{(0)}$  immediately implies that the boundary stress tensor is traceless:  $T_{\text{bdy}} := \gamma_{ij}^{(0)} T_{\text{bdy}}^{ij} = 0$ . In even dimensions, the trace is determined by the conformal anomaly of  $S_{\text{ren}}$  (i.e., by the logarithmic term in either (2.60) or (2.65)) and one finds

$$T_{\text{bdy}} = -\frac{\ell^{d-1}}{\kappa} a_{(d)}. \quad (2.68)$$

This result may also be derived by considering the radial version of the Hamiltonian constraint and evaluating this constraint at  $\partial M$ .

Comparing with section 2.3.1, it is clear that we may write

$$T_{\text{bdy}}^{ij} = \lim_{\epsilon \rightarrow 0} \left( \frac{\ell}{\epsilon} \right)^{d+2} (\tau^{ij} + \tau_{ct}^{ij}), \quad (2.69)$$

where again  $\tau_{ij} = \kappa^{-1}(K_{ij} - Kh_{ij})$  and the new term  $\tau_{\text{ct}}^{ij}$  comes from varying  $S_{\text{ct}}$ .

In Fefferman-Graham gauge one finds by explicit calculation that for  $d$  odd

$$T_{\text{bdy}}^{ij} = \frac{d\ell^{d-1}}{2\kappa} \gamma^{(d)ij}. \quad (2.70)$$

For  $d$  even there are extra contributions associated with the conformal anomaly, which are thus all determined by  $\gamma^{(0)}$ ; e.g. (see [45])

$$\text{for } d = 2: \quad T_{\text{bdy}}^{ij} = \frac{\ell}{\kappa} \left( \gamma^{(2)ij} + \frac{1}{2} \mathcal{R} \gamma^{(0)ij} \right) \quad (2.71)$$

$$\text{for } d = 4: \quad T_{\text{bdy}}^{ij} = \frac{2\ell^3}{\kappa} \left[ \gamma^{(4)ij} - \frac{1}{8} \left( (\gamma^{(2)})^2 - \gamma^{(2)kl} \gamma_{kl}^{(2)} \right) \gamma^{(0)ij} - \frac{1}{2} \gamma^{(2)ik} \gamma_{k \quad j}^{(2)} + \frac{1}{4} \gamma^{(2)} \gamma^{(2)ij} + \frac{3}{2} \bar{\gamma}^{(4)ij} \right], \quad (2.72)$$

where  $\gamma^{(2)}$ ,  $\bar{\gamma}^{(4)}$  are given by (2.19), (2.23), (2.24). In all cases, we see that we may use  $\gamma_{ij}^{(0)}, T_{\text{bdy}}^{ij}$  to parametrize the free data in the Fefferman-Graham expansion.

The reader should note that the particular value of  $T_{\text{bdy}}^{ij}$  on a given solution depends on the choice of a representative  $\gamma^{(0)}$  and thus on the choice of conformal frame. For  $d$  odd this dependence is a simple scaling, though it is more complicated for  $d$  even.

But this does not diminish the utility of  $T_{\text{bdy}}^{ij}$ . For example, we see immediately from (2.67) that  $S_{\text{ren}}$  defines a good variational principle whenever i)  $\gamma^{(0)}$  is fixed as a boundary condition or ii)  $d$  is odd, so that  $T_{\text{bdy}}^{ij}$  is traceless, and we fix only the conformal class of  $\gamma^{(0)}$ .

We close this section with some brief comments on other possible boundary conditions. We see from (2.67) that  $S_{\text{ren}}$  is also a good variational principle if

we fix  $T_{\text{bdy}}^{ij} = 0$ . As in section 2.3.2, one may obtain variational principles for more complicated boundary conditions by adding further finite boundary terms to (2.65); see [54] for details. However, just as for scalar fields with  $\nu > 1$ , boundary conditions that allow  $\gamma^{(0)}$  to vary generally lead to ghosts [38] (with the exception that, for  $d$  odd no ghosts arise from allowing  $\gamma^{(0)}$  to vary by a conformal factor). For this reason we consider below only boundary conditions that fix  $\gamma^{(0)}$ , or at least its conformal class for  $d$  odd.

### 2.3.4 Conserved Charges for AlAdS gravity

We are now ready to apply the Brown-York-type procedure discussed in section 2.3.1 to construct conserved charges for AlAdS gravity. The key step is again an argument analogous to (2.52) to show conservation of  $T_{\text{bdy}}^{ij}$  on  $\partial M$ . We give the derivation here in full to highlight various subtleties of the AdS case. We also generalize the result slightly by coupling the AlAdS gravity theory of section 2.3.3 to the scalar theory of section 2.3.2. For definiteness we assume that the boundary conditions fix both  $\gamma^{(0)}$  and  $\phi^{(0)}$  (up to conformal transformations  $(\gamma_{ij}^{(0)}, \phi^{(0)}) \rightarrow (e^{-2\sigma}\gamma_{ij}^{(0)}, e^{\Delta-\sigma}\phi^{(0)})$ ) for odd  $d$ , where the transformation of  $\phi^{(0)}$  is dictated by (2.42) and we take  $\nu$  non-integer so that no log terms arise from the scalar field. However, the more general case is quite similar [37, 54].

We thus consider the action  $S_{\text{total}} = S_{\text{ren}} + S_{\phi}$ . The reader should be aware that, because the counterterms in  $S_{\phi}$  explicitly depend on the boundary metric  $\gamma^{(0)}$ , this coupling to matter will change certain formulae in section 2.3.3. In



particular, if we now make the natural definition

$$T_{\text{bdy}}^{ij} = \frac{2}{\sqrt{|\gamma^{(0)}|}} \frac{\delta S_{\text{total}}}{\delta \gamma_{ij}^{(0)}}, \quad (2.73)$$

varying the action under a boundary conformal transformation leads to the more general condition

$$T_{\text{bdy}} - \Delta_- \Phi_{\text{bdy}} \phi^{(0)} = -\frac{\ell^{d-1} a_{(d)}}{\kappa}, \quad (2.74)$$

which reduces to the trace constraint of section 2.3.3 only for  $\Phi_{\text{bdy}} = 0$ ,  $\phi^{(0)} = 0$ , or  $\Delta_- = 0$ . Recall that  $\Phi_{\text{bdy}}$  is given by (2.58).

The coupling to  $S_\phi$  similarly modifies the divergence condition (2.52) of section 2.3.1. Using the definition (2.73), we find

$$\delta S_{\text{total}} = \int_{\partial M} \sqrt{|\gamma^{(0)}|} \left( \frac{1}{2} T_{\text{bdy}}^{ij} \delta \gamma_{ij}^{(0)} + \Phi_{\text{bdy}} \delta \phi^{(0)} \right). \quad (2.75)$$

Let us consider the particular variation associated with a bulk diffeomorphism  $\xi$ . It is sufficient here to consider bulk diffeomorphisms compatible with whatever defining function  $\Omega$  we have used to write (2.75); i.e., for which  $\mathcal{L}_\xi \Omega = 0$ . As described in section 2.2.5, other diffeomorphisms differ only in that they also induce a change of conformal frame. Since we already extracted the information about  $T_{\text{bdy}}^{ij}$  (and in particular, about its trace) that can be obtained by changing conformal frame in section 2.3.3, we lose nothing by restricting here to vector fields with  $\mathcal{L}_\xi \Omega = 0$ .

As described in section 2.2.5, we then find  $\delta \gamma^{(0)} = \mathcal{L}_\xi \gamma^{(0)}$ ,  $\delta \phi^{(0)} = \mathcal{L}_\xi \phi^{(0)}$ ,

where  $\hat{\xi}$  is the vector field induced by  $\xi$  on  $\partial M$ . Thus (2.75) reads

$$\begin{aligned} \delta_\xi S_{\text{ren}} = 0 &= \int_{\partial M} \sqrt{|\gamma^{(0)}|} \left( T^{ij} D_i \hat{\xi}_j + \frac{\delta S_{\text{ren}}}{\delta \phi^{(0)}} \mathcal{L}_\xi \phi^{(0)} \right) \\ &= - \int_{\partial M} \sqrt{|\gamma^{(0)}|} \hat{\xi}_j (D_i T^{ij} - \Phi_{\text{bdy}} D^j \phi^{(0)}), \end{aligned} \quad (2.76)$$

where  $D_i$  is again the covariant derivative on  $\partial M$  compatible with  $\gamma^{(0)}$ , all indices are raised and lowered with  $\gamma^{(0)}$ , and we have dropped the usual surface terms in the far past and future of  $\partial M$ . Recalling that all  $\hat{\xi}^i$  can arise from bulk vector fields  $\xi$  compatible with any given  $\Omega$ , we see that (2.76) must hold for any  $\hat{\xi}_j$ . Thus,

$$D_i T_{\text{bdy}}^{ij} = \Phi_{\text{bdy}} D^j \phi^{(0)}; \quad (2.77)$$

i.e.,  $T_{\text{bdy}}^{ij}$  is conserved on  $\partial M$  up to terms that may be interpreted as scalar sources. These sources are analogous to sources for the stress tensor of, say, a scalar field on a fixed spacetime background when the scalar field is also coupled to some background potential. Here the role of the background potential is played by  $\phi^{(0)}$ , which we have fixed as a boundary condition. As in section 2.3.1, the divergence condition (2.77) may also be derived from the radial version of the diffeomorphism constraint evaluated on  $\partial M$ . For  $\phi^{(0)} = 0$  and  $d$  odd one immediately arrives at (2.20) using (2.77) and (2.70).

We wish to use (2.77) to derive conservation laws for asymptotic symmetries. Here it is natural to say that a diffeomorphism  $\xi$  of  $M$  is an asymptotic symmetry if there is *some* conformal frame in which the induced vector field  $\hat{\xi}$  on  $\partial M$  is i)

a Killing field of  $\gamma^{(0)}$  and ii) a solution of  $\mathcal{L}_\xi \phi^{(0)} = 0$ . Due to the transformations of  $\gamma^{(0)}, \phi^{(0)}$  under boundary conformal transformations, this is completely equivalent to first choosing an arbitrary conformal frame and then requiring

$$\mathcal{L}_{\hat{\xi}} \gamma_{ij}^{(0)} = -2\sigma \gamma_{ij}^{(0)}, \quad \mathcal{L}_{\hat{\xi}} \phi^{(0)} = \Delta_- \sigma \phi^{(0)}. \quad (2.78)$$

The first requirement says that  $\hat{\xi}$  is a conformal Killing field of  $\gamma_{ij}^{(0)}$  with  $\frac{1}{d} D_i \hat{\xi}^i = -\sigma$  and the second says that it acts on  $\phi^{(0)}$  like the corresponding infinitesimal conformal transformation.

For even  $d$ , we must also preserve the boundary condition that  $\gamma^{(0)}$  be fixed (even including the conformal factor) and the requirement of section (2.3.3) that Fefferman-Graham gauge hold to the first few orders in the asymptotic expansion. An analysis similar to that of section 2.2.5 then shows that we must have  $\xi^z = \frac{z}{d} D_i \hat{\xi}^i$  to leading order near  $\partial M$ . In particular, for  $D_i \hat{\xi}^i \neq 0$  an asymptotic symmetry  $\xi$  must be non-compatible with  $\Omega$  is just the right way to leave  $\gamma^{(0)}$  invariant.

As a side comment, we mention that the trivial asymptotic symmetries (the pure gauge transformations) are just those with  $\hat{\xi} = 0$ . This means that they act trivially on both  $T_{\text{bdy}}^{ij}$  and  $\Phi_{\text{bdy}}$  of section 2.3.2, so that both  $T_{\text{bdy}}^{ij}$  and the  $\Phi_{\text{bdy}}$  are gauge invariant. This conclusion is obvious in retrospect as these response functions are functional derivatives of the action with respect to the boundary conditions  $\gamma_{ij}^{(0)}$  and  $\phi^{(0)}$ . Since both the action and any boundary conditions are gauge invariant by definition, so too must be the functional derivatives  $T_{\text{bdy}}^{ij}$  and  $\Phi_{\text{bdy}}$ .

Returning to our construction of charges in AdS spacetimes, note that for any asymptotic symmetries as above we may compute

$$D_i(T_{\text{bdy}}^{ij} \hat{\xi}_j) = -\sigma(T_{\text{bdy}} - \Delta_- \Phi_{\text{bdy}} \phi^{(0)}) = \sigma \frac{\ell^{d-1} a_{(d)}}{\kappa}, \quad (2.79)$$

where in the final step we have used (2.74).

In analogy with section 2.3.1, we now consider the charges

$$Q[\xi] = - \int_C \sqrt{q} n_i T_{\text{bdy}}^{ij} \xi_j, \quad (2.80)$$

where  $C$  is a Cauchy surface of  $\partial M$ ,  $\sqrt{q}$  is the volume element induced on  $C$  by  $\gamma^{(0)}$ , and  $n^i$  is the unit future pointing normal to  $C$  with respect to  $\gamma^{(0)}$ . It follows from (2.79) that these charges can depend on  $C$  only through a term built from the conformal anomaly  $a_{(d)}$ .

It is now straightforward to construct a modified charge  $\tilde{Q}[\xi]$  which is completely independent of  $C$ . The essential point here is to recall that  $a_{(d)}$  depends only on the boundary metric  $\gamma^{(0)}$ . Since we have fixed  $\gamma^{(0)}$  as a boundary condition, the dependence on  $C$  is the same for any two allowed solutions. Thus on a given solution  $s$  we need only define

$$\tilde{Q}[\xi](s) = Q[\xi](s) - Q[\xi](s_0), \quad (2.81)$$

where  $s_0$  is an arbitrary reference solution satisfying the same boundary condition and which we use to set the zero-point. The construction (2.81) is sufficiently trivial that one often refers to  $Q[\xi]$  itself as being conserved.

Our construction of the charges  $Q[\xi]$ ,  $\tilde{Q}[\xi]$  depended on the choice of some conformal frame. But it is easy to see that the charges are in fact independent of this choice for  $d$  odd. In that case, the factors  $\sqrt{q}$ ,  $n_i$ , and  $T_{\text{bdy}}^{ij}$  all simply scale under a boundary conformal transformation and dimensional analysis shows that the combination (2.80) is invariant. For even  $d$  there are additional terms in the transformation of  $T_{\text{bdy}}^{ij}$ . But as usual these depend only on  $\gamma^{(0)}$  so that they cancel between the two terms in (2.81). Thus even in this case for fixed  $s_0$  the charges (2.81) are independent of the conformal frame.

To make the above procedure seem more concrete, we now quickly state results for the AdS<sub>3</sub> and AdS<sub>4</sub> Schwarzschild solutions

$$ds^2 = - \left( 1 - \frac{2c_d GM}{\rho^{d-2}} + \frac{\rho^2}{\ell^2} \right) d\tau^2 + \frac{d\rho^2}{1 - \frac{2c_d GM}{\rho^{d-2}} + \frac{\rho^2}{\ell^2}} + \rho^2 d\Omega_{(d-2)}^2, \quad (2.82)$$

where  $c_3 = 1$  and  $c_4 = \frac{4}{3\pi}$ . The boundary stress tensor may be calculated by converting to Fefferman-Graham coordinates, say for the conformal frame defined by  $\Omega = \rho^{-1}$ . (Note that the Fefferman-Graham radial coordinate  $z$  will agree with  $\rho$  only at leading order.) One then finds the energy

$$Q[-\partial_\tau] = \begin{cases} M, & d = 3 \\ M + \frac{3\pi\ell^2}{32G}, & d = 4, \end{cases} \quad (2.83)$$

where we remind the reader that energies  $E = -Q[\partial_\tau] = Q[-\partial_\tau]$  are conventionally defined in this way with an extra minus sign to make them positive. We see that for  $d = 3$  we recover the expected result for the energy of the spacetime. For  $d = 4$  we also recover the expected energy up to a perhaps unfamiliar choice of

zero-point which we will discuss further in section 2.4.4.

### 2.3.5 Positivity of the energy in AlAdS gravity

Thus far we have treated all charges  $Q[\xi]$  on an equal footing. But when  $\hat{\xi}$  is everywhere timelike and future-directed on  $\partial M$ , it is natural to call  $E = Q[-\xi]$  an *energy* asymptotically locally AdS and to wonder if  $E$  is bounded below. Such a result was established for the ADM energy of asymptotically flat spacetimes, and the Witten spinor methods [55, 56] discussed there generalize readily to asymptotically AdS (AAdS) spacetimes so long as the matter fields satisfy the dominant energy condition and decay sufficiently quickly at  $\partial M$  [57]. In particular, this decay condition is satisfied for the scalar field of section 2.3.2 with  $m^2 \geq m_{BF}^2$  when  $\phi^{(0)}$  is fixed as a boundary condition. Extensions to more general scalar boundary conditions can be found in [58, 59, 60, 61, 62]. Here the details of the boundary conditions are important, as boundary conditions for which the  $W$  of (2.59) diverges sufficiently strongly in the negative direction tend to make any energy unbounded below (see e.g. [63] for examples). This is to be expected from the fact that, as discussed in section 2.3.2, this  $W$  represents an addition to the Lagrangian and thus to any Hamiltonian, even if only as a boundary term. As for  $\Lambda = 0$ , the above AAdS arguments were inspired by earlier arguments based on quantum supergravity (see [64, 65] for the asymptotically flat case and [32] for the AAdS case).

The above paragraph discussed only AAdS spacetimes. While the techniques described there can also be generalized to many AlAdS settings, it is not possible to proceed in this way for truly general choices of  $M$  and  $\partial M$ . The issue is

that the methods of [55, 56] require one to find a spinor field satisfying a Dirac-type equation subject to certain boundary conditions. But for some  $M, \partial M$  one can show that no solution exists. In particular, this obstruction arises when  $\partial M = S^1 \times \mathbb{R}^{d-1}$  and the  $S^1$  is contractible in  $M$  [66].

The same obstruction also arises with zero cosmological constant in the context of Kaluza-Klein theories (where the boundary conditions may again involve an  $S^1$  that is contractible in the bulk). In that case, the existence of so-called bubbles of nothing demonstrates that the energy is in fact unbounded below and that the system is unstable even in vacuum [67, 68]. But what is interesting about the AlAdS context with  $\partial M = S^1 \times \mathbb{R}^{d-1}$  is that there are good reasons [66] to believe that the energy *is* in fact bounded below – even if there are there are some solutions with energy lower than what one might call empty AdS with  $\partial M = S^1 \times \mathbb{R}^{d-1}$  (by which we mean the quotient of the Poincaré patch under some translation of the  $x^i$ ). Perhaps the strongest such argument (which we will not explain here) comes from AdS/CFT. But another is that [69] identified a candidate lowest-energy solution (called the AdS soliton) which was shown [66] to at least locally minimize the energy. Proving that the AdS soliton is the true minimum of the energy, or falsifying the conjecture, remains an interesting open problem whose solution appears to require new techniques.

## 2.4 Relation to Hamiltonian Charges

We have shown that the charges (2.81) are conserved and motivated their definition in analogy with familiar constructions for field theory in a fixed curved

spacetime. But it is natural to ask whether the charges (2.81) in fact agree with more familiar Hamiltonian definitions of asymptotic charges constructed, say, using the AdS generalization of the Hamiltonian approach. Denoting these latter charges  $H[\xi]$ , the short answer is that they agree so long as we choose  $s_0$  in (2.81) to satisfy  $H[\xi](s_0) = 0$ ; i.e., they agree so long as we choose the same (in principle arbitrary) zero-point for each notion of charge. We may equivalently say that the difference  $Q[\xi] - H[\xi]$  is the same for all solutions in our phase space, though for conformal charges it may depend on the choice of Cauchy surface  $C$  for  $\partial M$ . As above, for simplicity we take  $\partial M$  to be globally hyperbolic with compact Cauchy surfaces.

This result may be found by direct computation (see [70] for simple cases). But a more elegant, more general, and more enlightening argument can be given [37] using a covariant version of the Poisson bracket known as the Peierls bracket [71]. The essence of the argument is to show that  $Q[\xi]$  generates the canonical transformations associated with the diffeomorphisms  $\xi$ . This specifies all Poisson brackets of  $Q[\xi]$  to be those of  $H[\xi]$ . Thus  $Q[\xi] - H[\xi]$  must be a c-number in the sense that all Poisson brackets vanish. But this means that it is constant over the phase space.

After pausing to introduce the Peierls bracket, we sketch this argument below following [37]. As in section 2.3.4, we suppose for simplicity that the only bulk fields are the metric and a single scalar field with non-integer  $\nu$  and we impose boundary conditions that fix both  $\gamma_{ij}^{(0)}$  and  $\phi^{(0)}$ . However, the argument for general bulk fields is quite similar [37]. While this material represents a certain aside from our main discussion, it will provide insight into the algebraic properties of



conserved charges, the stress tensor itself, and a more general notion of so-called boundary observables that we will shortly discuss.

### 2.4.1 The Peierls bracket

The Peierls bracket is a Lie bracket operation that acts on gauge-invariant functions on the space of solutions  $\mathcal{S}$  of some theory. As shown in the original work [71], this operation is equivalent to the Poisson bracket under the natural identification of the phase space with the space of solutions. However, the Peierls bracket is *manifestly* spacetime covariant. In particular, one may directly define the Peierls bracket between any two quantities  $A$  and  $B$  located anywhere in spacetime, whether or not they may be thought of as lying on the same Cauchy surface. In fact, both  $A$  and  $B$  can be highly non-local, extending over large regions of space and time. These features make the Peierls bracket ideal for studying the boundary stress-tensor, which is well-defined on the space of solutions but is not a local function in the bulk spacetime.

To begin, consider two functions  $A$  and  $B$  on  $\mathcal{S}$ , which are in fact defined as functions on a larger space  $\mathcal{H}$ , which we call the space of histories. This space  $\mathcal{H}$  is the one on which the action is defined; i.e., the solution space  $\mathcal{S}$  consists of those histories in  $\mathcal{H}$  on which the action  $S$  is stationary. One may show that the Peierls bracket on  $\mathcal{S}$  depends only on  $A, B$  on  $\mathcal{S}$  and not on their extensions to  $\mathcal{H}$ .

The Peierls bracket is defined by considering the effect on one gauge invariant function (say,  $B$ ) when the action is deformed by a term proportional to another such function ( $A$ ). One defines the advanced ( $D_A^+ B$ ) and retarded ( $D_A^- B$ ) effects of  $A$  on  $B$  by comparing the original system with a new system given by the

action  $S_\epsilon = S + \epsilon A$ , but associated with the same space of histories  $\mathcal{H}$ . Here  $\epsilon$  is a real parameter which will soon be taken to be infinitesimal, and the new action is associated with a new space  $\mathcal{S}_\epsilon$  of deformed solutions.

Under retarded (advanced) boundary conditions for which the solutions  $s \in \mathcal{S}$  and  $s_\epsilon \in \mathcal{S}_\epsilon$  coincide in the past (future) of the support of  $A$ , the quantity  $B_0 = B(s)$  computed using the undeformed solution  $s$  will in general differ from  $B_\epsilon^\pm = B(s_\epsilon)$  computed using  $s_\epsilon$  and retarded ( $-$ ) or advanced ( $+$ ) boundary conditions (see Fig. 2.4). For small epsilon, the difference between these quantities defines the retarded (advanced) effect  $D_A^- B$  ( $D_A^+ B$ ) of  $A$  on  $B$  through:

$$D_A^\pm B = \lim_{\epsilon \rightarrow 0} \frac{1}{\epsilon} (B_\epsilon^\pm - B_0), \quad (2.84)$$

which is a function of the unperturbed solution  $s$ . Similarly, one defines  $D_B^\pm A$  by reversing the roles of  $A$  and  $B$  above. Since  $A, B$  are gauge invariant,  $D_B^\pm A$  is a well-defined (and again gauge-invariant) function on the space  $\mathcal{S}$  of solutions so long as both  $A$  and  $B$  are first-differentiable on  $\mathcal{H}$ . This requirement may be subtle if the spacetime supports of  $A$  and  $B$  extend into the far past and future, but is straightforward for objects like  $T_{\text{bdy}}^{ij}(x)$ ,  $\Phi_{\text{bdy}}(x)$  that are well-localized in time.

The Peierls bracket [71] is then defined to be the difference of the advanced and retarded effects:

$$\{A, B\} = D_A^+ B - D_A^- B. \quad (2.85)$$

As shown in [71], this operation agrees with the Poisson bracket (suitably generalized to allow  $A, B$  at unequal times). This generalizes the familiar result

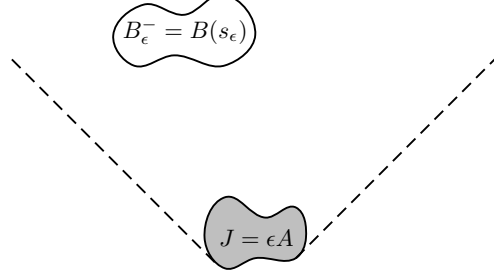

Figure 2.4: An illustration of the definition of  $B_\epsilon^-$ . A source term  $J = \epsilon A$  is added to the action and the gauge invariant function  $B$  is calculated for the deformed solution  $s_\epsilon$  subject to the boundary conditions that  $s$  and  $s_\epsilon$  coincide in the far past. Dashed lines indicate the boundary of the causal future of  $J$ . Only functions  $B$  which have support in this region can have  $B(s_\epsilon) \neq B(s)$ . For visual clarity we have chosen our gauge invariant function  $A$  and  $B$  to have compact support though this is not required.

that the commutator function for a free scalar field is given by the difference between the advanced and retarded Green's functions. In fact, it is enlightening to write the Peierls bracket more generally in terms of such Green's functions. To do so, let us briefly introduce the notation  $\phi^I$  for a complete set of bulk fields (including the components of the bulk metric) and the associated advanced and retarded Green's functions  $G_{IJ}^\pm(x, x')$ . Note that we have

$$D_A^+ B = \int dx dx' \frac{\delta B}{\delta \Phi^I(x)} G_{IJ}^+(x, x') \frac{\delta A}{\delta \Phi^J(x')} = \int dx dx' \frac{\delta B}{\delta \phi^j(x')} G_{JI}^-(x', x) \frac{\delta A}{\delta \phi^j(x)} = D_B^- A, \quad (2.86)$$

where we have used the identity  $G_{IJ}^+(x, x') = G_{JI}^-(x', x)$ . Thus, the Peierls bracket may also be written in the manifestly antisymmetric form

$$\{A, B\} = D_B^- A - D_A^- B = D_A^+ B - D_B^+ A. \quad (2.87)$$

The expressions (2.86) in terms of  $G_{IJ}^\pm(x, x')$  are also useful in order to verify that the Peierls bracket defines a Lie-Poisson algebra. In particular, the derivation property  $\{A, BC\} = \{A, B\}C + \{A, C\}B$  follows immediately from the Leibnitz rule for functional derivatives. The Jacobi identity also follows by a straightforward calculation, making use of the fact that functional derivatives of the action commute (see e.g., [72, 73]). If one desires, one may use related Green's function techniques to extend the Peierls bracket to a Lie algebra of gauge dependent quantities [74].

### 2.4.2 Main Argument

We wish to show that the charges  $Q[\xi]$  generate the appropriate asymptotic symmetry for any asymptotic Killing field  $\xi$ . Since this is true by definition for any Hamiltonian charge  $H[\xi]$ , it will then follow that  $Q[\xi] - H[\xi]$  is constant over the space of solutions  $\mathcal{S}$ . We first address the case where  $\xi$  is compatible with  $\Omega$ , and then proceed to the more general case where  $\hat{\xi}$  acts only as a conformal Killing field on the boundary.

Showing that  $Q[\xi]$  generates diffeomorphisms along  $\xi$  amounts to proving a certain version of Noether's theorem. Recall that the proof of Noether's theorem involves examining the change in the action under a spacetime-dependent generalization of the desired symmetry. The structure of our argument below is similar, where we consider both the action of a given asymptotic symmetry  $\xi$  and the spacetime-dependent generalization  $f\xi$  defined by choosing an appropriate scalar function  $f$  on  $M$ . It turns out to be useful to choose  $f$  on  $M$  (with restriction  $\hat{f}$  to  $\partial M$ ) such that

- $f = 0$  in the far past and  $f = 1$  in the far future.
- $\hat{f} = 0$  to the past of some Cauchy surface  $C_0$  of  $\partial M$ , and  $\hat{f} = 1$  to the future of some Cauchy surface  $C_1$  of  $\partial M$ .

Suppose now that  $\xi$  is an asymptotic symmetry compatible with  $\Omega$ . Then the bulk and boundary fields transform as

$$\delta\phi = \mathcal{L}_\xi\phi, \quad \delta g_{\mu\nu} = \mathcal{L}_\xi g_{\mu\nu}, \quad \delta\gamma_{ij}^{(0)} = \mathcal{L}_{\hat{\xi}}\gamma_{ij}^{(0)} = 0, \quad \text{and} \quad \delta\phi^{(0)} = \mathcal{L}_{\hat{\xi}}\phi^{(0)} = 0. \quad (2.88)$$

The key step of the argument is to construct a new transformation  $\Delta_{f,\xi}$  on the space of fields such that the associated first order change  $\Delta_{f,\xi}S$  in the action generates the asymptotic symmetry  $-\xi$ . We will first show that the above property turns out to hold for

$$\Delta_{f,\xi} := (\mathcal{L}_{f\xi} - f\mathcal{L}_\xi), \quad (2.89)$$

and then verify that  $\Delta_{f,\xi}S = -Q[\xi]$ . The form of  $\Delta_{f,\xi}S$  is essentially that suggested in [75] using Hamilton-Jacobi methods, so our argument will also connect  $Q[\xi]$  with [75].

An important property of (2.89) is that the changes  $\Delta_{f,\xi}g_{\mu\nu}$  and  $\Delta_{f,\xi}\phi$  are *algebraic* in  $\phi$  and  $g_{\mu\nu}$ ; i.e., we need not take spacetime derivatives of  $g_{\mu\nu}, \phi$  to compute the action of  $\Delta_{f,\xi}$ . Furthermore,  $\Delta_{f,\xi}\phi$  and  $\Delta_{f,\xi}g_{\mu\nu}$  are both proportional to  $\nabla_a f$ , and so vanish in both the far future and the far past. This guarantees that  $\Delta_{f,\xi}S$  is a differentiable function on  $\mathcal{H}$ . In particular, solutions to the equations of motion resulting from the deformed action  $S + \epsilon\Delta_{f,\xi}S$  are indeed stationary points of  $S + \epsilon\Delta_{f,\xi}S$  under all variations which preserve the conditions and vanish

in the far future and past.

It is important to note that the quantity  $\Delta_{f,\xi}S$  is gauge-invariant when the equations of motion hold. This is easy to see since by definition on  $\mathcal{S}$  all variations of  $S$  become pure boundary terms. Boundary terms in the far past and future vanish due to the observations above, and since  $\gamma_{ij}^{(0)}, \phi^{(0)}$  are fixed by boundary conditions the boundary terms on  $\partial M$  depend on the bulk fields only through the gauge invariant quantities  $T_{\text{bdy}}^{ij}$  and  $\Phi_{\text{bdy}}$ . Thus, we may take the Peierls bracket of  $\Delta_{f,\xi}S$  with any other observable  $A$ .

We proceed by considering the modified action

$$\tilde{S}[\phi, g_{\mu\nu}] = S[\phi, g_{\mu\nu}] + \epsilon \Delta_{f,\xi}S[\phi, g_{\mu\nu}] = S[\phi + \epsilon \Delta_{f,\xi}\phi, g_{\mu\nu} + \epsilon \Delta_{f,\xi}g_{\mu\nu}], \quad (2.90)$$

where the last equality holds to first order in  $\epsilon$  (and in fact defines  $\Delta_{f,\xi}S[\phi, g_{\mu\nu}]$ ). Since  $\tilde{S}$  is just  $S$  with its argument shifted by  $\epsilon \Delta_{f,\xi}$ , the stationary points  $s_1$  of  $\tilde{S}$  are precisely the oppositely-shifted versions of the stationary points  $s$  of  $S$ ; i.e., we may write  $s_1 = (1 - \epsilon \Delta_{f,\xi})s$  for some  $s \in \mathcal{S}$ .

We should of course ask if  $s_1$  satisfies the desired boundary conditions on  $\partial M$ . Since  $\xi$  is compatible with  $\Omega$ , the boundary fields shift in the same way as their bulk counterparts; i.e., those of  $s_1$  have been shifted by  $-\epsilon \Delta_{f,\xi}$  relative to those of  $s$ . Since  $\xi$  is an asymptotic symmetry, its action preserves the boundary fields. Now, the reader will note that there is a non-trivial effect from the  $\mathcal{L}_{f\xi}$  term in  $\Delta_{f,\xi}$ . But this term is a pure diffeomorphism, and since all boundary terms are covariant on  $\partial M$  the action  $\tilde{S}$  is invariant under *all* diffeomorphisms compatible with  $\Omega$  (i.e., which preserve the given conformal frame), even those

that act non-trivially on the boundary. So the history

$$s_2 = (1 + \epsilon \mathcal{L}_{f\xi})s_1 = (1 + \epsilon f \mathcal{L}_\xi)s \quad (2.91)$$

has

$$\phi^{(0)}|_{s_2} = \phi^{(0)}|_s, \quad g_{\mu\nu}|_{s_2} = g_{\mu\nu}|_s, \quad (2.92)$$

and again solves the equations of motion that follow from  $\tilde{S}$ .

This observation allows a straightforward computation of the advanced and retarded changes  $D_{\Delta_{f,\xi}S}^\pm A$  for any gauge invariant quantity  $A$ . We first consider the retarded change evaluated on a solution  $s$  as above. We require a solution  $s_\epsilon^-$  of the perturbed equations of motion which agrees with  $s$  in the far past. Since the infinitesimal transformation  $f \mathcal{L}_\xi$  vanishes in the far past, we may set  $s_\epsilon^- = s_2$  as defined (2.91) above; i.e.  $s_\epsilon^- = (1 + \epsilon f \mathcal{L}_\xi)s$ . Thus, the retarded effect on  $A$  is just  $D_{\Delta_{f,\xi}S}^- A = f \mathcal{L}_\xi A$ .

To compute the advanced effect, we must find a solution  $s_\epsilon^+$  of the perturbed equations of motion which agrees with  $s$  in the far future. Consider the history  $s_\epsilon^+ = (1 - \epsilon \mathcal{L}_\xi)s_\epsilon^- = (1 + (f - 1)\epsilon \mathcal{L}_\xi)s$ . Since this differs from  $s_\epsilon^-$  by the action of a symmetry compatible with  $\Omega$ , it again solves the desired equations of motion (to first order in  $\epsilon$ ) and induces the required boundary fields (2.92). In addition,  $s_\epsilon^+$  and  $s$  agree in the far future (where  $f = 1$ ). Thus, we may use  $s_\epsilon^+$  to compute the advanced change in any gauge invariant  $A$ :

$$D_{\Delta_{f,\xi}S}^+ A = (f - 1) \mathcal{L}_\xi A. \quad (2.93)$$

Finally, we arrive at the Peierls bracket

$$\{\Delta_{f,\xi}S, A\} = D_{\Delta_{f,\xi}S}^+ A - D_{\Delta_{f,\xi}S}^- A = -\mathcal{L}_\xi A. \quad (2.94)$$

As desired  $-\Delta_{f,\xi}S$  generates a diffeomorphism along the asymptotic symmetry  $\xi$  as desired.

All that remains is to relate  $\Delta_{f,\xi}S$  to  $Q[\xi]$ . But this is straightforward. Since  $f$  vanishes in the far past and future we have

$$\Delta_{f,\xi}S = \int_M \left( \frac{\delta S}{\delta \phi} \Delta_{f,\xi} \phi + \frac{\delta S}{\delta g_{\mu\nu}} \Delta_{f,\xi} g_{\mu\nu} \right) + \frac{1}{2} \int_{\partial M} \sqrt{\gamma^{(0)}} T_{\text{bndy}}^{ij} \Delta_{f,\xi} \gamma_{ij}^{(0)} + \int_{\partial M} \sqrt{\gamma^{(0)}} \Phi_{\text{bndy}} \Delta_{f,\xi} \phi^{(0)}. \quad (2.95)$$

But the bulk term vanishes on solutions  $s \in \mathcal{S}$ , and from (2.88) we find  $\Delta_{f,\xi} \phi^{(0)} = (\mathcal{L}_{\hat{f}\hat{\xi}} - \hat{f}\mathcal{L}_{\hat{\xi}})\phi^{(0)} = 0$ . So only the term containing  $T_{\text{bndy}}^{ij}$  contributes to (2.95).

To compute the remaining term note that

$$\Delta_{f,\xi} \gamma_{ij}^{(0)} = (\mathcal{L}_{\hat{f}\hat{\xi}} - \hat{f}\mathcal{L}_{\hat{\xi}})\gamma_{ij}^{(0)} = \hat{\xi}_i \partial_j \hat{f} + \hat{\xi}_j \partial_i \hat{f}. \quad (2.96)$$

Since (2.96) vanishes when  $f$  is constant, we may restrict the integral over  $\partial M$  to the region  $V$  between  $C_0$  and  $C_1$  and use the symmetry  $T_{\text{bndy}}^{ij} = T_{\text{bndy}}^{ji}$  to obtain

$$\begin{aligned} \Delta_{f,\xi}S &= \int_V \sqrt{|\gamma^{(0)}|} T_{\text{bndy}}^{ij} \xi_i \partial_j f \\ &= \int_{C_1} \sqrt{q} n_j T_{\text{bndy}}^{ij} \xi_i - \int_V \sqrt{|\gamma^{(0)}|} f D_i (T_{\text{bndy}}^{ij} \xi_j) \\ &= -Q_{C_1}[\xi]. \end{aligned} \quad (2.97)$$

Here we used the fact that  $\hat{f} = 0$  on  $C_0$  to drop contributions from  $C_0$  and the



fact that that  $\hat{\xi}$  is a Killing field of the boundary metric along with (2.79) to show that the  $\int_V$  term in the second line vanishes.

Thus,  $-\Delta_{f,\xi}S$  agrees (on solutions) with the charge  $Q[\xi]$  evaluated on the cut  $C_1$ . Since  $Q[\xi]$  is conserved, this equality also holds on any other cut of  $\partial M$ . Having already shown by eq. (2.94) that the variation  $\Delta_{f,\xi}S$  generates the action of the infinitesimal symmetry  $-\xi$  on observables, it follows that  $Q[\xi]$  generates the action of  $\xi$ :

$$\{Q[\xi], A\} = \mathcal{L}_\xi A, \quad (2.98)$$

as desired.

### 2.4.3 Asymptotic Symmetries not compatible with $\Omega$

We now generalize the argument to asymptotic symmetries  $\xi$  that are *not* compatible with  $\Omega$ , so that  $\hat{\xi}$  satisfies (2.78). The field content and boundary conditions are the same as above. But the non-trivial action of  $\xi$  on  $\Omega$  means that there are now additional terms when a diffeomorphism acts on the boundary fields  $\phi^{(0)}, \gamma_{ij}^{(0)}$ :

$$\delta_{\mathcal{L}_{f\xi}}\phi^{(0)} = \mathcal{L}_{\hat{f}\xi}\phi^{(0)} - \Delta_{-}\hat{f}\sigma\phi^{(0)}, \quad \delta_{\mathcal{L}_{f\xi}}\gamma_{ij}^{(0)} = \mathcal{L}_{\hat{f}\xi}\gamma_{ij}^{(0)} + 2\hat{f}\sigma\gamma_{ij}^{(0)}. \quad (2.99)$$

Combining (2.78) and (2.99) we see that  $\delta_{\mathcal{L}_\xi}$  acts trivially on the boundary data  $\gamma_{ij}^{(0)}, \phi^{(0)}$ , as it must since asymptotic symmetries were defined to leave the boundary conditions invariant. Thus the histories  $s_\epsilon^\pm$  identified above (see, e.g., (2.91)) again satisfy the same boundary conditions as  $s$ .

In contrast to section 2.4.2 the operation  $\mathcal{L}_{f\xi}$  now acts non-trivially on  $\Omega$  and thus on  $S$ . But since this is only through the conformal anomaly term  $a_{(d)}$  in (2.65),  $\mathcal{L}_{f\xi}S$  depends only on the boundary metric  $\gamma^{(0)}$  and is otherwise constant on  $\mathcal{H}$ . So the equations of motion are unchanged and the histories  $s_\epsilon^\pm$  again solve the equations of motion for  $\tilde{S}$ .

It remains to repeat the analogue of the calculation (2.97). But here the only change is that the  $\int_V$  term on the second line no longer vanishes. Instead, it contributes a term proportional to  $a_{(d)}$ . Since this term is constant on the space of solutions  $\mathcal{S}$ , it has vanishing Peierls brackets and we again conclude that  $Q_{C_1}[\xi]$  generates the asymptotic symmetry  $\xi$ . (This comment corrects a minor error in [74].) And since  $Q_C[\xi]$  depends on the Cauchy surface  $C$  only through a term that is constant on  $\mathcal{S}$ , the same result holds for any  $C$ . Thus, even when  $\hat{\xi}$  is only a conformal symmetry of the boundary,  $Q_C[\xi] - H[\xi]$  is constant over the space  $\mathcal{S}$  of solutions.

#### 2.4.4 Charge algebras and central charges

We saw above that our charges  $Q[\xi]$  generate the desired asymptotic symmetries via the Peierls bracket. This immediately implies what is often called the *representation theorem*, that the algebra of the charges themselves matches that of the associated symmetries up to possible so-called central extensions. This point is really quite simple. Consider three vector field  $\xi_1, \xi_2, \xi_3$  related via the Lie bracket through  $\{\xi_1, \xi_2\} = \xi_3$ . Now examine the Jacobi identity

$$\{Q[\xi_1], \{Q[\xi_2], A\}\} + \{Q[\xi_2], \{A, Q[\xi_1]\}\} + \{A, \{Q[\xi_1], Q[\xi_2]\}\} = 0 \quad (2.100)$$

which must hold for any  $A$ . Since  $\{Q[\xi_i], B\} = \mathcal{L}_{\xi_i} B$  for any  $B$ , we may use (2.100) to write

$$\mathcal{L}_{\xi_3} A = \mathcal{L}_{\xi_1} (\mathcal{L}_{\xi_2} A) - \mathcal{L}_{\xi_2} (\mathcal{L}_{\xi_1} A) = \{\{Q[\xi_2], Q[\xi_1]\}, A\}. \quad (2.101)$$

But the left-hand-side is also  $\{Q[\xi_3], A\}$ . So we conclude that  $\{Q[\xi_1], Q[\xi_2]\}$  generates the same transformation as  $Q[\xi_3]$ . This means that they can differ only by some  $K(\xi_1, \xi_2)$  which is constant across the space of solutions (i.e., it is a so-called c-number):

$$\{Q[\xi_1], Q[\xi_2]\} = Q[\{\xi_1, \xi_2\}] + K(\xi_1, \xi_2). \quad (2.102)$$

For some symmetry algebras one can show that any such  $K(\xi_i, \xi_j)$  can be removed by shifting the zero-points of the charges  $Q[\xi]$ . In such cases the  $K(\xi_i, \xi_j)$  are said to be trivial. Non-trivial  $K(\xi_i, \xi_j)$  are classified by a cohomology problem and are said to represent central extensions of the symmetry algebra.

It is easy to show that  $K(\xi_i, \xi_j)$  may be set to zero in this way whenever there is some solution (call it  $s_0$ ) which is invariant under all symmetries. The fact that it is invariant means that  $\{Q[\xi_i], A\}(s_0) = 0$ ; i.e., the bracket vanishes when evaluated on the particular solution  $s_0$  for any  $\xi_i$  and any  $A$ . So take  $A = Q[\xi_j]$ , and set the zero-points of the charges so that  $Q[\xi](s_0) = 0$ . Evaluating (2.102) on  $s_0$  then gives  $K(\xi_i, \xi_j)(s_0) = 0$  for all  $\xi$ . But since  $K(\xi_i, \xi_j)(s_0)$  is constant over

the space of solutions this means that it vanishes identically.

For asymptotically flat spacetimes the asymptotic symmetries generate the Poincaré group, which are just the exact symmetries of Minkowski space. Thus one might expect the asymptotic symmetries of  $(d+1)$ -dimensional AlAdS spacetimes to be (perhaps a subgroup of)  $SO(d, 2)$  in agreement with the isometries of  $\text{AdS}_{d+1}$  compatible with the boundary conditions on  $\partial M$ . Since (at least when it is allowed by the boundary conditions) empty  $\text{AdS}_{d+1}$  is a solution invariant under all symmetries one might expect that the corresponding central extensions are trivial.

This turns out to be true for  $d > 2$ . Indeed, any Killing field of  $\text{AdS}_{d+1}$  automatically satisfies our definition of an asymptotic symmetry (at least for boundary conditions  $\phi^{(0)} = 0$  and  $\gamma_{ij}^{(0)}$  the metric on the Einstein static universe). But for  $d = 2$  there are additional asymptotic Killing fields that are not Killing fields of empty  $\text{AdS}_3$ . This is because all  $d = 2$  boundary metrics  $\gamma_{ij}^{(0)}$  take the form  $ds^2 = g_{uv}dudv$  when written in terms of null coordinates, making manifest that any vector field  $\hat{\xi}^u = f(u)$ ,  $\hat{\xi}^v = g(v)$  is a conformal Killing field of  $\gamma_{ij}^{(0)}$ . This leads to an infinite-dimensional asymptotic symmetry group, which is clearly much larger than the group  $SO(2, 2)$  of isometries of  $\text{AdS}_3$ .

Thus as first noted in [35] there can be a non-trivial central extension for  $d = 2$ . In this case, one can show that up to the above-mentioned zero-point shifts all central extensions are parametrized by a single number  $c$  called the central charge. (When parity symmetry is broken, there can be separate left and right central charges  $c_L, c_R$ .) Ref [35] calculated this central charge using Hamiltonian methods, but we will follow [53] and work directly with

the boundary stress tensor.

Since the charges  $Q[\xi]$  generate (bulk) diffeomorphisms along  $\xi$ , and since the charges themselves are built from  $T_{\text{bdy}}^{ij}$ , the entire effect is captured by computing the action of a bulk diffeomorphism  $\xi$  on  $T_{\text{bdy}}^{ij}$ . As noted in section 2.2.5, the action of  $\xi$  on boundary quantities generally involves both a diffeomorphism  $\hat{\xi}$  along the boundary and a change of conformal frame. And as we have seen, for even  $d$  changes of conformal frame act non-trivially on  $T_{\text{bdy}}^{ij}$ . For  $g_{uv} = -1$  a direct calculation gives

$$\begin{aligned} T_{\text{bdy } uu} &\rightarrow T_{\text{bdy } uu} + (2T_{\text{bdy } uu}\partial_u\xi^u + \xi^u\partial_u T_{\text{bdy } uu}) - \frac{c}{24\pi}\partial_u^3\xi^u \\ T_{\text{bdy } vv} &\rightarrow T_{\text{bdy } vv} + (2T_{\text{bdy } vv}\partial_v\xi^v + \xi^v\partial_v T_{\text{bdy } vv}) - \frac{c}{24\pi}\partial_v^3\xi^v, \end{aligned} \quad (2.103)$$

where  $c = 3\ell/2G$ . The term in parenthesis is the tensorial part of the transformation while the final (so called anomalous) term is associated with the conformal anomaly  $a_{(2)} = -(c/24\pi)\mathcal{R}$ .

It is traditional to Fourier transform the above components of the stress tensor to write the charge algebra as the (double) Virasoro algebra

$$i\{L_m, L_n\} = (m-n)L_{m+n} + \frac{c}{12}m(m^2-1)\delta_{m+n,0}, \quad (2.104)$$

$$i\{\bar{L}_m, \bar{L}_n\} = (m-n)\bar{L}_{m+n} + \frac{c}{12}m(m^2-1)\delta_{m+n,0}, \quad (2.105)$$

where  $\{L_n, \bar{L}_m\} = 0$  and

$$L_n = -\frac{1}{2\pi} \int_{S^1} e^{iun} T_{\text{bdy } uu} du, \quad \bar{L}_n = -\frac{1}{2\pi} \int_{S^1} e^{ivn} T_{\text{bdy } vv} dv. \quad (2.106)$$

Here we have take  $\partial M = S^1 \times \mathbb{R}$  so that the dynamics requires both  $T_{uu}$  and  $T_{vv}$  to be periodic functions of their arguments. We have taken this period to be  $2\pi$ .

The anomalous transformation of  $T_{\text{bdy}}^{ij}$  leads to interesting zero-points for certain charges. Suppose for example we take  $T_{\text{bdy}}^{ij}$  to vanish for the Poincaré patch of empty  $\text{AdS}_3$  in the conformal frame where the boundary metric is (uncompactified) Minkowski space. Then since  $S^1 \times \mathbb{R}$  is (locally) conformal to Minkowski space, we can use the conformal anomaly to calculate  $T_{\text{bdy}}^{ij}$  for empty  $\text{AdS}_3$  with Einstein static universe boundary metric. One finds that the resulting energy does not vanish. Instead,  $E_{\text{global AdS}_3} = -c/12\ell = -1/8G$  so that  $E = 0$  for the so-called  $M = 0$  Bañados-Teitelboim-Zanelli (BTZ) black hole [76, 77]. The offset in (2.83) arises from similarly setting  $T_{\text{bdy}}^{ij} = 0$  for empty  $\text{AdS}_5$  in the conformal frame where the boundary metric is (uncompactified) Minkowski space.

## 2.5 The algebra of boundary observables and the AdS/CFT correspondence

We have shown above how the boundary stress tensor can be used to construct charges  $Q[\xi]$  associated with any asymptotic symmetry  $\xi$  of a theory of asymptotically locally anti-de Sitter spacetimes. The  $Q[\xi]$  are conserved (perhaps, up to c-number anomaly terms) and generate the asymptotic symmetry  $\xi$  under the action of the Peierls bracket (or equivalently, under the Poisson bracket). Therefore the  $Q[\xi]$  are equivalent to the Hamiltonian charges that we could derive using techniques analogous to those familiar from studying asymptotically flat spacetimes. Conversely, boundary stress tensor methods can also be applied in the asymptoti-

cally flat context [78, 79, 80]. Readers interested in direct Hamiltonian approaches to AdS charges should consult [33, 34, 35]; see also [32, 81, 82, 40, 41, 83, 84] for other covariant approaches.

We chose to use boundary stress tensor methods for two closely related reasons. The first is that, in addition to its role in constructing conserved charges, the local boundary field  $T_{\text{bdy}}^{ij}$  turns out to contain useful information on its own. For example, it plays a key role in the hydrodynamic description of large AdS black holes known as the fluid/gravity correspondence [85] (which may be considered a modern incarnation of the so-called membrane paradigm [86]). The extra information in  $T_{\text{bdy}}^{ij}$  appears at the AdS boundary  $\partial M$  due to the fact that all multipole moments of a given field decay near  $\partial M$  with the same power law; namely, the one given by the  $\gamma^{(d)}$  term in the Fefferman-Graham expansion (2.21). This is in striking contrast with the more familiar situation in asymptotically flat spacetimes where the large  $r$  behavior is dominated by the monopole terms, with sub-leading corrections from the dipole and higher order multipoles. Indeed, while as noted above similar boundary stress tensor techniques can be employed in asymptotically flat spacetimes, the asymptotically flat boundary stress tensor contains far less information.

The second reason is that both  $T_{\text{bdy}}^{ij}$  and  $\Phi_{\text{bdy}}$  play fundamental roles in the AdS/CFT correspondence [1] (see especially [3]). Any treatment of asymptotic AdS charges would be remiss without at least mentioning this connection, and we take the opportunity below to give a brief introduction to AdS/CFT from the gravity side. This turns out to be straightforward using the machinery described thus far. Indeed, the general framework requires no further input from either

string theory or conformal field theory and should be readily accessible to all readers of this volume. As usual, we consider bulk gravity coupled to a single bulk scalar and fix both  $\gamma_{ij}^{(0)}$  and  $\phi^{(0)}$  as boundary conditions. We refer to  $\gamma_{ij}^{(0)}$  and  $\phi^{(0)}$  as boundary sources below. More general boundary conditions may be thought of as being dual to CFTs with additional interactions [87] or coupled to additional dynamical fields [88, 89, 54], though we will not go into the details here.

The only new concept we require is that of the algebra  $\mathcal{A}_{\text{bdy}}$  of boundary observables, which is just the algebra generated by  $T_{\text{bdy}}^{ij}$  and  $\Phi_{\text{bdy}}$  under the Peierls bracket. Here we mean that we consider the smallest algebra containing both  $T_{\text{bdy}}^{ij}$  and  $\Phi_{\text{bdy}}$  which is closed under finite flows; i.e., under the classical analogue of the quantum operation  $e^{iA} B e^{-iA}$ . A key property of  $\mathcal{A}_{\text{bdy}}$  follows from the fact that the bulk equations of motion are completely independent of the choice of conformal frame  $\Omega$ . Thus, up to the usual conformal anomalies, under any change of conformal frame the boundary observables transform only by rescaling with a particular power of  $e^{-\sigma}$  known as the conformal dimension-conformal transformation ( $d$  for  $T_{\text{bdy}}^{ij}$ , and  $\Delta_+$  for  $\Phi_{\text{bdy}}$ ), with the boundary sources transforming similarly with conformal weights zero for  $\gamma_{ij}^{(0)}$  and  $\Delta_-$  for  $\phi^{(0)}$ . (In defining the conformal dimension it is conventional not to count the  $\pm 2$  powers of  $e^{-\sigma}$  associated with the indices on  $T_{\text{bdy}}^{ij}$  and  $\gamma_{ij}^{(0)}$ .) In this sense the theory of  $\mathcal{A}_{\text{bdy}}$  is invariant (or, perhaps better, covariant) under all changes of boundary conformal frame. Of course we have already shown that when the boundary observables admit a conformal Killing field  $\hat{\xi}$ , the corresponding transformation is generated by the associated  $Q[\xi]$  from (2.80). Now since the charges  $Q[\xi]$  are built from  $T_{\text{bdy}}^{ij}$  and  $\Phi_{\text{bdy}}$  they also lie in the algebra  $\mathcal{A}_{\text{bdy}}$ . When  $\hat{\xi}$  can be chosen to



be everywhere timelike, this immediately implies that  $\mathcal{A}_{\text{bdy}}$  is also closed under time evolution. This last property can also be shown much more generally; see e.g. [90].

We now extract one final property of the algebra  $\mathcal{A}_{\text{bdy}}$ . From the expression (2.86) in terms of Green's functions, it is clear that the Peierls bracket  $\{A, B\}$  of two observables vanishes on any solution  $s$  for which  $A, B$  are outside each other's light cones; i.e., when the regions on which  $A, B$  are supported cannot be connected by any causal curve. Furthermore, as shown in [91] the null energy condition implies that two boundary points  $x, y$  can be connected by a causal curve through the bulk only when they can also be connected by a causal curve lying entirely in the boundary. It follows that the algebra  $\mathcal{A}_{\text{bdy}}$  satisfies the usual definition of locality for a field theory on  $\partial M$ ; namely that Peierls brackets vanish outside the light cones defined by the boundary metric  $\gamma_{ij}^{(0)}$ .

Though we have so far worked entirely at the classical level, let us now assume that all of the above properties persist in the quantum theory. We then have a conformally covariant algebra of operators  $\mathcal{A}_{\text{bdy}}$  with closed dynamics, local commutation relations on  $\partial M$ , and a stress tensor  $T_{\text{bdy}}^{ij}$  that generates all conformal symmetries. In other words, we have a local conformal field theory on  $\partial M$ .

This is the most basic statement of the AdS/CFT correspondence. *Any* bulk AlAdS quantum gravity theory in which the above classical properties continue to hold defines a conformal field theory (CFT) through its algebra  $\mathcal{A}_{\text{bdy}}$  of boundary observables. Now, we should remark that the AdS/CFT correspondence as used in string theory goes one step further. For certain specific bulk theories it identifies the so-called dual CFT as a particular known theory defined by its own Lagrangian

with a definite field content. For example, when the bulk is type IIB string theory asymptotic to a certain  $\text{AdS}_5 \times S^5$  solution, the corresponding CFT is just  $\mathcal{N} = 4$  super-Yang-Mills. We will not go into further details here, though the interested reader may consult various reviews such as [4, 5, 7].

On the other hand, even without having a separate definition of the CFT, the above observations already have dramatic implications for the bulk quantum gravity theory. In particular, the statement that  $\mathcal{A}_{\text{bdy}}$  is closed under time evolution runs completely counter to one's usual intuition regarding field theory with a boundary. We usually think that most of the dynamical degrees of freedom live in the bulk spacetime, with perhaps only a small subset visible on the boundary at any time. In particular, we expect any signal present on the boundary at time  $t_0$  to then propagate into the bulk and (at least for some time) to essentially disappear from the algebra of boundary observables. Since  $\mathcal{A}_{\text{bdy}}$  is closed under time evolution, it is clear that this is simply not the case in our quantum gravity theory. The difference arises precisely from the fact that the gravitational Hamiltonian (and more generally any  $Q[\xi]$ ) is a pure boundary term. This property was called *boundary unitarity* in [90]. See also [92] for further discussion of this point.

The reader should take care to separate boundary unitarity from the possible claim that  $\mathcal{A}_{\text{bdy}}$  captures the complete set of bulk observables. The two ideas are logically separate, as there can in principle be additional bulk observables  $\mathcal{A}_{\text{other}}$  so long as they do not mix dynamically with those in  $\mathcal{A}_{\text{bdy}}$ . One says that the possible values of  $\mathcal{A}_{\text{other}}$  define superselection sectors with respect to  $\mathcal{A}_{\text{bdy}}$  [93]. But any such additional observables are clearly very special. The requirement that they not affect  $\mathcal{A}_{\text{bdy}}$  strongly suggests that at least semi-classically such

observables have to do only with properties of spacetime hidden from the boundary behind both past and future horizons [94]. In particular, any degrees of freedom that determine whether black holes are connected by (non-traversable) wormholes seem likely to lie in  $\mathcal{A}_{\text{other}}$ . On the other hand, in perturbation theory about empty AdS (or even about solutions that are empty AdS in the far past) one may show that  $\mathcal{A}_{\text{other}}$  is indeed empty [90].

# Chapter 3

## Generalized gravitational entropy without replica symmetry

### 3.1 Introduction

A major goal of quantum gravity is to understand the microscopic origin of Bekenstein's formula [95, 96, 97]

$$S = \frac{\text{Area}}{4G}. \tag{3.1}$$

One approach to studying this problem is to derive (3.1) from a path integral formulation of quantum gravity. In the seminal paper [98], Gibbons and Hawking derived (3.1) for states described by a Euclidean path integral that is dominated by a  $U(1)$  symmetric saddle point.

AdS/CFT has provided a comprehensive framework for understanding gravitational path integrals by identifying certain string theories with particular con-

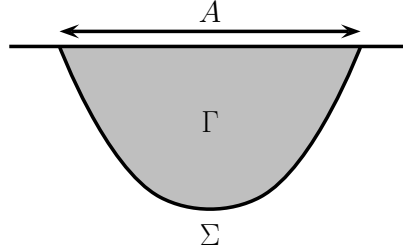

Figure 3.1: A sketch of the Ryu–Takayanagi surface  $\Sigma$  associated with some boundary region  $A$ .  $\Gamma$  is a codimension-one surface satisfying  $\partial\Gamma = \Sigma \cup A$ .

formal field theories [1, 3, 2]. By using this correspondence (3.1) can be derived from the path integral of the dual field theory. Ryu and Takayanagi [19, 20] have proposed that this result is a special case of a more general correspondence between area and entropy. They conjecture that in holographic theories the von Neumann entropy of the density matrix  $\rho$  associated with a CFT region  $A$  is given by the area of a surface in the bulk geometry, i.e.

$$S(\rho) = \frac{\text{Area}[\Sigma]}{4G}. \quad (3.2)$$

In Euclidean AdS/CFT, the surface  $\Sigma$  is defined as the minimum area codimension-two surface for which there exists a codimension-one surface  $\Gamma$  satisfying  $\partial\Gamma = \Sigma \cup A$  (see Fig. 3.1). This latter restriction is commonly known as the homology constraint [99].

Significant progress has been made towards deriving (3.2) by Lewkowycz and Maldacena [21].<sup>1</sup> Their derivation, which we review in section 3.2 below, applies whenever  $\text{Tr}\rho^n$  is equal to a Euclidean path integral dominated by saddles which preserve replica symmetry. Replica symmetry refers to a discrete global  $\mathbb{Z}_n$

<sup>1</sup>see also [100, 101].

symmetry when the field theory path integral is computed over  $n$  copies of the original manifold. This replica construction can be used to compute the integer Rényi entropies

$$S_n(\rho) = -\frac{1}{n-1} \log \left( \frac{\text{Tr}[\rho^n]}{\text{Tr}[\rho]^n} \right). \quad (3.3)$$

In AdS/CFT,  $\rho^n$  is dual to a gravitational solution on a bulk manifold  $M^n$  with metric  $g^{(n)}$ . By analytically continuing  $g^{(n)}$  to real  $n$  and taking the limit  $n \rightarrow 1$  Lewkowycz and Maldacena calculated the von Neumann entropy and found that it is equal to the area of an extremal area surface, consistent with the formula (3.2).

This derivation was subsequently extended to higher curvature theories of gravity. Not surprisingly, several technical subtleties arise when higher curvature terms are included in the action. Still, the Lewkowycz–Maldacena method gives a prescription for calculating the entropy functional [102, 103, 104, 105]. However, several researchers [106, 107, 108, 109] have noticed obstructions to deriving the equations of motion for  $\Sigma$  when using the Lewkowycz–Maldacena ansatz for  $g^{(n)}$ .

This problem can be understood as follows. In general relativity, Lewkowycz and Maldacena derive the extremal area condition by requiring that  $g^{(n)}$  satisfy the Einstein equation to leading order in  $(n-1)$ . Assuming that the matter stress tensor remains finite, this entails discarding potentially divergent contributions to the Ricci tensor. To first order in  $(n-1)$ , only the transverse-transverse components of the Ricci diverge, and these divergences can be cured by requiring that the trace of the extrinsic curvature vanish in both transverse directions. Thus there is a precise matching between the structure of potential divergences in the field

equations and the constraints necessary to fix the location of the surface  $\Sigma$ . However, in higher curvature theories all components of the field equations generally diverge, and these divergences outnumber the degrees of freedom of  $\Sigma$ . Furthermore, even if one focuses only on the transverse-transverse divergences, these split into “leading” and “subleading”, the latter suppressed by powers of  $r^{n-1}$  relative to the former, where  $r$  is a radial coordinate centered on the entangling surface  $\Sigma$ . It was noted in [108, 103] that, for a large family of higher curvature theories of gravity, requiring the leading transverse-transverse divergences to vanish extremizes the entropy on  $\Sigma$ . This observation raises the question of what to do with the subleading divergences, and with the divergences in the other components.

One purpose of this paper is to resolve this problem by generalizing the Lewkowycz and Maldacena ansatz for  $g^{(n)}$ . By including terms which are pure gauge for  $n = 1$  but physical for  $n \neq 1$  we obtain a richer structure of divergences in the curvature which propagates to all components of the Ricci tensor. We will also allow  $g^{(n)}$  to break replica symmetry. We present these generalizations in section 3.3 and show that we are able to rederive the results of [21]. This means showing that, despite the additional constraints from the field equations, we do not over constrain the location of  $\Sigma$ . The analysis also suggests that the assumption of replica symmetry can be dropped from the derivation of [21], as we discuss below.

In section 3.4 we apply our technique to general relativity plus a small Gauss–

Bonnet coupling. The action for this theory is [110, 111]

$$I_{GB} = -\frac{1}{16\pi G} \int d^D y \sqrt{g} (R + \lambda(R_{\mu\nu\rho\sigma}R^{\mu\nu\rho\sigma} - 4R_{\mu\nu}R^{\mu\nu} + R^2)) + I_{\text{matter}} + \dots, \quad (3.4)$$

where the dots indicate boundary terms and  $O(\lambda^2)$  terms. More properly, the latter are controlled by the small dimensionless parameter  $(\lambda \text{Riem})^2$ . We can regard this setup as a toy model for the  $\alpha'$  expansions that arise in string theory [112].<sup>2</sup> In  $D \leq 4$  the term proportional to  $\lambda$  is a total derivative and does not contribute to the equations of motion, so we will work in  $D > 4$ . It was argued in [117, 118] that the analog of the Ryu–Takayanagi formula (3.2) for Einstein–Gauss–Bonnet should be the Jacobson–Myers entropy [119, 120]

$$S_{JM} = \frac{1}{4G} \left( \text{Area} + 2\lambda \int_{\Sigma} d^{D-2}\sigma \sqrt{\gamma} \mathcal{R} \right) + \dots, \quad (3.5)$$

evaluated on a surface  $\Sigma$  that extremizes (3.5), or equivalently, on a surface which satisfies

$$(\gamma^{ij} - 4\lambda \mathcal{R}^{ij}) \mathcal{K}_{ijz} + O(\lambda^2) = 0. \quad (3.6)$$

Here  $\gamma_{ij}$  is the metric induced on  $\Sigma$ , and  $\mathcal{R}_{ijkl}$  and  $\mathcal{K}_{ijz}$  are its intrinsic and extrinsic curvatures.

The first half of this conjecture, namely that the appropriate entropy functional is the Jacobson–Myers entropy, was shown in [102, 103, 104]. However, the

---

<sup>2</sup>Because we take the coupling to be infinitesimal, our setup is free from the issues discussed in [113, 114, 115, 116].



derivation of the extremality condition involves accounting for the divergences mentioned above. We find that the extra freedom afforded by our ansatz allows us to cancel all order  $(n-1)$  divergences in the Einstein–Gauss–Bonnet field equations precisely when (3.6) holds. As in the case of general relativity, this is the only constraint on  $\Sigma$ . We also find that the equations of motion allow replica symmetry breaking terms to contribute to the extrinsic curvature at  $n = 1$ , but in a way that preserves (3.6).

## 3.2 Review of the Lewkowycz–Maldacena derivation

In this section we review the generalized gravitational entropy of [21]. The purpose of the generalized entropy is to use holography to compute the von Neumann entropy

$$S(\rho) = -\text{Tr}(\hat{\rho} \log(\hat{\rho})), \quad (3.7)$$

where  $\hat{\rho} = \rho/\text{Tr}[\rho]$  and  $\rho$  is of the form

$$\rho = \mathcal{P} \left( e^{-\int_0^{2\pi} d\tau H(\tau)} \right). \quad (3.8)$$

Here  $H(\tau)$  is the Euclidean Hamiltonian and  $\mathcal{P}$  indicates path ordering. The density matrix  $\rho$  can then be seen as a Euclidean time evolution operator for a time interval of length  $2\pi$ .

If the Hamiltonian does not depend on time then this density matrix is thermal

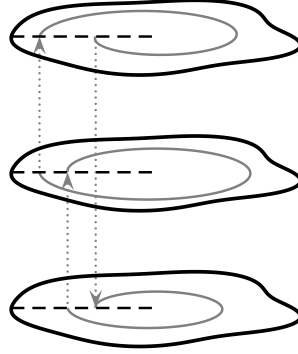

Figure 3.2: A sketch of the  $n = 3$  replica manifold. The three solid black lines represents the  $\tau$  circle of the boundary manifold  $B^3$  and the dashed lines represent cuts at  $\tau = 2\pi k$  for integer  $k$ . The gray line is a closed curve in the bulk  $M^3$  which illustrates how the three slices are glued together along the cuts. The path integral on  $B^3$  computes  $\text{Tr}[\rho^3]$  and provides a geometric realization of the formula (3.9). This path integral can also be expressed as the action associated with the metric  $g^{(3)}$ , a smooth metric that solves the gravitational field equation on  $M^3$ , as in (3.10). Note that even if the state  $\rho^3$  is replica symmetric,  $g^{(3)}$  is not simply three copies of  $g^{(1)}$  glued together, as the latter metric would not be smooth.

and takes the form  $\rho_T = \sum_i e^{-2\pi E_i} |E_i\rangle\langle E_i|$ , in which case the considerations to follow give the usual results of black hole thermodynamics. In the remainder we will focus on the more general class of states (3.8) by allowing Euclidean time-dependent features of the spacetime in the field theory side.

The advantage of restricting to the class of states (3.8) is that they have a geometric representation in the field theory as a path integral over some manifold  $B$ . The Rényi entropies  $S_n$  (defined in (3.3)) of these states can be written as a path integral over a manifold  $B^n$  constructed by gluing together  $n$  copies of the original length manifold  $B$ , with the trace implemented by the identification of

the initial and final cuts (see Fig. 3.2):

$$\mathrm{Tr}[\rho^n] = \mathcal{P} \left( e^{-\int_0^{2\pi n} d\tau H(\tau)} \right) \equiv Z(n). \quad (3.9)$$

The right hand side of this equation refers to the path-integral representation of this quantity as the partition function on a Euclidean manifold with  $\mathbb{Z}_n$  symmetry,  $B^n$ . This replica symmetry is implemented by translating  $\tau$  by multiples of  $2\pi$ :  $\tau \rightarrow \tau + 2\pi s$ ,  $s \in \mathbb{Z}/n\mathbb{Z}$ . This symmetry is enhanced to  $U(1)$  for the thermal state.

Holography maps these field theory calculations to a gravitational computation in one more dimension. In the semiclassical limit we have

$$Z(n) \approx e^{-I_n}, \quad (3.10)$$

where  $I_n$  is the Euclidean action of a gravitational saddle point in one more dimension. We will refer to this geometry as the replica manifold  $(M^n, g^{(n)})$ .<sup>3</sup> The field theory manifold  $B^n$  is identified with the boundary of  $M^n$ , i.e.  $\partial M^n = B^n$ . This boundary  $B^n$  is  $\mathbb{Z}_n$  symmetric by construction, but this symmetry need not extend into the bulk. Whether it does or not is decided dynamically.

The von Neumann entropy (3.7) of the state (3.8) is then computed holographically as:

$$S = -\lim_{n \rightarrow 1} \frac{1}{n-1} \log \left( \frac{e^{-I_n}}{e^{-nI_1}} \right) = \partial_n (I_n - nI_1)|_{n=1}. \quad (3.11)$$

---

<sup>3</sup>Therefore we have  $I_n \equiv I[g^{(n)}]$ .

This expression is subtle. For one thing, it requires a prescription for analytically continuing a function defined over the positive integers  $I_n$ , to a function over the reals. The prescription of Lewkowycz and Maldacena [21] for this continuation can be thought of as a prescription for the analytic continuation of the geometries  $g^{(n)}$ , whose action is  $I_n$ . This procedure requires, *e.g.*, specifying what one means by  $\mathbb{Z}_n$  symmetry for non-integer  $n$ . We will review this below, and see how it leads to well defined computations and familiar results for general relativity in the bulk.

The expression (3.11) can be manipulated into the gravitational action of a conical singularity. To do so, start by absorbing the factor of  $n$  in the second term in the right hand side into the period of Euclidean time:

$$nI_1 = n \int_0^{2\pi} d\tau \mathcal{L}_1 = \int_0^{2\pi n} d\tau \mathcal{L}_1 \equiv I_n[n-1], \quad (3.12)$$

where the brackets indicate that we are calculating the action of a geometry with a conical excess,<sup>4</sup> of strength  $2\pi(n-1)$ —since we have extended the period of  $\tau$ . The benefit of this manipulation is that now the two geometries in the right hand side of (3.11), the one in  $I_n$  and the one in  $I_n[n-1]$ , have the same boundary conditions. One can therefore meaningfully compare their actions. Using the stationarity of  $I_n$  one arrives at

$$S = \partial_n \hat{I}_1[n-1] \Big|_{n=1}. \quad (3.13)$$

The hat on  $\hat{I}$  indicates the contribution to the action of an infinitesimal conical excess. To do this calculation, one first regulates the conical singularity by

---

<sup>4</sup>We should not, however, include any contributions to  $I_n[n-1]$  localized in the singularity.

smoothing the tip of the cone, then calculates the action of the regulated geometry, and finally sends the regulator to zero. For general relativity, this results in  $S = \text{Area}/4G$ , in agreement with (3.1).

If  $g^{(n)}$  is replica symmetric, we can rewrite the argument in the above paragraph in terms of a conical deficit, by manipulating the first term instead of the second one in eq.(3.11), using that

$$I_n = \int_0^{2\pi n} d\tau \mathcal{L}_n = n \int_0^{2\pi} d\tau \mathcal{L}_n = nI_1[1 - n]. \quad (3.14)$$

However, we can not write the second equality if the replica symmetry of the boundary  $\mathbb{Z}_n$  does not extend into the bulk. Therefore, while the derivation of the holographic entanglement entropy functional as the action of a conical excess is robust against the breakdown of  $\mathbb{Z}_n$ , the introduction of a conical defect formally depends on  $g^{(n)}$  being replica symmetric.

To derive an equation of motion for the location of the entropy surface  $\Sigma$ , start by noticing that if the metric  $g^{(n)}$  on  $M^n$  is replica symmetric, then there is a special surface  $\Sigma^n$  in  $M^n$  consisting of fixed points of the  $\mathbb{Z}_n$  symmetry. The calculation of the entropy in terms of a conical deficit naturally localises on this surface, and the entangling surface  $\Sigma$  in  $M^1$  is the limit of  $\Sigma^n$  as  $n \rightarrow 1$ .<sup>5</sup>

$\Sigma$  is however not defined by symmetry in  $M^1$ , as this manifold is not symmetric in general.  $\Sigma$  is instead defined by an equation of motion. To find this equation of motion, consider the analytic continuation of the  $\mathbb{Z}_n$ -symmetric metric  $g^{(n)}$  to

---

<sup>5</sup>For non-integer  $n$  it no longer makes sense to identify  $\tau \sim \tau + 2\pi n$ . If we did, the metric  $g^{(n)}$  would be discontinuous along the cut. The prescription for computing the action in [21] is to integrate over  $\tau \in [0, 2\pi)$  and multiply the result by  $n$ . An alternative analytic continuation which does identify  $\tau \sim \tau + 2\pi n$  was considered in [121].

real  $n$ . A side effect of the analytic continuation is that now the Riemann tensor of  $g^{(n)}$  diverges on the surface  $\Sigma^n$ . However, requiring the equations of motion hold with a finite stress-energy tensor, i.e.

$$E_{\mu\nu}[g^{(n)}] = (\text{finite}), \quad (3.15)$$

where  $E_{\mu\nu}$  are the gravitational field equations, results in a constraint for the location of  $\Sigma^n$ . The limit  $n \rightarrow 1$  of this constraint is the equation of motion for  $\Sigma$ .

The key step in this argument is defining the analytically continued metric  $g^{(n)}$ . To do this it is useful to introduce coordinates adapted to the surface  $\Sigma^n$ . On the  $D$ -dimensional manifold  $M^n$  let  $x^a$  for  $a, b = 1, 2$  be transverse Cartesian coordinates to  $\Sigma^n$  and let  $\sigma^i$  for  $i, j = 3, \dots, D$  be coordinates on  $\Sigma^n$  (see Fig. 3.3). We take  $\Sigma^n$  to be located at  $x^1 = 0 = x^2$ . It will also be useful to work with the polar coordinates

$$r = \sqrt{(x^1)^2 + (x^2)^2}, \quad \tan\left(\frac{\tau}{n}\right) = \frac{x^2}{x^1}, \quad (3.16)$$

and especially the complex coordinate

$$z = x^1 + ix^2 = re^{i\tau/n}, \quad \bar{z} = x^1 - ix^2 = re^{-i\tau/n}. \quad (3.17)$$

Lewkowycz and Maldacena define  $g^{(n)}$  by working out an expansion of the metric

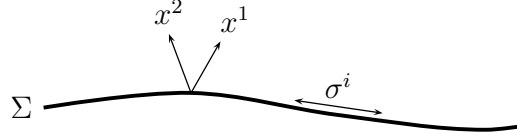

Figure 3.3: A sketch of the coordinates used in the text.  $\Sigma$  is the codimension-two entropy surface. In our coordinates,  $\Sigma$  is located at  $x^1 = 0 = x^2$  and points on its surface are described by the  $D - 2$  coordinates  $\sigma^i$ .

in powers of the distance to  $\Sigma^n$ :

$$g_{\mu\nu}^{(n)} dy^\mu dy^\nu = dz d\bar{z} + 2A_{iz\bar{z}}(\bar{z}dz - zd\bar{z})d\sigma^i + (\gamma_{ij} + 2K_{ijz}z^n + 2K_{ij\bar{z}}\bar{z}^n) d\sigma^i d\sigma^j + \dots, \quad (3.18)$$

where the dots denote terms that become  $O(|z|^2)$  as  $n \rightarrow 1$ . The metric  $g^{(n)}$  is explicitly regular at integer  $n$ , as it contains only non-negative integer powers of the coordinates, and is invariant under  $\mathbb{Z}_n$  transformations  $z \rightarrow z e^{i2\pi s/n}$ . The fixed points of this replica symmetry form the codimension-two surface  $\Sigma^n$ , at  $r = 0$ .

A short calculation reveals that the Riemann tensor of  $g^{(n)}$  has a singularity at  $\Sigma^n$  for  $n \sim 1$ :

$$R_{izjz} = -\frac{n-1}{z} K_{ijz} z^{n-1}, \quad (3.19)$$

which propagates only to the  $zz$  components of the Ricci tensor (and  $\bar{z}\bar{z}$  by complex conjugation). Demanding that this singularity in the Ricci vanishes by (3.15),

one finds

$$\gamma^{ij} K_{ijz} = 0. \quad (3.20)$$

Upon sending  $n \rightarrow 1$  in the metric  $g^{(n)}$ ,  $K_{ijz}$  becomes the extrinsic curvatures of  $\Sigma$ ,  $\mathcal{K}_{ijz}$ , and (3.20) becomes the equations of motion for an extremal area surface, in agreement with the Ryu–Takayangi formula. This completes our review of the generalized entropy of Lewkowycz and Maldacena.

### 3.3 Deriving the surface equations of motion without replica symmetry

In this section we will generalize the metric (3.18) to allow for replica symmetry breaking terms as well as more general replica symmetric ones. In section 3.4 these generalizations will prove to be crucial ingredients for the solution of the field equations (3.15) in Einstein–Gauss–Bonnet gravity. Since  $\Sigma^n$  is defined in [21] as the set of fixed points of the replica symmetry, part of the task of this section is to define  $\Sigma$  without assuming replica symmetry.

#### 3.3.1 Defining the replica manifold

As reviewed in section 3.2, the key step in Lewkowycz and Maldacena’s argument is defining the analytically continued metric  $g^{(n)}$ . Once the metric  $g^{(n)}$  is given, the location of  $\Sigma^n$  is restricted by the field equations (3.15). Lewkowycz and Maldacena are able to learn what they need to know about  $g^{(n)}$  and  $\Sigma^n$  by



assuming (3.18) and working to leading order in an expansion in powers of  $(n-1)$ .

We will perform the same calculation using a more general boundary condition for the surface  $\Sigma^n$ . As mentioned above our boundary condition will allow  $g^{(n)}$  to break replica symmetry. For solutions which happen to be replica symmetric we can think of our calculation as a technical generalization of Lewkowycz–Maldacena, but for replica symmetry breaking  $g^{(n)}$  we must supply a new definition of the surface  $\Sigma^n$ . In this case we define the metric by a boundary condition on a bulk surface which we call  $\Sigma^n$ . One way to state our boundary condition is that we only allow terms which individually preserve some discrete symmetry on  $M^n$  for integer  $n$  (though different terms need not preserve the same discrete symmetry). The surface  $\Sigma^n$  is then the set of common fixed points of all of these discrete symmetries. This, together with regularity at integer  $n$ , fixes the boundary condition for  $g^{(n)}$  around  $\Sigma^n$ .

We require that the metric near  $\Sigma^n$  takes the form<sup>6</sup>

$$\begin{aligned}
g_{\mu\nu}^{(n)} dy^\mu dy^\nu &= dz d\bar{z} + \left[ \hat{L}_{z\bar{z}z}^{(n)} z + \hat{L}_{z\bar{z}\bar{z}}^{(n)} \bar{z} + \text{c.c.} \right] dz d\bar{z} + \left[ (\hat{L}_{z\bar{z}z}^{(n)} z + \hat{L}_{z\bar{z}\bar{z}}^{(n)} \bar{z}) dz dz + \text{c.c.} \right] \\
&\quad + 2 \left[ (\hat{A}_{izz}^{(n)} z + \hat{A}_{izz}^{(n)} \bar{z}) dz d\sigma^i + \text{c.c.} \right] + \left( \gamma_{ij} + \left[ 2\hat{K}_{ijz}^{(n)} z + \text{c.c.} \right] \right) d\sigma^i d\sigma^j,
\end{aligned}
\tag{3.21}$$

---

<sup>6</sup>In fact, it is natural to generalize (3.21) slightly, see (3.43) below. For the benefit of readability we postpone this discussion to section 3.4. The solution we find for general relativity is therefore a special case of our most general ansatz in which we have set  $\gamma_{ij}^{(m,\bar{m})} = 0$  for non-zero  $m$  or  $\bar{m}$ .

where

$$\begin{aligned}
\hat{K}_{ijz}^{(n)} &= \sum_{(m,\bar{m}) \neq (0,0)} z^{m(n-1)} \bar{z}^{\bar{m}(n-1)} K_{ijz}^{(m,\bar{m})} + \dots \\
\hat{A}_{izz}^{(n)} &= \sum_{(m,\bar{m}) \neq (0,0)} z^{m(n-1)} \bar{z}^{\bar{m}(n-1)} A_{izz}^{(m,\bar{m})} + \dots \\
\hat{A}_{iz\bar{z}}^{(n)} &= \sum_{(m,\bar{m}) \geq (0,0)} z^{m(n-1)} \bar{z}^{\bar{m}(n-1)} A_{iz\bar{z}}^{(m,\bar{m})} + \dots \\
\hat{L}_{abz}^{(n)} &= \sum_{(m,\bar{m}) \neq (0,0)} z^{m(n-1)} \bar{z}^{\bar{m}(n-1)} L_{abz}^{(m,\bar{m})} + \dots
\end{aligned} \tag{3.22}$$

Here dots denote terms that become  $O(|z|)$  as  $n \rightarrow 1$  and the coefficients in the expansions may depend on the  $\sigma^i$ . The remaining metric functions are given by reality conditions. Reality also implies

$$\begin{aligned}
K_{ij\bar{z}}^{(m,\bar{m})} &= \bar{K}_{ijz}^{(\bar{m},m)}, & A_{iz\bar{z}}^{(m,\bar{m})} &= \bar{A}_{izz}^{(\bar{m},m)}, & A_{iz\bar{z}}^{(m,\bar{m})} &= \bar{A}_{iz\bar{z}}^{(\bar{m},m)}, \\
L_{\bar{z}\bar{z}\bar{z}}^{(m,\bar{m})} &= \bar{L}_{zzz}^{(\bar{m},m)}, & L_{zzz}^{(m,\bar{m})} &= \bar{L}_{\bar{z}\bar{z}\bar{z}}^{(\bar{m},m)}, & L_{z\bar{z}\bar{z}}^{(m,\bar{m})} &= \bar{L}_{z\bar{z}\bar{z}}^{(\bar{m},m)}.
\end{aligned} \tag{3.23}$$

We generally use an overbar as shorthand for complex conjugation—except for  $m$  and  $\bar{m}$  which are independent non-negative integers.

The boundary condition (3.21) is explicitly regular at integer  $n$  and only contains first powers of  $(n-1)$ . In (3.22) we explicitly wrote out the leading order terms in a power series about  $z=0$ . More precisely, we collected all terms that contribute to potential divergences in the field equations at the same rate as the singularities allowed by (3.18). Note that the limits in the sums in (3.22) exclude terms that would break replica symmetry completely, as  $K_{ijz}^{(0,0)}$ . This would be an extrinsic curvature of  $\Sigma^n$  at all integer  $n$ , and therefore would not preserve

any subsymmetry. Said differently, for any integer  $n$  this term would be invariant under  $z \rightarrow z e^{i2\pi/p}$  only for  $p = 1$ . Aside from breaking replica symmetry, the main technical innovation of (3.21) is that we have analytically continued terms which can be gauged away when  $n = 1$ :  $L_{abc}$ ,  $A_{izz}$  and the real part of  $A_{izz\bar{z}}$ . This provides us with greater freedom to solve the equations of motion without over constraining the location of the surface  $\Sigma$ .

Note that of the terms appearing in (3.22), only the following preserve replica symmetry

$$K_{ijz}^{(k+1,k)}, \quad A_{izz\bar{z}}^{(k,k)}, \quad A_{izz}^{(k+2,k)}, \quad L_{z\bar{z}z}^{(k+1,k)}, \quad L_{zzz}^{(k+3,k)}, \quad L_{zz\bar{z}}^{(k+1,k)}, \quad (3.24)$$

(and their complex conjugates) for any integer  $k$ . In other words, a solution that contains only these terms will be invariant under  $\tau \rightarrow \tau + 2\pi$  when  $n$  is an integer. All of these terms are therefore allowed when assuming replica symmetry, and we can see their inclusion as a natural generalization of the ansatz in (3.18).

Following [21] we will solve the field equations to leading order in  $(n - 1)$ . However, before doing so we must specify how we will handle the factors of  $z^{m(n-1)}\bar{z}^{\bar{m}(n-1)}$  appearing in (3.22). Our prescription will be to preserve the structure of our expansion when solving the equations of motion. For example we maintain

$$z^{n-1} \not\sim 1 + O(n - 1), \quad (3.25)$$

as well as

$$\frac{(n-1)}{z}(z^{n-1} - \bar{z}^{n-1}) \not\sim O(n-1)^2, \quad (3.26)$$

even at leading order in  $(n-1)$ . Keeping this structure gives us well constrained equations of motion that fix all of the terms in the power series (3.22). Less restrictive conditions either give ambiguous results for the equation of motion of  $\Sigma$  or allow seemingly unphysical cancellations between terms which have different angular dependence at finite  $(n-1)$ .<sup>7</sup>

Inserting the power series (3.22) into the field equations will give us a set of constraints on the metric components. We derive these constraints for general relativity below.

### 3.3.2 Deriving the extremal area condition

In this section we derive the extremal area condition  $\mathcal{K}^a = 0$  for Einstein gravity using our ansatz (3.21). Here  $\mathcal{K}_{ij}{}^a$  is the extrinsic curvature of  $\Sigma$  and  $\mathcal{K}^a = \gamma^{ij}\mathcal{K}_{ij}{}^a$  is its trace. Because one of our main results pertains to perturbative Einstein–Gauss–Bonnet, many of the expressions in this section will be used again in section 3.4.

Divergences only arise in the curvature of (3.21) after taking two transverse

---

<sup>7</sup>Note that (3.26) would be natural if we complexified the manifold and thought of  $z, \bar{z}$  as independent coordinates, though we know of no natural reason to do so.

derivatives of the metric. Thus we may write the Ricci tensor as

$$\begin{aligned}
R_{ij} &= -2\partial\bar{\partial}g_{ij} + \dots \\
R_{zz} &= -\frac{1}{2}g^{ij}\partial\bar{\partial}g_{ij} + \dots \\
R_{iz} &= \partial\bar{\partial}g_{i\bar{z}} - \partial\bar{\partial}g_{iz} + \dots \\
R_{z\bar{z}} &= -\frac{1}{2}g^{ij}\partial\bar{\partial}g_{ij} + \partial\bar{\partial}g_{z\bar{z}} + \bar{\partial}\bar{\partial}g_{zz} - 2\partial\bar{\partial}g_{z\bar{z}} + \dots, \tag{3.27}
\end{aligned}$$

where  $\partial = \partial_z$ ,  $\bar{\partial} = \partial_{\bar{z}}$ , and  $\dots$  denote finite terms as  $z \rightarrow 0$ . Inserting the power series expansion (3.22) into (3.27) gives a general expression that is conveniently expressed as

$$R_{\mu\nu} = \sum_{m, \bar{m} \geq 0} R_{\mu\nu}^{(m, \bar{m})} z^{m(n-1)} \bar{z}^{\bar{m}(n-1)}, \tag{3.28}$$

with the following structure of divergences at the origin

$$R_{ij}^{(m, \bar{m})} = -4(n-1) \left( \frac{\bar{m}}{\bar{z}} K_{ijz}^{(m, \bar{m})} + \frac{m}{z} K_{ij\bar{z}}^{(m, \bar{m})} \right) \tag{3.29a}$$

$$R_{zz}^{(m, \bar{m})} = -(n-1) \left( \frac{m}{z} K_z^{(m, \bar{m})} - \frac{m\bar{z}}{z^2} K_{\bar{z}}^{(m, \bar{m})} \right) \tag{3.29b}$$

$$R_{iz}^{(m, \bar{m})} = -(n-1) \left( \frac{\bar{m}}{\bar{z}} A_{izz}^{(m, \bar{m})} - \frac{m}{z} (A_{i\bar{z}z}^{(m, \bar{m})} - A_{iz\bar{z}}^{(m, \bar{m})}) + \frac{m\bar{z}}{z^2} A_{i\bar{z}\bar{z}}^{(m, \bar{m})} \right) \tag{3.29c}$$

$$R_{z\bar{z}}^{(m, \bar{m})} = \frac{\gamma^{ij} R_{ij}^{(m, \bar{m})}}{4} - (n-1) \left[ -\frac{m}{z} L_{\bar{z}\bar{z}z}^{(m, \bar{m})} + \frac{2\bar{m}}{\bar{z}} L_{z\bar{z}z}^{(m, \bar{m})} + \frac{\bar{m}z}{\bar{z}^2} L_{zzz}^{(m, \bar{m})} + \text{c.c.} \right], \tag{3.29d}$$

where  $K_z^{(m, \bar{m})} = \gamma^{ij} K_{ijz}^{(m, \bar{m})}$ , and we left implicit components that follow by complex conjugation. The field equations demand that all of the terms in (3.29) vanish.

The constraints from (3.29a) and (3.29b) are

$$K_z^{(m,\bar{m})} = 0, \quad K_{ijz}^{(m,\bar{m} \neq 0)} = 0. \quad (3.30)$$

Note that the  $K_{ijz}^{(m,0)}$ , including the leading order replica symmetric term  $K_{ijz}^{(1,0)}$ , must be traceless but are otherwise unconstrained. Next, (3.29c) requires that

$$A_{izz}^{(m,\bar{m} \neq 0)} = 0, \quad A_{izz}^{(m \neq 0, \bar{m})} = A_{i\bar{z}\bar{z}}^{(m \neq 0, \bar{m})}. \quad (3.31)$$

Here we find that the terms  $A_{izz}^{(m,0)}$  and  $A_{i\bar{z}\bar{z}}^{(0,\bar{m})}$  are completely unrestrained. Finally (3.29d) and (3.30) imply that

$$L_{z\bar{z}\bar{z}}^{(m \neq 0, \bar{m})} = 0, \quad L_{z\bar{z}\bar{z}}^{(m, \bar{m} \neq 0)} = 0, \quad L_{zzz}^{(m, \bar{m} \neq 0)} = 0, \quad (3.32)$$

which means that  $L_{z\bar{z}\bar{z}}^{(m,0)}$  and  $L_{zzz}^{(m,0)}$  are unrestricted. Note that the constraints (3.30), (3.31), and (3.32) do not single out replica symmetric terms in any obvious way (see (3.24)).

Now that we have solved the field equations in terms of  $\hat{K}_{ijz}^{(n)}$ ,  $\hat{A}_{izz}^{(n)}$ ,  $\hat{A}_{i\bar{z}\bar{z}}^{(n)}$  and  $\hat{L}_{abz}^{(n)}$ , we take  $n \rightarrow 1$  and interpret  $\hat{K}_{ijz}^{(1)}$ ,  $\hat{A}_{izz}^{(1)}$ ,  $\hat{A}_{i\bar{z}\bar{z}}^{(1)}$  and  $\hat{L}_{abz}^{(1)}$  as metric functions of  $g^{(1)}$ . This gives

$$\begin{aligned} \hat{K}_{ijz}^{(1)} &= \sum_{(m,\bar{m}) \neq (0,0)} K_{ijz}^{(m,\bar{m})} z \\ \hat{A}_{izz}^{(1)} &= \sum_{(m,\bar{m}) \neq (0,0)} A_{izz}^{(m,\bar{m})} z, & \hat{A}_{i\bar{z}\bar{z}}^{(1)} &= \sum_{(m,\bar{m}) \geq (0,0)} A_{i\bar{z}\bar{z}}^{(m,\bar{m})} \bar{z} \\ \hat{L}_{abz}^{(1)} &= \sum_{(m,\bar{m}) \neq (0,0)} L_{abz}^{(m,\bar{m})} z, & \hat{L}_{ab\bar{z}}^{(1)} &= \sum_{(m,\bar{m}) \neq (0,0)} L_{ab\bar{z}}^{(m,\bar{m})} \bar{z}. \end{aligned} \quad (3.33)$$

Applying the constraints (3.31) and (3.32) we see that  $\hat{A}_{izz}^{(1)}$ ,  $\hat{A}_{iz\bar{z}}^{(1)}$  and  $\hat{L}_{z\bar{z}z}^{(1)}$ ,  $\hat{L}_{zzz}^{(1)}$  are unrestricted by the equations of motion. This follows immediately from the fact that  $A_{izz}^{(m,0)}$ ,  $A_{iz\bar{z}}^{(0,0)}$ ,  $L_{z\bar{z}z}^{(0,\bar{m})}$ ,  $L_{z\bar{z}z}^{(m,0)}$ ,  $L_{zzz}^{(m,0)}$  are all free of constraints. Similarly  $\hat{K}_{ijz}^{(1)}$  is only required to satisfy  $\hat{K}_z^{(1)} = 0$ . The form of our ansatz dictates that  $\mathcal{K}_a = \hat{K}_a^{(1)}$ , therefore we have

$$\mathcal{K}^a = 0, \tag{3.34}$$

as predicted by the Ryu–Takayanagi formula (3.2).

## 3.4 Generalized entropy for Einstein–Gauss–Bonnet Gravity

We now compute the correction to the construction in the previous section under the addition of a perturbative Gauss–Bonnet coupling  $\lambda$  in the gravitational equations of motion. As explained in the introduction, we choose Gauss–Bonnet corrections for technical convenience and regard (3.4) as a toy model for stringy  $\alpha'$  corrections.

We take the Lewkowycz–Maldacena replica symmetric solution (3.18) to be the zeroth order term in a  $\lambda$  expansion. To first order, there is the same possibility of breaking replica symmetry that we found in the previous section. The key ingredient for this derivation is the same as in general relativity, namely demanding absence of singularities in the gravitational field equations to linear order in  $(n - 1)$ .

### 3.4.1 Linearized Einstein–Gauss–Bonnet gravity

The field equations derived from the action (3.4) read

$$R_{\mu\nu} - \lambda H_{\mu\nu} = (\text{finite}), \quad (3.35)$$

where the right hand side is constructed from the matter stress tensor, which is assumed to be finite, and  $H_{\mu\nu}$  is defined as

$$\begin{aligned} H_{\mu\nu} = & -2R_{\mu}{}^{\rho\sigma\xi} R_{\nu\rho\sigma\xi} + 4R^{\rho\sigma} R_{\rho\mu\sigma\nu} + 4R_{\mu}{}^{\rho} R_{\nu\rho} - 2RR_{\mu\nu} \\ & + \frac{1}{D-2} g_{\mu\nu} (R_{\mu\nu\rho\sigma} R^{\mu\nu\rho\sigma} - 4R_{\mu\nu} R^{\mu\nu} + R^2). \end{aligned} \quad (3.36)$$

The fact that  $H_{\mu\nu}$  does not contain derivatives of the Riemann tensor is the technical reason why we choose to study this and not any other correction to general relativity.

We now expand the metric in powers of  $\lambda$  as

$$g_{\mu\nu}^{(n)} = \tilde{g}_{\mu\nu}^{(n)} + \lambda \delta g_{\mu\nu}^{(n)} + O(\lambda^2), \quad (3.37)$$

where the first term  $\tilde{g}_{\mu\nu}^{(n)}$  is the replica symmetry preserving solution of Lewkowycz and Maldacena (3.18).

We must now solve

$$R_{\mu\nu}[\delta g^{(n)}] = H_{\mu\nu}[\tilde{g}^{(n)}]. \quad (3.38)$$

To compute  $H_{\mu\nu}[\tilde{g}^{(n)}]$  we need to know the Riemann tensor of  $\tilde{g}^{(n)}$ . Expanding



the metric at one order higher than in (3.18) we obtain

$$\begin{aligned} \tilde{g}_{\mu\nu}^{(n)} dy^\mu dy^\nu &= \left( \tilde{\gamma}_{ij} + \left[ 2\tilde{K}_{ijz} z^n + \tilde{Q}_{ijzz} z^{2n} + \tilde{Q}_{ijz\bar{z}} z\bar{z} + \text{c.c.} \right] \right) d\sigma^i d\sigma^j + 2\tilde{A}_{iz\bar{z}} (\bar{z}dz - zd\bar{z}) d\sigma^i \\ &\quad - \frac{4}{3} \left[ \tilde{R}_{izzz} z^n - \text{c.c.} \right] (\bar{z}dz - zd\bar{z}) d\sigma^i + \left( dz d\bar{z} - \frac{1}{3} \tilde{R}_{z\bar{z}z\bar{z}} (\bar{z}dz - zd\bar{z})^2 \right) + \dots \end{aligned} \quad (3.39)$$

Here the dots stand for terms that become  $O(|z|^3)$  when  $n \rightarrow 1$ , and c.c. stands for complex conjugation. We introduced the object  $\tilde{Q}$ ,<sup>8</sup> with properties  $\tilde{Q}_{ijab} = \tilde{Q}_{ijba} = \tilde{Q}_{jiab}$ . The metric (3.39) is explicitly replica symmetric and regular at integer  $n \geq 1$ .

To leading order in  $(n-1)$ , the components of the Riemann tensor of (3.39) are<sup>9</sup>

$$\begin{aligned} R_{ij}{}^{kl} &= \tilde{\mathcal{R}}_{ij}{}^{kl} - 4(z\bar{z})^{n-1} \tilde{K}_i{}^{[k} \tilde{K}^{l]}{}_{j\bar{z}} - 4(z\bar{z})^{n-1} \tilde{K}_i{}^{[k} \tilde{K}^{l]}{}_{\bar{z}j} \\ R_{ijk}{}^{\bar{z}} &= z^{n-1} \tilde{R}_{ijk}{}^{\bar{z}} = 2z^{n-1} \left( \tilde{\nabla}_{[i} \tilde{K}_{j]k}{}^{\bar{z}} + \tilde{A}_{[i}{}^{\bar{z}z} \tilde{K}_{j]kz} \right) \\ R_{ij}{}^{z\bar{z}} &= \tilde{F}_{ij}{}^{z\bar{z}} - 2(z\bar{z})^{n-1} \tilde{K}_{[i}{}^{kz} \tilde{K}_{j]k}{}^{\bar{z}} \\ R_i{}^z{}_j{}^{\bar{z}} &= \frac{1}{2} \tilde{F}_{ij}{}^{z\bar{z}} - \frac{1}{2} \tilde{A}_i{}^{z\bar{z}} \tilde{A}_j{}^{z\bar{z}} - \tilde{Q}_{ij}{}^{z\bar{z}} + (z\bar{z})^{n-1} \tilde{K}_i{}^{kz} \tilde{K}_{jk}{}^z \\ R_{izjz} &= -\frac{n-1}{z} \tilde{K}_{ijz} z^{n-1} + z^{2(n-1)} \tilde{K}_i{}^k{}_z \tilde{K}_{jkz} - z^{2(n-1)} \tilde{Q}_{ijzz} \\ R_{izz\bar{z}} &= z^{n-1} \tilde{R}_{izz\bar{z}} \\ R_{z\bar{z}z\bar{z}} &= \tilde{R}_{z\bar{z}z\bar{z}}. \end{aligned} \quad (3.40)$$

The remaining components are related to those above by complex conjugation

<sup>8</sup>In [104]  $Q$  is called  $\tilde{K}$ .

<sup>9</sup>In this expansion we only keep the terms that are either finite as  $n \rightarrow 1$  or proportional to  $(n-1)$  but divergent as  $|z| \rightarrow 0$ .

and symmetries of the indices. We defined  $\tilde{F}_{ijz\bar{z}} = -\tilde{F}_{ij\bar{z}z} \equiv \partial_i \tilde{A}_{jz\bar{z}} - \partial_j \tilde{A}_{iz\bar{z}}$ , which is purely imaginary.  $\tilde{\mathcal{R}}_{ijkl}$  is the curvature of the metric  $\tilde{\gamma}_{ij}$  on  $\Sigma^n$ , with covariant derivative  $\tilde{\nabla}_i$ . Some of the equations (3.40) become familiar Gauss-Codacci relations for  $\Sigma$  upon taking the limit  $n \rightarrow 1$ .

We are now ready to write the source term  $H_{\mu\nu}[\tilde{g}^{(n)}]$ . In the series expansion

$$H_{\mu\nu} = \sum_{m, \bar{m} \geq 0} H_{\mu\nu}^{(m, \bar{m})} z^{m(n-1)} \bar{z}^{\bar{m}(n-1)} \quad (3.41)$$

the singular terms in  $H_{\mu\nu}$  are given by

$$H_{ij}^{(2,1)} = 4 \frac{(n-1)}{\bar{z}} \left( \tilde{K}_{ik\bar{z}} \tilde{R}_j^{\bar{z}k\bar{z}} + \tilde{K}_{jk\bar{z}} \tilde{R}_i^{\bar{z}k\bar{z}} - \tilde{K}_{ijz} \tilde{R}_k^{\bar{z}k\bar{z}} \right) - 8 \frac{(n-1)}{\bar{z}} \frac{\tilde{K}_{kl\bar{z}} \tilde{R}^{k\bar{z}l\bar{z}}}{D-2} \tilde{\gamma}_{ij} \quad (3.42a)$$

$$H_{zz}^{(1,0)} = -4 \frac{(n-1)}{z} \tilde{K}_{ijz} \tilde{\mathcal{R}}^{ikj}_k \quad (3.42b)$$

$$H_{z\bar{z}}^{(2,1)} = -8 \frac{(n-1)}{z} \tilde{K}_{ijz} \left( \tilde{K}^i_{kz} \tilde{K}^{jk}_{\bar{z}} + \tilde{K}^j_{kz} \tilde{K}^{ik}_{\bar{z}} \right) \quad (3.42c)$$

$$H_{z\bar{z}}^{(2,1)} = 2 \frac{(n-1)}{\bar{z}} \frac{D-4}{D-2} \tilde{K}_{ij\bar{z}} \tilde{R}^{i\bar{z}j\bar{z}} \quad (3.42d)$$

$$H_{iz}^{(1,1)} = 4 \frac{(n-1)}{z} \left( \tilde{K}_{ijz} \tilde{R}_k^{jkz} - \tilde{K}_{jkz} \tilde{R}_i^{jkz} \right), \quad (3.42e)$$

where we defined  $\tilde{R}_{i\bar{z}k\bar{z}} = 4 \lim_{n \rightarrow 1} R_{izkz}$ . There are several things to note about these sources. First, we have collected only terms linear in  $(n-1)$ , as this is the only dependence on which we have control. Said differently, we obtained  $H_{\mu\nu}$  by squaring the Riemann tensor of the Lewkowycz–Maldacena solution (3.18). However, we only calculated the Riemann to leading order in  $(n-1)$ , so it does not obviously make sense to include  $(n-1)^2$  terms (3.42).

Note also that, as emphasized in the introduction,  $H_{\mu\nu}$  generically diverges in

all components, in contrast to the divergence in the Lewkowycz–Maldacena Ricci tensor coming from (3.19), which diverges only in the  $zz$  (and  $\bar{z}\bar{z}$ ) components. This immediately implies that to cancel all divergences in the Einstein–Gauss–Bonnet equations of motion we need more ingredients than the ones we used in section 3.2.

Finally, note also that now there is more structure in the potential divergences of the equations of motion. Namely, the divergence in the  $H_{zz}$  component has two sources,  $H_{zz}^{(1,0)}$  and  $H_{zz}^{(2,1)}$ , as observed in [108, 103]. We will demand that these terms cancel separately as explained at the end of section 3.3.1.

### 3.4.2 Solving the field equations

We now solve the perturbative field equations (3.38). It is necessary to start by further generalizing the boundary condition (3.21) by allowing the induced metric  $\delta\gamma_{ij}$  in  $\delta g^{(n)}$  to take the form

$$\delta\gamma_{ij} \rightarrow \sum_{m, \bar{m} \geq 0} \delta\gamma_{ij}^{(m, \bar{m})} z^{m(n-1)} \bar{z}^{\bar{m}(n-1)}. \quad (3.43)$$

These new terms preserve replica symmetry when  $m = \bar{m}$ . They are built with the first power of  $(n-1)$ , and are explicitly regular at integer  $n$ , so they are naturally allowed by the requirements of sec. 3.3 (see footnote 6 above).

Besides naturalness, there are two main uses of the generalization (3.43). First, these terms are needed to solve the equations of motion as we will see shortly. Second, the field equations suggest that terms like those in (3.43) might be natural beyond first order in  $(n-1)$ . This is because  $H_{\mu\nu}$  contains Riemann squared terms

which include the square of (3.19). Therefore  $H_{\mu\nu}$  diverges like  $(n-1)^2 z^{-2}$  and beyond leading order in  $(n-1)$  so must  $R_{\mu\nu}[\delta g]$ . The addition of the  $\gamma_{ij}^{(m,\bar{m})}$  allows for precisely these divergences.

With the addition of these new terms, (3.29) is modified as follows<sup>10</sup>

$$R_{ij}^{(m,\bar{m})} = -\frac{(n-1)}{z} 4m \left( \delta K_{ij\bar{z}}^{(m,\bar{m})} - \delta\gamma_{k(i}^{(m,\bar{m}-1)} \tilde{K}^k{}_{j)\bar{z}} \right) - \frac{(n-1)}{\bar{z}} 4\bar{m} \left( \delta K_{ijz}^{(m,\bar{m})} - \delta\gamma_{k(i}^{(m-1,\bar{m})} \tilde{K}^k{}_{j)z} \right) \quad (3.44a)$$

$$R_{zz}^{(m,\bar{m})} = \frac{(n-1)}{2z^2} m \tilde{\gamma}^{ij} \delta\gamma_{ij}^{(m,\bar{m})} - \frac{(n-1)}{z} \left( m \delta K_z^{(m,\bar{m})} - \delta\gamma_{ij}^{(m-1,\bar{m})} \tilde{K}^{ij}{}_z \right) + \frac{(n-1)\bar{z}}{z^2} m \left( \delta K_{\bar{z}}^{(m,\bar{m})} - \delta\gamma_{ij}^{(m,\bar{m}-1)} \tilde{K}^{ij}{}_{\bar{z}} \right) \quad (3.44b)$$

$$R_{iz}^{(m,\bar{m})} = \frac{(n-1)}{z} m \left[ \frac{1}{2} \left( \tilde{\nabla}^j \delta\gamma_{ji}^{(m,\bar{m})} + 2\tilde{A}^j{}_{z\bar{z}} \delta\gamma_{ij}^{(m,\bar{m})} \right) - \left( \delta A_{iz\bar{z}}^{(m,\bar{m})} - \delta A_{i\bar{z}z}^{(m,\bar{m})} \right) \right] - \frac{(n-1)}{\bar{z}} \bar{m} \delta A_{izz}^{(m,\bar{m})} - \frac{(n-1)\bar{z}}{z^2} m \delta A_{i\bar{z}\bar{z}}^{(m,\bar{m})} \quad (3.44c)$$

$$R_{z\bar{z}}^{(m,\bar{m})} = -\frac{(n-1)}{z} \left( m \delta K_{\bar{z}}^{(m,\bar{m})} - \frac{1}{2} \delta\gamma_{ij}^{(m,\bar{m}-1)} \tilde{K}^{ij}{}_{\bar{z}} \right) - \frac{(n-1)}{\bar{z}} \left( \bar{m} \delta K_z^{(m,\bar{m})} - \frac{1}{2} \delta\gamma_{ij}^{(m-1,\bar{m})} \tilde{K}^{ij}{}_z \right) + \delta L \quad (3.44d)$$

where we used the condition  $m \tilde{\gamma}^{ij} \delta\gamma_{ij}^{(m,\bar{m})} = 0$  to simplify some of the above expressions. This follows from the cancellation of the only  $1/z^2$  divergence, in (3.44b). We also used that in the Lewkowycz–Maldacena solution  $\tilde{L}_{abc} = 0$ ,  $\tilde{A}_{izz} = \tilde{A}_{i\bar{z}\bar{z}} = 0$ ,  $\tilde{A}_{iz\bar{z}} = -\tilde{A}_{i\bar{z}z}$  and  $\tilde{K}_z = 0$ . The term  $\delta L$  in (3.44d) means

<sup>10</sup>The aesthetic reason for not including the  $\delta\gamma_{ij}^{(m,\bar{m})}$  in sec. 3.3 was that  $\delta\gamma \cdot K$  terms generically appear in the rhs of eqs. (3.29) inside a convolution sum (and so do  $\delta\gamma \cdot A$ ,  $\delta\gamma \cdot L$  and  $\delta\gamma \cdot \gamma$ ). There is only one such term in (3.44) because we are perturbing (3.18), for which the convolution collapses: of all the  $\tilde{K}_{ijz}^{(m,\bar{m})}$  only  $\tilde{K}_{ijz}^{(1,0)}$  are non-zero, etc.

substituting the  $L$  terms of (3.29d) with  $L \rightarrow \delta L$ .

Now we solve the field equation (3.38). Starting with the ‘ $zz$ ’ component we find that the cancelation of the  $1/z$  divergence in the  $(1, 0)$  term requires

$$\delta K_z^{(1,0)} - \delta\gamma_{ij}^{(0,0)} \tilde{K}^{ij}_z = 4\tilde{\mathcal{R}}^{ij} \tilde{K}_{ijz}, \quad (3.45)$$

and the one in the  $(2, 1)$  term requires

$$2\delta K_z^{(2,1)} - \delta\gamma_{ij}^{(1,1)} \tilde{K}^{ij}_z = 8\tilde{K}_{ijz} \left( \tilde{K}^i_{kz} \tilde{K}^{jk}_{\bar{z}} + \tilde{K}^j_{kz} \tilde{K}^{ik}_{\bar{z}} \right). \quad (3.46)$$

For all other values of  $(m, \bar{m})$  the cancelation of this divergence gives

$$m \delta K_z^{(m,\bar{m})} - \delta\gamma_{ij}^{(m-1,\bar{m})} \tilde{K}^{ij}_z = 0, \quad (3.47)$$

while the  $\bar{z}/z^2$  divergence implies

$$\delta K_z^{(m,\bar{m} \neq 0)} - \delta\gamma_{ij}^{(m-1,\bar{m} \neq 0)} \tilde{K}^{ij}_z = 0. \quad (3.48)$$

Note that eqs. (3.47) and (3.48) are compatible and imply that, except for the  $(2, 1)$  component,  $\delta K_z^{(m,\bar{m} \neq 0)} = 0$  and  $\delta\gamma_{ij}^{(m-1,\bar{m} \neq 0)} \tilde{K}^{ij}_z = 0$ .

For terms with  $\bar{m} = 0$ , canceling the  $1/\bar{z}$  divergence of the ‘ $z\bar{z}$ ’ component demands

$$\delta\gamma_{ij}^{(m,0)} \tilde{K}^{ij}_z = 0. \quad (3.49)$$

Combining this relation with (3.47) gives

$$\delta K_z^{(m,0)} = 0. \quad (3.50)$$

Combining (3.45) and (3.48)-(3.50) gives

$$\delta K_z^{(m+1,\bar{m})} - \delta \gamma_{ij}^{(m,\bar{m})} \tilde{K}^{ij}{}_z = (4\tilde{\mathcal{R}}^{ij} \tilde{K}_{ijz}) \delta^{m,0} \delta^{\bar{m},0}. \quad (3.51)$$

Next, the  $1/\bar{z}$  divergence in the ‘ $ij$ ’ equation requires that

$$-\frac{4(n-1)}{\bar{z}} \left( \delta K_{ijz}^{(2,1)} - \delta \gamma_{k(i}^{(1,1)} \tilde{K}^k{}_{j)z} \right) = H_{ij}^{(2,1)}, \quad (3.52)$$

which determines  $\delta K_{ijz}^{(2,1)}$  in terms of  $\delta \gamma_{k(i}^{(1,1)} \tilde{K}^k{}_{j)z}$ . Note that the trace of (3.52) would be inconsistent with (3.48) if not for the fact that  $\tilde{\gamma}^{ij} H_{ij}^{(2,1)} = 0$ , which can easily be seen from (3.42a).

The ‘ $iz$ ’ equation can be solved with a  $\delta A_{iz\bar{z}}^{(1,1)} = -\delta A_{i\bar{z}z}^{(1,1)}$  term. The results above imply that  $\delta K_z^{(m,\bar{m})}$  and  $\delta \gamma_{ij}^{(m,\bar{m})}$  drop from the ‘ $z\bar{z}$ ’ equation, that can be solved by  $\delta L_{z\bar{z}z}^{(2,1)}$  or  $\delta L_{z\bar{z}\bar{z}}^{(2,1)}$  and their complex conjugates. These are all replica symmetric. The explicit expressions are messy and unilluminating.

We thus arrive at one of our main results, which is the explicit cancellation of all the divergences in the equations of motion of Einstein-Gauss-Bonnet. Again we find that replica symmetry breaking terms can be chosen to vanish, but that this choice is not mandatory.

It is now a simple matter to extract the equation of motion for the surface:

$$\begin{aligned}
\gamma^{ij}\mathcal{K}_{ijz} &= (\tilde{\gamma}^{ij} - \lambda\delta\gamma^{ij})(\tilde{K}_{ijz} + \lambda\delta\hat{K}_{ijz}^{(1)}) \\
&= \lambda \sum_{m,\bar{m}\geq 0} \left( \delta K_z^{(m+1,\bar{m})} - \delta\gamma_{ij}^{(m,\bar{m})} \tilde{K}^{ij}_z \right) + O(\lambda^2) \\
&= 4\lambda\tilde{\mathcal{R}}^{ij}\tilde{K}_{ijz} + O(\lambda^2), \tag{3.53}
\end{aligned}$$

where we have used (3.51) to get the third line. Notice that many replica symmetry breaking terms were allowed to enter in  $\delta g^{(n)}$ , but they all canceled in the equation of motion. Also, the twist potential  $\mathcal{A}_{iz\bar{z}} = \hat{A}_{iz\bar{z}}^{(1)}$  is free, as  $\delta A_{iz\bar{z}}^{(0,0)} = -\delta A_{i\bar{z}z}^{(0,0)}$  is unconstrained. Therefore, (3.53) is the only physical constraint on  $\Sigma$ .

Comparing this result with (3.6), we see that we have reproduced the equation of motion conjectured by [117, 118], which means that  $\Sigma$  extremizes the Jacobson–Myers entropy.

## 3.5 Discussion

In this paper we explored a number of technical and conceptual generalizations of the Lewkowycz–Maldacena methodology. One key technical insight is that terms which can be gauged away at  $n = 1$  can contribute divergences to the curvature at leading order in  $(n - 1)$ . We found that these terms are harmless in general relativity but crucial for solving the field equations in Einstein–Gauss–Bonnet gravity (and presumably all higher curvature theories). We also explained how the “locally replica symmetric” boundary condition (3.21) could take the place of a global  $\mathbb{Z}_n$  replica symmetry. This conceptual generalization allowed us

to extend our ansatz to include replica symmetry breaking terms. This approach has lead us to a set of well defined calculations which allow us to derive the condition that  $\Sigma$  extremize the entropy in general relativity and Einstein–Gauss–Bonnet gravity.

Our calculations in section 3.4 complete the proof started in [108, 103, 109] that the surfaces on which one should evaluate the entropy are those extremizing the Jacobson–Myers entropy functional, at least when the Gauss–Bonnet coupling is perturbative. We expect the method to work similarly in general Lovelock gravity. Presumably the arguments can be made non-linear in the Lovelock coupling, although such extensions of general relativity seem to always suffer from pathologies, see e.g. [115].

We have also shown that there are no obvious obstructions to relaxing the assumption of replica symmetry in Lewkowycz and Maldacena’s derivation of the extremal area condition for general relativity. We have not addressed the pressing question of whether replica symmetry is actually broken, that we intend to do elsewhere. Deciding if this is the case involves finding whether replica breaking saddles dominate the path integral.

Replica symmetry breaking saddles that could dominate the holographic calculation of entanglement entropy were discussed in [122], which studied three dimensional general relativity in the context of AdS<sub>3</sub>/CFT<sub>2</sub>. The possibility of replica symmetry breaking was also discussed in [21]. Other interesting features of the Rényi entropies were considered by the authors of [123], who described non-analytic behavior of  $S_n$  away from  $n \sim 1$  by means of an instability of the hyperbolic black hole [124] of [101].



Replica symmetry breaking is used in condensed matter to describe spin glasses, which are frustrated systems (see [125] for a review). In these systems, frustration is generated by disorder originating in random impurities. It is an exciting prospect that such a dual realization of frustration may be encoded in gravity. In fact, glassy behavior has been observed in gravitational systems in [126, 127, 128, 129] and disorder has been studied in AdS/CMT in, e.g., [130, 131, 132, 133].

# Chapter 4

## A holographic proof of the averaged null energy condition

### 4.1 Introduction

It has long been known [134] that local quantum field theories allow negative energy fluctuations. The presence of negative energy is somewhat constrained in theories with a positive total energy; however positivity does not place any obvious restriction on the integrated local energy measured by a single causal observer, and therefore is insufficient to answer many interesting questions. Among these are the possible existence of warp drives, traversable wormholes, and other exotic phenomena (see e.g. [135, 136, 137, 138, 139, 140, 141]) as well as the fate of the singularity theorems of Hawking and Penrose [142, 143, 144].

To gain traction on these questions it is necessary to study operators that are better suited to capture the experience of physical observers. One such operator is

the averaged null energy, which is defined as the integral of the null-null component of the stress tensor along a null geodesic which is complete in both directions. The positivity of this quantity is called the averaged null energy condition (ANEC):

$$\int_{\gamma(\lambda)} d\lambda T_{kk} \geq 0. \quad (4.1)$$

Here  $\gamma(\lambda)$  is a complete null geodesic with affine parameter  $\lambda$  and associated tangent vector  $k$ ,  $T_{ab}$  is the stress tensor, and  $T_{kk} := \langle T_{ab} \rangle k^a k^b$ .

The ANEC was first studied in a purely classical setting by Borde [145], who showed that standard focusing theorems (see [146]) continue to hold when point-wise energy conditions (such as the null energy condition  $T_{kk} \geq 0$ ) are replaced by integrated energy conditions similar to (4.1).<sup>1</sup> Borde's theorems are sufficiently powerful to prove many other results in general relativity including a positive energy theorem [148], topological censorship [149], and the Gao-Wald theorem [91] (which we review below). Progress has also been made in proving singularity theorems with weakened energy conditions [150, 151, 152], though this program remains unfinished. Some recent reviews of energy conditions are [153, 154].

The above results establish that the ANEC is a useful restriction to place on the stress tensor. It remains to be seen if the ANEC holds for physically interesting field theories. Existing results establish that the ANEC holds in Minkowski space for free scalar fields [155, 156], Maxwell fields [157], and arbitrary two dimensional theories with positive energy and a mass gap [158]. One can also use a null surface initial data formulation to show that all free or superrenormalizable theories obey the ANEC in Minkowski space, or on bifurcate Killing horizons [159].

---

<sup>1</sup>See also the earlier work of Tipler [147] on the averaged strong and weak energy conditions.

For two dimensional curved spacetimes, one can also prove the ANEC for minimally scalar fields [160, 161, 162], at least if space is noncompact. Otherwise there is a Casimir energy which allows for ANEC violation in the vacuum, but there is still an ANEC-like bound for energy differences [156]. Many other investigations have provided additional support for the ANEC [163, 164, 165, 166], including the work of Blanco and Casini [167] which gives a simple argument showing that negative energy cannot be isolated far away from positive energy in a CFT.

For curved spacetimes with dimension greater than two it is known that the ANEC does not hold on every null curve [168, 169, 170]. However, Graham and Olum have proposed a weaker condition which they call the ‘self-consistent achronal ANEC’ [171] (see also [172]) which weakens (4.1) in two ways. First, (4.1) is only required to hold only on complete achronal geodesics, i.e. on null curves for which no two points are timelike separated. Such curves are often called ‘null lines’ in the literature. Second, the ANEC is only imposed on self-consistent spacetimes for which the gravitational field is sourced by the quantum fields, as well as any additional classical background sources.<sup>2</sup> As pointed out in [171], generic spacetimes satisfying the self-consistent achronal ANEC will not have any achronal null lines. But this fact, far from rendering the achronal ANEC trivial, has profound consequences, ruling out closed timelike curves and traversable wormholes [171, 173], and also negative energy objects [148].

But is the self-consistent achronal ANEC true? So far, Kontou and Olum have also shown that the self-consistent achronal ANEC is satisfied for a minimally coupled free scalar field on a class of curved spacetimes [174]. At first order in

---

<sup>2</sup>Without this latter restriction there are known violations of the ‘achronal ANEC’ [169, 170].

quantum corrections, it also follows if the generalized second law holds on all causal horizons [175].

## 4.2 The ANEC in holographic theories

In this paper we use the AdS/CFT correspondence [1, 2, 3] to prove the ANEC for strongly coupled conformal field theories in  $d \geq 2$  spacetime dimensions with a consistent holographic dual.<sup>3</sup> We will consider source-free CFT's in Minkowski space—where all null curves are achronal, and it is neither necessary nor possible to impose gravitational self-consistency.

Unfortunately, it is not currently possible to enumerate all field theories which satisfy the condition of having a consistent holographic dual. What is known is that AdS/CFT requires a strongly coupled field theory with a large number of species  $N$ , and several examples of the dual field theories have been worked out in great detail, most famously  $\mathcal{N} = 4$  supersymmetric Yang-Mills in four spacetime dimensions. It has also been conjectured that any strongly coupled CFT with a large- $N$  expansion and a gap in the spectrum of anomalous dimensions has an AdS dual with local dynamics [176]. We will work in the large  $N$ , strong coupling limit in which the dual theory is well approximated by general relativity. Note that this limit is distinct from taking the classical limit of the field theory.

The overall strategy of our proof is to assume our theory has nice causal properties and use these properties to derive constraints on the stress tensor. Our

---

<sup>3</sup>For  $d = 2$  the ANEC follows from an even more general argument. In 1+1 CFT's the right and left moving sectors decouple and scale invariance implies that the total energy is positive if and only if the left and right Hamiltonians are separately positive—which is equivalent to the ANEC.

approach is similar in spirit to that of Page et al. [177], who proved a positive mass theorem for asymptotically AdS spacetimes with consistent holographic duals. Their proof is similar to the proofs found in [148, 178] except that Page et al. assume their holographic theory has nice causal properties instead of assuming that the bulk spacetime satisfies an energy condition.

Several other researchers have also studied the interplay between bulk causality and various CFT bounds [179, 180, 181, 182, 183, 184, 185, 186, 187, 115]. In [179, 180], Brigante et al. studied the famous viscosity to entropy density ratio  $\eta/s$  for conformal fluids with a Gauss-Bonnet gravity dual. They were able to use causality constraints to place bounds on both the strength of the Gauss-Bonnet coupling and on the ratio  $\eta/s$ . These techniques were later generalized and applied to more general Lovelock theories by Camanho et al. in [187].

In [181], Hofman and Maldacena derived upper and lower bounds on the ratio of the central charges  $a/c$  in a four dimensional CFT. These bounds are shown to follow from positivity of the energy radiated by collider experiments as measured by distant observers [181] (which is equivalent to the ANEC [182]). Assuming that the dual bulk is described by an Einstein–Gauss–Bonnet gravity theory, the same lower bound on  $a/c$  follows [182] from the assumption that the dual gravitational Lovelock theories satisfies the causality constraint found in [179, 180]. This analysis was extended to Lovelock gravity by the authors of [183, 184, 185, 186] who also found precise matching between positive energy flux in the boundary and good causal properties in the bulk. Additionally, Hofman [182] gave a non-rigorous argument that the ANEC should hold in any UV-complete QFT, but this was subject to some unproven assumptions about nonlocal operators in the

theory. Even if there did exist a totally satisfactory field-theoretic proof of the ANEC, it would still be a nontrivial test of AdS/CFT to prove the same result using the duality.

We assume that our theory has good causality properties, in order to prove the ANEC. This gives a partial converse to [181], which assumed the ANEC in order to prove that  $a/c$  lies in the coupling window that permits good causality. In the Einstein gravity limit (which in  $d = 4$  implies  $a/c = 1$ ), our assumption of good causality is the Gao-Wald theorem, reviewed below.

It is natural to assume the gravity theory is Einstein in light of the recent result of Camanho et al. [115], who used causality to place a much tighter bound on higher derivative corrections to the bulk equations of motion. They argue that any finite deviation from Einstein gravity in the bulk at level of the three-point functions (which in  $d = 4$  is equivalent to a deviation from  $a/c = 1$ ) is inconsistent with boundary causality unless the theory contains an infinite tower of massive higher spin particles (as in string theory). For this reason we will work in the large  $N$ , strong coupling limit in which these corrections can be neglected. It would be of interest to extend our analysis to leading order in these corrections.

We now briefly review the elements of the AdS/CFT correspondence that will be used in our proof. Consider a  $d$ -dimensional conformal field theory (hereafter called the “boundary theory”) living on Minkowski space, with metric  $\eta_{ab}$ . The AdS/CFT correspondence states that this theory has a dual description in terms of a  $d + 1$  dimensional gravitational theory (the “bulk” theory) with a metric of

the form

$$ds^2 = \frac{R_{\text{AdS}}^2}{z^2} (dz^2 + g_{ab}(z, x) dx^a dx^b), \quad (4.2)$$

where  $R_{\text{AdS}}$  is the AdS length scale and  $g_{ab}(0, x) = \eta_{ab}$ . Close to the conformal boundary  $z = 0$ , the Einstein equation dictates that  $g_{ab}$  take the form

$$g_{ab}(z, x) = \eta_{ab} + z^d \gamma_{ab}(z, x), \quad \gamma_{ab}(z, x) = t_{ab}(x) + z^2 s_{ab}(z, x) \quad (4.3)$$

where  $t_{ab}$  is a traceless, conserved tensor that is otherwise unconstrained by the equations of motion and  $s_{ab}$  is regular at  $z = 0$ . The AdS/CFT dictionary [2, 3] states that the expectation value of the stress tensor of the boundary theory is given by

$$\langle T_{ab} \rangle = \frac{dR_{\text{AdS}}^{d-1}}{16\pi G} t_{ab}, \quad (4.4)$$

where  $G$  is the  $d+1$  dimensional Newton's constant. From here on we set  $R_{\text{AdS}} = 1$ ; powers of  $R_{\text{AdS}}$  can be restored by dimensional analysis. In writing down (4.3) and (4.4) we have used our restriction that all boundary sources have been turned off. In the bulk, this amounts to requiring that any bulk matter fields fall off fast enough at conformal infinity that they do not play a direct role in our analysis.

In order for the boundary theory to be local there can be no “shortcuts through the bulk” which would effectively allow signals to propagate faster than light (see Fig. 4.1(a)). This principle is encapsulated by the Gao-Wald theorem (Theorem 2 of [91]), which states that the fastest possible path between two boundary points is



a null geodesic on the boundary. The Gao-Wald theorem was proven for Einstein gravity whenever the *bulk* stress tensor  $T_{\mu\nu}^{\text{bulk}}$  satisfies the ANEC and the bulk is a generic, asymptotically locally AdS spacetime. For our purposes it is natural to take the *conclusion* of the Gao-Wald theorem to be part of the definition of a consistent holographic theory. After all, if the bulk dual permitted signaling through the bulk faster than the speed of light on the boundary, it would imply that the dual CFT permits acausal signaling (see e.g. [188]). Alternatively, we could assume that our classical bulk geometry satisfies the assumptions of the Gao-Wald and invoke the theorem.

### 4.3 Proving the holographic ANEC

Finally our proof requires two formal assumptions about  $T_{kk}$ , namely that  $|T_{kk}|$  is bounded ( $|T_{kk}| < T_{\text{max}}$ ) and that  $T_{kk}$  and its derivatives are absolutely convergent on  $\gamma(\lambda)$  (i.e. that  $\int_{\gamma} |T_{kk}|$ ,  $\int_{\gamma} |\partial T_{kk}|$ ,  $\int_{\gamma} |\partial^2 T_{kk}|, \dots$  are finite). This allows us to define the integral (4.1) as a limit of integrals over finite intervals. It is likely that these assumptions could be weakened by using the more general formulation of the ANEC in e.g. [145, 161].

We are now ready to begin our proof. Consider null coordinates on the boundary spacetime

$$\eta_{ab} dx^a dx^b = -(du dv + dv du) + d\vec{y}^2 \quad (4.5)$$

where  $d\vec{y}^2$  is the Euclidean line element over the remaining  $d-2$  spatial directions. Note that  $u$  is an affine parameter for the geodesic  $v = (\text{constant})$ ,  $\vec{y} = (\text{constant})$ .

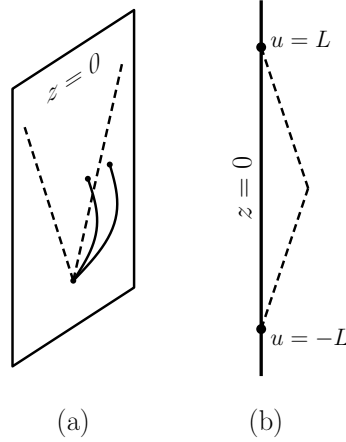

Figure 4.1: (a) Two curves which begin and end on the conformal boundary but which dip into the bulk. The assumption of good causality requires that the curve which ends outside of the boundary light cone (dashed line) cannot be causal. (b) Schematic of the construction used in our proof. The solid line is the conformal boundary  $z = 0$  and the dashed lines represent causal curves extending into the bulk. The  $v$  direction has been suppressed in this diagram.

We assume that all components of the bulk metric are smooth and bounded in these coordinates.

The strategy of our proof is to construct a causal curve which dips into the bulk, but has both endpoints anchored to the boundary. We will engineer this curve to remain close to the boundary and calculate the time delay or advance relative to a nearby boundary null geodesic (see Fig. 4.1(b)). We will find a positive “kinetic” contribution to the time delay coming from the radial motion of the curve into the bulk, and a second “potential” contribution whose sign is that of  $t_{uu}$ , and therefore may be either a delay or advance. We will carefully construct our curve so that the latter contribution dominates. Our causal assumption requires that the net time delay of the entire excursion must be positive; we will show that this restriction implies (4.1).

We parameterize our curve by the coordinate  $u$  so that  $v = V(u)$  and  $z = Z(u)$ . Without loss of generality we set  $\vec{y} = 0$ . This curve will be causal if  $V, Z$  satisfy

$$(Z')^2 - 2V' + Z^d (\gamma_{uu} + \gamma_{uv} V' + \gamma_{vv} (V')^2) \leq 0, \quad (4.6)$$

where primes indicate  $u$ -derivatives.

We now construct a curve satisfying (4.6). Consider the interval  $u \in [-L, L]$  for some  $L$  which we will ultimately take to be arbitrarily large. It is useful to introduce a small parameter  $\epsilon$ , which parameterizes how deep into the bulk our curve reaches. We need to take an  $\epsilon \rightarrow 0$  limit in order to relate our results to  $t_{uu}$  using (4.3), but in this limit any time advance due to  $t_{uu}$  is swamped by the time-delay due to veering into the bulk. Thus in order to prove an interesting result it is necessary to take a simultaneous limit in which  $L$  becomes large as  $\epsilon$  becomes small. This is why good causality implies the ANEC but not the null energy condition  $T_{uu} \geq 0$ . It turns out to be convenient to set

$$L = \epsilon^{-(d-2+2\alpha)}, \quad (4.7)$$

where  $\alpha$  is a constant satisfying  $0 < \alpha < 2/3$ . We will construct our casual curve by joining together two smooth causal curves at a sharp angle, one curve dipping into the bulk and the other coming back to the boundary (Fig. 4.1(b)),

by choosing  $V, Z$  to be given on the interval  $u \in [-L, L]$  by

$$\begin{aligned} Z(u) &= \epsilon \left( \frac{L - |u|}{L} \right) \\ V(u) &= \frac{1}{2} \left[ \frac{\epsilon^{2-\alpha}}{L} \left( \frac{L+u}{L} \right) + \epsilon^d \int_{-L}^u du' \left( \frac{L - |u'|}{L} \right)^d \gamma_{uu}(u', 0) \right], \end{aligned} \quad (4.8)$$

(In the second equation, the first term is the “kinetic” time delay and the second the “potential” delay.) The appearance of  $\alpha$  in the exponent of the first term represents an extra time delay we have inserted to ensure that (4.6) is satisfied for sufficiently small  $\epsilon$  (keeping  $\alpha$  fixed). We have used the fact that  $t_{uu}$  is smooth to power expand:

$$t_{uu}(u, V(u)) = t_{uu}(u, 0) + O(\epsilon^d), \quad (4.9)$$

since  $V(u) \sim \epsilon^d$ .<sup>4</sup>

Since the curve (4.8) is causal, our causality assumption requires that the end points of (4.8) must be causally separated in the boundary spacetime. This implies that the time delay  $\Delta V := V(L) - V(-L)$  must be positive. In terms of the stress tensor (4.4) we then find that for any  $L$

$$\int_{-L}^L d\lambda f_L T_{kk} \geq - \left( \frac{16\pi G}{dR_{\text{AdS}}^{d-1}} \right) \left( 2\epsilon^\alpha + \int_{-L}^L d\lambda \epsilon^2 |s_{kk}| \right), \quad f_L(\lambda) = \left( \frac{L - |\lambda|}{L} \right)^d, \quad (4.10)$$

where we have momentarily restored the correct powers of  $R_{\text{AdS}}$ . Note that  $0 \leq$

---

<sup>4</sup> $V(u) \sim \epsilon^d$  because the integral in (4.8) remains finite as  $L \rightarrow \infty$ . This follows from the arguments given below (4.10).

$f_L \leq 1$ . We will now show that (4.10) implies the ANEC (4.1).

First, we argue that  $\int_{-L}^L d\lambda \epsilon^2 |s_{kk}|$  vanishes in the limit  $L \rightarrow \infty$ . Expanding the Einstein equation about  $z = 0$  allows us to write  $s_{kk}$  as an algebraic (non-linear) function of  $t_{ab}$  and its derivatives.<sup>5</sup> The contribution to the integrand from quadratic and higher order terms vanish like  $\epsilon^d$  by power counting. Because we assume the metric components are bounded, the contribution to the integral from these terms must scale like  $\epsilon^d L = \epsilon^{2(1-\alpha)}$  which vanishes as we take  $L \rightarrow \infty$ . The terms in  $s_{kk}$  that are linear in  $t_{kk}$  have finite integrals by our assumption that  $T_{kk}$  and its derivatives are all absolutely convergent, therefore the contribution from these terms vanishes like  $\epsilon^2$ . Finally, terms proportional to  $\eta^{ab} t_{ab}$  vanish because  $t_{ab}$  is traceless. This accounts for all possible contributions to  $s_{kk}$ , therefore the right hand side of (4.10) vanishes as  $L \rightarrow \infty$ .

For illustrative purposes we now treat the simple case where  $T_{kk}$  is non-negative outside of some interval  $\lambda \in [-\lambda_0, \lambda_0]$ . In this case we may write

$$\int_{-L}^L d\lambda f_L T_{kk} \leq -T_{\min}^{(\lambda_0)} \left[ \int_{-\lambda_0}^{\lambda_0} d\lambda (1 - f_L) \right] + \int_{-L}^L d\lambda T_{kk}, \quad (4.11)$$

where  $T_{\min}^{(\lambda_0)}$  is a lower bound on  $T_{kk}$  in  $[-\lambda_0, \lambda_0]$ , which must exist by our assumption that  $|T_{kk}|$  is bounded. For fixed  $\lambda_0$  the term in square brackets vanishes like  $L^{-2}$  as  $L$  becomes large. Combining (4.11) and (4.10) and taking  $L \rightarrow \infty$  yields (4.1).

If the previous assumption doesn't hold then the integral in (4.1) is oscillatory

---

<sup>5</sup>See, for example, Eq. (7) in [52].

and we must be a little more careful. In this case it is useful to note that

$$\int_{-L}^L d\lambda f_L T_{kk} \leq \int_{-L}^L d\lambda (1 - f_L) |T_{kk}| + \int_{-L}^L d\lambda T_{kk}. \quad (4.12)$$

We now must show that the first term on the right hand side of (4.12) vanishes as  $L \rightarrow \infty$  and (4.1) will follow as before. In other words, we must show that for any  $\delta > 0$  there exists an  $L$  such that

$$\int_{-L}^L d\lambda (1 - f_L) |T_{kk}| < \delta. \quad (4.13)$$

By our assumption that  $T_{kk}$  is absolutely convergent, there must exist some  $\lambda_1$  such that

$$\int_{\lambda_1}^{\infty} d\lambda |T_{kk}| + \int_{-\infty}^{-\lambda_1} d\lambda |T_{kk}| < \frac{\delta}{2}. \quad (4.14)$$

Now for any  $L > \lambda_1$  we have

$$\int_{-L}^L d\lambda (1 - f_L) |T_{kk}| < T_{\max}^{(\lambda_1)} \left[ \int_{-\lambda_1}^{\lambda_1} d\lambda (1 - f_L) \right] + \frac{\delta}{2}, \quad (4.15)$$

where  $T_{\max}^{(\lambda_1)}$  is the maximum of  $|T_{kk}|$  in  $[-\lambda_1, \lambda_1]$ . As before the term in square brackets goes like  $L^{-2}$ , and therefore there always exists some  $L$  satisfying (4.13).

This completes our proof of (4.1).

## 4.4 Discussion

We have just given a simple, geometric proof of the ANEC for any field theory on Minkowski space with a consistent holographic dual. Our proof applies to strongly coupled CFT's on Minkowski space, but it would be of interest to extend our results to curved space as a test of the self-consistent achronal ANEC [171]. On a curved background Eqs. (4.3) and (4.4) contain extra terms that involve the background metric and curvature as well as any background source terms. These terms become increasingly complicated as the dimension increases and there is no known expression for arbitrary dimension. However, all of the curvature terms needed to analyze  $d \leq 6$  have been known for some time (see [45])—six dimensions being the largest dimension with a known AdS/CFT duality [1].

It would also be of interest to extend our arguments to include perturbative quantum and stringy corrections in the bulk. Because we are proving an inequality we only need to consider perturbative corrections when the classical inequality is saturated. Presumably the ANEC can only be saturated in very stringent situations, but this does not follow from our proof. It may be possible to make progress on this point by bounding the minimum time delay for a generic space-time, possibly using techniques adapted from [91, 177].

These results have the potential to lead to new insights about holography in the spirit of [177, 178, 179, 180, 181, 182, 183, 184, 185, 186, 187, 115]. There are many unanswered questions about the emergence of causal structure in AdS/CFT, so understanding the field-theoretic origin of the Gao-Wald theorem—and any perturbative higher-curvature analogues—will lead to new insights related to this emergence. It would be of interest to develop a more complete understanding of

---

how bulk causality restricts the field theory. Our analysis was restricted to causal curves which remain close to the boundary, but curves which go deeper into the bulk place restrictions on the fields in bounded regions, which are nonlinear in the boundary stress-tensor.



# Chapter 5

## Coarse-grained entropy and causal holographic information

### 5.1 Introduction

The AdS/CFT correspondence predicts that the effective degrees of freedom of certain conformal field theories (CFT's) in the large  $N$  limit are the same as the degrees of freedom of classical supergravity [1, 2, 3]. Despite many nontrivial tests of the correspondence, the precise way in which local interactions emerge in the large  $N$  limit of strongly coupled CFT's is not fully understood. What is known is that locality in the holographic dimension is intimately connected with the locality of the renormalization group (RG) flow in the CFT [189, 190, 191, 192]. From a Wilsonian point of view, this suggests that the emergence of locality in the bulk theory is related to some kind of coarse graining in the CFT.

One technical difficulty with making this idea precise is choosing an appro-

appropriate regulator to cut off the high energy modes. This problem is particularly difficult in the physically correct Lorentz signature. There the elimination of highly boosted modes normally requires sacrificing either Lorentz invariance (e.g. with a hard energy cutoff), or else positivity of the inner product (e.g. Pauli-Villars [193]). On the other hand, the bulk theory is Lorentz-invariant, and presumably has positive probabilities. Thus, although there is detailed *qualitative* agreement between the dependence of fields in the radial direction, and the RG flow of the field theory, a comprehensive framework relating the two is lacking.

Similar problems arise in the context of thermodynamics. In order to obtain a nontrivial second law of thermodynamics, one needs to define a coarse-grained entropy. As with the renormalization group flow, there are multiple possible coarse graining procedures. Which one you choose affects the exact results for quantities like the entropy, introducing an element of subjectivity. One hopes that in the thermodynamic limit, the choice does not matter at leading order. But gauge/gravity duality suggests that (at least in the large  $N$  limit) there may be a particular coarse graining procedure which has especially nice properties, due to its relation to bulk locality.

In this chapter we will explore the relation between coarse graining of the CFT and bulk locality. Rather than focusing on the RG flow, we will study the localization of information in the CFT by attempting to relate coarse-grained entropies in regions of the CFT to areas of bulk surfaces.

We take inspiration from the Ryu-Takayanagi conjecture (and its later generalization by Hubeny, Rangamani, and Takayanagi) which relates the *fine-grained* von Neumann entropy of a piece of the boundary to the area of minimal or ex-

tremal/maximin surfaces in the bulk known as the holographic entanglement entropy [19, 20, 194, 195]. This conjecture has been validated in every case in which we have control over the calculations on both sides of the duality and significant progress has been made towards a proof [100, 196, 101, 21, 197, 122]. Work has even begun on explicit constructions of the bulk geometry from the holographic entanglement entropy of arbitrary boundary regions [198, 199, 200, 201, 22, 202]. Here we will propose a similar conjecture, but using a *coarse-grained* entropy of a boundary region, in place of the von Neumann entropy.

More recently Hubeny and Rangamani proposed a new quantity  $\chi_{\mathcal{A}}$  which they called the “causal holographic information” [25, 203, 204]. This quantity is equal to the area of a co-dimension two surface in the bulk that is defined by its casual relation to a boundary region  $\mathcal{A}$ . For a host of reasons Hubeny and Rangamani conjectured that  $\chi$  quantifies some aspect of the information content of the associated boundary domain of dependence.<sup>1</sup> We will present evidence that, for source-free boundary theories,  $\chi$  is dual to a particular coarse-grained entropy  $\mathcal{S}^{(1)}$ . We will refer to  $\mathcal{S}^{(1)}$  as the ‘one-point entropy’, because it depends only on the one-point functions of local operators in the domain of dependence of  $\mathcal{A}$ .

We also propose a second duality between a coarse graining  $\mathcal{S}^{(\wedge)}$  (the ‘future one-point entropy’) and a bulk quantity  $\phi$  (the ‘future causal information’). These quantities are natural generalizations of  $\mathcal{S}^{(1)}$  and  $\chi$ , but have the appealing new property that they can increase during processes which involve thermalization in the CFT (corresponding to horizon formation in the bulk). If this new conjecture is correct, the thermodynamic second law obeyed by  $\mathcal{S}^{(\wedge)}$  is dual to the area theorem

---

<sup>1</sup>See also [205, 206] for other approaches to understanding the information contained in boundary regions.

in general relativity [207], as applied to causal horizons of the form  $\partial J^-(\mathcal{Z})$  where  $\mathcal{Z}$  is some set of points on the boundary of AdS and  $\partial J^-$  is the boundary of the causal past.<sup>2</sup> In this way we propose a precise connection between Hawking’s area theorem and the thermalization of a quantum mechanical system.

In section 5.2 we briefly review the definition of the causal holographic information and establish our notation. In section 5.3 we define a class of coarse-grained entropies and explore their general properties. In section 5.4 we define the one-point entropy  $\mathcal{S}^{(1)}$  and present evidence for the conjecture that  $\mathcal{S}^{(1)} = \chi$  (for source-free boundary theories). We also comment on the uniqueness of our proposal and the prospects for precision tests. In section 5.5 we define the future causal information  $\phi$  and the future one-point entropy  $\mathcal{S}^{(\wedge)}$  and present evidence that they are also dual to each other (for source-free boundary theories). Finally, in section 5.6 we conclude by summarizing our results and commenting on the prospects of extending our conjectures to the semiclassical regime.

Appendix A.1 presents two illustrative examples of failed proposals for the dual of  $\chi$ , and appendix A.2 constructs a counterexamples to our conjecture, in the case where boundary sources are allowed.

Whenever possible we adopt the notation of [25] (see section 5.2 for a review) with the exception that we use  $D^\pm[\mathcal{A}]$ ,  $J^\pm[\mathcal{A}]$  to refer to the boundary future (past) domain of dependence and domain of influence and  $D_{\text{bulk}}^\pm[\mathcal{A}]$ ,  $J_{\text{bulk}}^\pm[\mathcal{A}]$  to refer to the associated bulk regions.

---

<sup>2</sup>This generalizes the notion of ‘causal horizon’ defined by Jacobson and Parentani [208], whose definition would require  $\mathcal{Z}$  to be just one point.

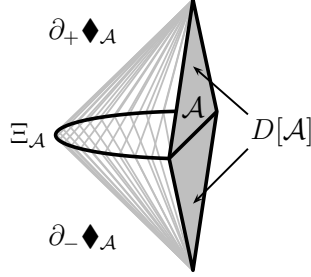

Figure 5.1: A sketch of the causal wedge construction of [25].  $D[\mathcal{A}]$  is the boundary domain of dependence of  $\mathcal{A}$  and  $\Xi_{\mathcal{A}}$  extends into the bulk (see text).

## 5.2 Causal holographic information: A brief review

In this section we briefly review the definition of causal holographic information  $\chi$ . See [25, 203, 204] for additional details. We emphasize that for our purposes,  $\chi$  is only well-defined on classical geometries (i.e. in the strict  $N \rightarrow \infty$  limit).

Consider a closed spatial region  $\mathcal{A}$  on the boundary CFT of an asymptotically AdS spacetime.<sup>3</sup> We assume that  $\mathcal{A}$  is achronal (i.e. no timelike curves pass through it more than once), and codimension-one on the boundary. The region  $\mathcal{A}$  defines a causal domain of dependence  $D[\mathcal{A}] = D^+[\mathcal{A}] \cup D^-[\mathcal{A}]$ , where  $D^\pm[\mathcal{A}]$  is defined as the collections of points  $p$  for which any infinitely extended timelike curve must intersect  $\mathcal{A}$  to the past (future) of  $p$  [209].

The boundary domain of dependence  $D[\mathcal{A}]$  defines a bulk causal wedge:

$$\diamond_{\mathcal{A}} = J_{\text{bulk}}^+[D[\mathcal{A}]] \cap J_{\text{bulk}}^-[D[\mathcal{A}]], \quad (5.1)$$

<sup>3</sup>Since we are restricting to source-free boundaries, we only consider the case in which the boundary is conformally flat. But perhaps it is possible to generalize to static boundary geometries.

where  $J_{\text{bulk}}^{\pm}[\mathcal{A}]$  is the future (past) of  $D[\mathcal{A}]$  in the bulk. In other words any point  $p$  in  $\diamond_{\mathcal{A}}$  lies on at least one causal curve that begins and ends in  $D[\mathcal{A}]$  (see Fig. 5.1).

Even though the topology of  $\diamond_{\mathcal{A}}$  may be nontrivial [204], the boundary of  $\diamond_{\mathcal{A}}$  can be written as

$$\partial \diamond_{\mathcal{A}} = \partial_+ \diamond_{\mathcal{A}} \cup \partial_- \diamond_{\mathcal{A}}, \quad (5.2)$$

where  $\partial_{\pm} \diamond_{\mathcal{A}}$  are future (past) horizons anchored to the future (past) boundary of  $D[\mathcal{A}]$ . These null surfaces intersect in a co-dimension two surface

$$\Xi_{\mathcal{A}} = \partial_+ \diamond_{\mathcal{A}} \cap \partial_- \diamond_{\mathcal{A}}, \quad (5.3)$$

known as the ‘causal information surface’ from which we calculate the causal holographic information:

$$\chi_{\mathcal{A}} = \frac{\text{Area}[\Xi_{\mathcal{A}}]}{4G_N}, \quad (5.4)$$

where  $G_N$  is Newton’s constant.

Equation (5.4) is reminiscent of the definition of the HEE:

$$S_{\mathcal{A}} = \frac{\text{Area}[\mathfrak{E}_{\mathcal{A}}]}{4G_N}, \quad (5.5)$$

where  $\mathfrak{E}_{\mathcal{A}}$  is defined as the minimum area extremal surface homologous to  $\mathcal{A}$  [194] or equivalently as the maximin surface as described in [195]. We mention here, since it will come up many times in our later analysis, that it has been shown

in [25, 195] that

$$S_{\mathcal{A}} \leq \chi_{\mathcal{A}} \tag{5.6}$$

for smooth spacetimes satisfying the null energy condition which we will assume throughout, since we are concerned with supergravity theories arising in AdS/CFT, for which the null energy condition holds classically.

Throughout this paper we will assume that the Ryu-Takayanagi conjecture is true. More precisely we assume that the order  $N^2$  contribution to the von Neumann entropy of the reduced density matrix on  $\rho_{\mathcal{A}}$  is equal to  $S_{\mathcal{A}}$ .<sup>4</sup> Since we will only ever be interested in the  $N \rightarrow \infty$  limit (see section 5.3.2 below) we will avoid introducing a new symbol and simply let

$$S_{\mathcal{A}}(\rho_{\mathcal{A}}) = -\text{Tr}[\rho_{\mathcal{A}} \log(\rho_{\mathcal{A}})]. \tag{5.7}$$

Note that the entanglement entropy is divergent, as is the area of  $\mathfrak{E}_{\mathcal{A}}$ . In principle, one should figure out what is the precise numerical relationship between the two cutoffs, in order to compare the bulk and boundary quantities using the UV/IR correspondence [218]. Since this is difficult, it is more usual to cut off both quantities independently, and then to compare only quantities which are independent of the cutoff procedure [19, 101]. This includes logarithmic divergences and certain finite terms. Note also that the divergences are state independent (at least for regular states), so universal information can also be extracted by comparing

---

<sup>4</sup>Here we gloss over subtle questions involving how to define local observables in a gauge theory, and whether there are additional “contact terms” besides the entanglement entropy which should be included in the definition of  $S_{\mathcal{A}}$  [210, 211, 212, 213, 214, 215, 216, 217].

states.

Presumably, a similar procedure should be used for  $\chi_{\mathcal{A}}$  and  $\mathcal{S}_{\mathcal{A}}^{(1)}$ . However, unlike  $\mathfrak{E}_{\mathcal{A}}$ , the divergences in the area of  $\Xi_{\mathcal{A}}$  depend on the choice of  $\mathcal{A}$  in a nonlocal way [219]. We will comment briefly in section 5.4.4 on the plausibility of  $\mathcal{S}_{\mathcal{A}}^{(1)}$  and  $\chi_{\mathcal{A}}$  having matching divergences. Note that because  $\chi$  and  $S$  differ in their divergences, inequalities such as  $S_{\mathcal{A}} \leq \chi_{\mathcal{A}}$  typically reduce to a statement comparing the coefficients of their leading-order divergences.<sup>5</sup>

## 5.3 Coarse-grained entropies

### 5.3.1 Definition

For the purposes of this paper a coarse-grained entropy is calculated by maximizing the von Neumann entropy subject to some set of constraints. More precisely, we define a coarse-grained entropy  $\mathcal{S}_{\mathcal{A}}$  associated with boundary region  $\mathcal{A}$  to be (cf. [220])

$$\mathcal{S}_{\mathcal{A}}(\rho_{\mathcal{A}}) = \sup_{\tau_{\mathcal{A}} \in T_{\mathcal{A}}} [S_{\mathcal{A}}(\tau_{\mathcal{A}})] \quad (5.8)$$

where  $\rho_{\mathcal{A}}$  is the reduced density matrix associated with  $\mathcal{A}$ ,  $S_{\mathcal{A}}(\tau_{\mathcal{A}})$  is the von Neumann entropy of  $\tau_{\mathcal{A}}$ , and  $T_{\mathcal{A}}(\rho_{\mathcal{A}})$  is the set of all density matrices  $\tau_{\mathcal{A}}$  which

---

<sup>5</sup>This requires that the quantities be regulated in a manner consistent with the proof; for example theorem 14 of [195] compares the surfaces  $\Xi$  and  $\mathfrak{E}$  using the second law, so the two surfaces must be regulated in such a way that the second law can be used.



satisfy the constraints

$$\mathrm{Tr}[\mathcal{O}_m \tau_{\mathcal{A}}] = \mathrm{Tr}[\mathcal{O}_m \rho_{\mathcal{A}}] \quad (5.9)$$

where the  $\{\mathcal{O}_m\}$  are a set of operators supported in  $D[\mathcal{A}]$ . Different coarse-grained entropies differ only in the choice of constraints.

We will call the density matrix  $\sigma_{\mathcal{A}} \in T_{\mathcal{A}}$  that maximizes the von Neumann entropy the “coarse graining” of  $\rho_{\mathcal{A}}$ , so that

$$\mathfrak{S}_{\mathcal{A}}(\rho_{\mathcal{A}}) = S_{\mathcal{A}}(\sigma_{\mathcal{A}}). \quad (5.10)$$

This coarse-grained state must be unique, since if we had two candidate states with equal entropy  $\sigma_{\mathcal{A}}^{(1)}$  and  $\sigma_{\mathcal{A}}^{(2)}$ , then by convexity of the von Neumann entropy we could construct a higher entropy state  $\sigma_{\mathcal{A}} = (\sigma_{\mathcal{A}}^{(1)} + \sigma_{\mathcal{A}}^{(2)})/2$ . According to [220] the general solution to (5.8) is (even when the  $\mathcal{O}_m$  are not mutually commuting)

$$\sigma_{\mathcal{A}} = Z^{-1} \exp\left(-\sum_m \lambda_m \mathcal{O}_m\right), \quad (5.11)$$

where  $\lambda_m$  are Lagrange multipliers determined by solving (5.9) and the normalization constant  $Z$  is the partition function. In other words  $\sigma_{\mathcal{A}}$  is a sort of generalized ensemble in which the  $\lambda_m$  play the role of chemical potentials.

It will be useful in the following discussion to characterize coarse grainings by their relative strengths as follows. Consider two entropies  $\tilde{\mathfrak{S}}$  and  $\bar{\mathfrak{S}}$  as defined above with different sets of constraints. If the constraints of  $\tilde{\mathfrak{S}}$  are a proper subset of the constraints of  $\bar{\mathfrak{S}}$  (so that  $\tilde{T} \subset \bar{T}$ ) then we say that  $\tilde{\mathfrak{S}}$  is a stronger coarse

graining than  $\bar{\mathcal{S}}$  and we use the notation  $\bar{\mathcal{S}} \prec \tilde{\mathcal{S}}$ .<sup>6</sup> This implies that

$$\bar{\mathcal{S}}_{\mathcal{A}}(\rho_{\mathcal{A}}) \leq \tilde{\mathcal{S}}_{\mathcal{A}}(\rho_{\mathcal{A}}), \quad (5.12)$$

for all states  $\rho_{\mathcal{A}}$ , where equality holds if and only if  $\tilde{\sigma}_{\mathcal{A}} \in \bar{T}(\rho_{\mathcal{A}})$ . Finally, if for two coarse grainings  $\hat{\mathcal{S}}$  and  $\bar{\mathcal{S}}$  neither set of constraints is a subset of the other, then we say that  $\hat{\mathcal{S}}$  and  $\bar{\mathcal{S}}$  are incomparable and we use the notation  $\hat{\mathcal{S}} \parallel \bar{\mathcal{S}}$ .

For future reference we prove a mathematical result that holds for all  $\mathcal{S}$ :

(L1) For any positive definite, Hermitian density matrix we may, without loss of generality, write

$$\rho_{\mathcal{A}} = Z^{-1} \exp(-\beta H). \quad (5.13)$$

The operator  $H$  is known as the modular Hamiltonian associated with  $\rho_{\mathcal{A}}$  and is generally non-local except in a few special cases,  $\beta$  is a number, and  $Z = \text{Tr}[\exp(-\beta H)]$ . If  $H$  is one of the constraint operators associated with  $\mathcal{S}$ , (i.e.  $H \in \{\mathcal{O}_m\}$ ) then

$$\mathcal{S}_{\mathcal{A}}(\rho_{\mathcal{A}}) = S_{\mathcal{A}}(\rho_{\mathcal{A}}). \quad (5.14)$$

The proof is as follows: The state  $\rho_{\mathcal{A}}$  maximizes the entropy subject to a subset of the constraints (namely the constraint associated with  $\langle H \rangle$ ), but

---

<sup>6</sup>Note that when the constraints are weaker, the coarse graining is “stronger”, in that one is forgetting more about the state. The weakest possible coarse graining is simply the fine-grained entropy  $S$ , which involves constraining all information about the state.

adding additional constraints can only lower the entropy, therefore

$$\mathcal{S}_{\mathcal{A}}(\rho_{\mathcal{A}}) \leq S_{\mathcal{A}}(\rho_{\mathcal{A}}). \quad (5.15)$$

However,  $\rho_{\mathcal{A}}$  satisfies all of the constraints (5.9); therefore by virtue of the maximization condition in (5.8) we also have

$$\mathcal{S}_{\mathcal{A}}(\rho_{\mathcal{A}}) \geq S_{\mathcal{A}}(\rho_{\mathcal{A}}), \quad (5.16)$$

and thus we obtain (5.14).

### 5.3.2 A correspondence principle

Whereas the coarse-grained entropies  $\mathcal{S}$  are defined for all reduced density matrices  $\rho_{\mathcal{A}}$ ,  $\chi$  is defined only on classical spacetimes. This means that any correspondence between some  $\mathcal{S}$  and  $\chi$  must be restricted to the large  $N$  limit of the dual field theory. More precisely we define the correspondence limit of a coarse-grained entropy by calculating  $\mathcal{S}$  at finite  $N$  and retaining only the order  $N^2$  term as we formally take the  $N \rightarrow \infty$  limit. We will work in the general relativity limit, in which the bulk Newton's constant  $G_N$  remains finite as the string and Planck lengths vanish. Of course, it would be of interest to extend the definition of  $\chi$  into the semiclassical regime perhaps using the generalized entropy [95, 97] as inspiration (see [221] for an extensive review) and compare subleading corrections; however we will not pursue that idea in this work except for brief comments in section 5.6.

Of course not every density matrix is dual to a classical geometry in the bulk.

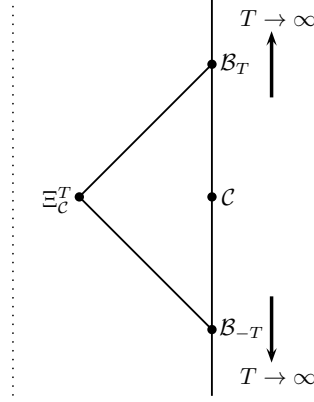

Figure 5.2: When  $\mathcal{C}$  is a Cauchy surface  $\chi_{\mathcal{C}}$  is calculated from the area of  $\Xi_{\mathcal{C}}^T$ .  $\mathcal{B}_{\pm T}$  are slices of a foliation of boundary Cauchy surfaces and  $\Xi_{\mathcal{C}}^T$  is the intersection of their respective past and future horizons. This construction addresses non-perturbative late time quantum effects such to Poincaré recurrences and black hole evaporation.

We will therefore be particularly interested in density matrices which define a bulk causal wedge  $\blacklozenge_{\mathcal{A}}$  in the dual description. We will call any such density matrix a “classical state.” Note that if  $\rho_{\mathcal{A}}$  is classical it is not clear that the coarse-grained state  $\sigma_{\mathcal{A}}$  must also be classical.

A subtlety arises when  $\mathcal{C}$  is a Cauchy surface of the boundary, i.e. when  $D[\mathcal{C}]$  is the entire boundary. In this case, the field theory states will experience Poincaré recurrences and other large fluctuations over times of order  $\exp(N^2)$ . These fluctuations and recurrences allow thermal states to be reconstructed simply by waiting an extremely long time. It is therefore appropriate that in the correspondence limit we monitor the constraints (5.9) only over times that are parametrically larger than any scale in the classical spacetime, while still being parametrically smaller than  $\exp(N^2)$ .

More precisely we define  $\mathcal{S}_{\mathcal{C}}$  by introducing a foliation of Cauchy surfaces  $\mathcal{B}_t$

and replacing  $D[\mathcal{C}]$  with region bounded by  $\mathcal{B}_{-T}$  and  $\mathcal{B}_T$ . We then take  $T \rightarrow \infty$  as  $N \rightarrow \infty$  while maintaining  $T \ll \exp(N^2)$ .<sup>7</sup> On the bulk side we use the same foliation  $\mathcal{B}_t$  of the boundary to define the family of surfaces (see Fig. 5.2)

$$\Xi_{\mathcal{C}}^T = \partial_+(J_{\text{bulk}}^-[\mathcal{B}_T]) \cap \partial_-(J_{\text{bulk}}^+[\mathcal{B}_{-T}]), \quad (5.17)$$

and we define the causal holographic information of the Cauchy surface  $\mathcal{C}$  as

$$\chi_{\mathcal{C}} = \lim_{T \rightarrow \infty} \frac{\text{Area}[\Xi_{\mathcal{C}}^T]}{4G_N}. \quad (5.18)$$

One consequence of taking the correspondence limit is that it is possible for coarse grainings which are different at finite  $N$  to agree to order  $N^2$  for all classical states as we take  $N \rightarrow \infty$ . We will say that any two such coarse grainings are “equivalent” and we will use the symbol  $\bar{\mathcal{S}} \equiv \tilde{\mathcal{S}}$ .<sup>8</sup> We will often only be interested in classifying coarse-grained entropies as stronger or weaker up to this equivalence relation.

<sup>7</sup>or using the much shorter black hole evaporation time for spacetimes with sufficiently small black holes.

<sup>8</sup>This fact suggests a more general class of coarse grainings. One could replace the constraint (5.9) with

$$|\text{Tr}[\mathcal{O}_m \tau_{\mathcal{A}}] - \text{Tr}[\mathcal{O}_m \rho_{\mathcal{A}}]| < c_m N^{1-k_m}, \quad (5.19)$$

where  $c_m, k_m$  are positive constants. It is then possible that these generalized coarse grainings would agree with our coarse grainings  $\mathcal{S}$  in the correspondence limit, but differ for finite  $N$ . Coarse grainings of this type could play an important role in future investigations of the semiclassical regime. For now, however, we will only use constraints of the form (5.9) because we are uncertain how to choose  $c_m$  and  $k_m$ . We thank Don Marolf for pointing this out.

### 5.3.3 General properties

We now list a few general properties that hold for all coarse-grained entropies  $\mathcal{S}$ .

(A1) **The coarse-grained entropy of  $\mathcal{A}$  depends only on the domain of dependence  $D[\mathcal{A}]$ :** In particular, if there are two regions  $\mathcal{A}$  and  $\mathcal{B}$  for which  $D[\mathcal{A}] = D[\mathcal{B}]$  then  $\rho_{\mathcal{A}} = \rho_{\mathcal{B}}$  and  $\mathcal{S}_{\mathcal{A}}(\rho_{\mathcal{A}}) = \mathcal{S}_{\mathcal{B}}(\rho_{\mathcal{B}})$ . This property follows trivially from the definition of  $\mathcal{S}_{\mathcal{A}}(\rho_{\mathcal{A}})$  and unitarity. The analogous result  $\chi_{\mathcal{A}} = \chi_{\mathcal{B}}$  also follows trivially from the definition of  $\chi$ .

(A2) **Coarse graining can only increase the von Neumann entropy:** By virtue of the maximization condition in our definition of  $\mathcal{S}_{\mathcal{A}}$

$$\mathcal{S}_{\mathcal{A}}(\rho_{\mathcal{A}}) \geq S_{\mathcal{A}}(\rho_{\mathcal{A}}). \quad (5.20)$$

This property echoes the result of [25, 195] that  $\chi_{\mathcal{A}} \geq S_{\mathcal{A}}$ .

(A3) **The coarse-grained entropy is the entropy of the coarse-grained state:** Given some state  $\rho_{\mathcal{A}}$ , if  $\tau_{\mathcal{A}}$  is any state which satisfies the constraints (5.9) (i.e.  $\tau_{\mathcal{A}} \in T_{\mathcal{A}}(\rho_{\mathcal{A}})$ ) and  $\sigma_{\mathcal{A}}$  is the coarse graining of  $\rho_{\mathcal{A}}$  then

$$\mathcal{S}_{\mathcal{A}}(\rho_{\mathcal{A}}) = \mathcal{S}_{\mathcal{A}}(\tau_{\mathcal{A}}) = \mathcal{S}_{\mathcal{A}}(\sigma_{\mathcal{A}}) = S_{\mathcal{A}}(\sigma_{\mathcal{A}}). \quad (5.21)$$

From these simple facts we learn two things. First, if a coarse-grained entropy  $\mathcal{S}$  is dual to  $\chi$  then it must have the property that for any classical state  $\rho_{\mathcal{A}}$

$$\chi_{\mathcal{A}}(\rho_{\mathcal{A}}) = \chi_{\mathcal{A}}(\tau_{\mathcal{A}}), \quad (5.22)$$

where  $\tau_{\mathcal{A}}$  is any other classical state in  $T_{\mathcal{A}}(\rho_{\mathcal{A}})$ . We call any coarse graining which satisfies (5.22) a ‘ $\chi$ -preserving coarse graining.’ Second, if  $\mathcal{S}$  is a  $\chi$ -preserving coarse-graining and  $\rho_{\mathcal{A}}$  is a classical state for which the coarse-grained state  $\sigma_{\mathcal{A}}$  is also classical then

$$\mathcal{S}_{\mathcal{A}}(\rho_{\mathcal{A}}) \leq \chi_{\mathcal{A}}(\rho_{\mathcal{A}}). \quad (5.23)$$

The conjunction of these results gives an even more useful result. Let  $\bar{\mathcal{S}}$  and  $\tilde{\mathcal{S}}$  be two  $\chi$ -preserving coarse grainings and let  $\bar{\mathcal{S}} \prec \tilde{\mathcal{S}}$ . Now let  $\tilde{R}$  be the set of classical states which are mapped to classical coarse-grained states under the coarse graining  $\tilde{\mathcal{S}}$ . We say that  $\tilde{\mathcal{S}}$  is a ‘classical coarse graining’ on  $\tilde{R}$  and it follows that for any  $\rho_{\mathcal{A}} \in \tilde{R}$

$$\bar{\mathcal{S}}_{\mathcal{A}}(\rho_{\mathcal{A}}) \leq \tilde{\mathcal{S}}_{\mathcal{A}}(\rho_{\mathcal{A}}) \leq \chi_{\mathcal{A}}(\rho_{\mathcal{A}}). \quad (5.24)$$

This implies that  $\bar{\mathcal{S}}$  cannot be dual to  $\chi$  unless  $\bar{\mathcal{S}}(\rho_{\mathcal{A}}) = \tilde{\mathcal{S}}(\rho_{\mathcal{A}})$  for all  $\rho_{\mathcal{A}} \in \tilde{R}$ . In other words, if  $\tilde{\mathcal{S}}$  is dual to  $\chi$  it must be (at order  $N^2$ ) as strong as possible over the states  $\tilde{R}$ . This would imply that, up to equivalence,  $\tilde{\mathcal{S}}$  would have to be the unique maximally-strong coarse graining over  $\tilde{R}$ , among those which are  $\chi$ -preserving and classical.

The restriction that  $\tilde{\mathcal{S}}$  be as strong as possible only over the states  $\tilde{R}$  is a little unwieldy since the definition of  $\tilde{R}$  depends on  $\tilde{\mathcal{S}}$ . So, it is natural to ask if the restriction to  $\tilde{R}$  can simply be dropped, meaning that we would look for the strongest possible  $\chi$ -preserving coarse graining. The answer is no, as we show in Appendix A.1. Given the importance of this restriction, it is interesting to consider  $\chi$ -preserving coarse grainings which map *all* classical states to classical coarse-grained states. (An example of such a coarse graining is the fine grained entropy  $S$  which preserves the entire state.) These completely classical coarse-grained entropies are particularly convenient to work with because in principle all of their properties can be derived by studying boundary value problems in classical general relativity. While it is still logically consistent that  $\chi$  is dual to a non-classical coarse graining, our intuition is that  $\chi$  is dual to the strongest  $\chi$ -preserving coarse-grained entropy which always maps classical states to classical coarse-grained states.

In section 5.4 we will define the one-point entropy  $\mathcal{S}^{(1)}$  and argue that it is the strongest, classical  $\chi$ -preserving coarse graining, at least in a particular perturbative context.

## 5.4 The one-point entropy

In this section we define a particular coarse-grained entropy which we call the ‘one-point entropy’  $\mathcal{S}^{(1)}$ , and present evidence that it is dual to  $\chi$  for theories without boundary sources (see appendix A.2). We will then compare the one-point entropy to other coarse-grained entropies, and indicate some potential future tests



of our conjecture.

### 5.4.1 Definition of the one-point entropy

The constraints  $\{\mathcal{O}_m\}$  of  $\mathcal{S}_{\mathcal{A}}^{(1)}$  are the one-point functions of all gauge-invariant, local CFT operators supported on  $D[\mathcal{A}]$ .

Since we will only be testing our conjecture  $\mathcal{S}^{(1)} = \chi$  in the classical correspondence limit, many of the one-point CFT operators in  $\{\mathcal{O}_m\}$  do not play much of a role. This includes:

- Fermionic operators, because fermions anticommute and therefore it is difficult to make sense of them in the classical limit;
- Multi-trace operators, because the asymptotic boundary values of the classical fields can be determined from the single-trace operators alone;
- Operators whose dimension is parametrically large in  $N$ , because these correspond to very massive objects in the bulk, which are not contained in the classical supergravity field theory limit.

It is not clear to us whether operators like these should be included or excluded. Possibly it makes no difference at order  $N^2$ , in which case either choice would lead to equivalent coarse grainings.<sup>9</sup> For the sake of definiteness, we define  $\mathcal{S}^{(1)}$  to include constraints from *all* one-point functions. However, the reader should bear in mind the other possibilities.

---

<sup>9</sup>But one would have to make a definite choice if one tried to extend the conjecture to the semiclassical regime, as discussed in section 5.6.

The AdS/CFT dictionary states that the single-trace one-point functions are given by

$$\langle \mathcal{O}_m(x) \rangle = \frac{s}{\sqrt{-g}} \frac{\delta S_{\text{ren}}}{\delta \tilde{\varphi}(x)}, \quad (5.25)$$

where  $g$  is the determinant of the boundary metric  $g_{\mu\nu}$ ,  $\tilde{\varphi}$  is an appropriately conformally rescaled bulk field,  $s$  is a conventional constant, and  $S_{\text{ren}}$  is the renormalized action which includes the boundary counterterms required by the prescription of [52, 53] (see [44] for a review). For example, the one-point functions of the stress tensor are given by

$$\langle T^{\mu\nu}(x) \rangle = \frac{2}{\sqrt{-g}} \frac{\delta S_{\text{ren}}}{\delta g_{\mu\nu}(x)}, \quad (5.26)$$

with similar relations holding for all of the other bulk fields. These relations allow us to express the constraints as a set of conditions on the asymptotic behavior of the bulk fields in  $\diamond_{\mathcal{A}}$ .

### 5.4.2 Properties of the one-point entropy

We now list some properties of the one-point entropy  $\mathcal{S}^{(1)}$  (beyond those in section 5.3.3 which apply to all coarse grainings) that make it a promising candidate for the dual of  $\chi$ .

**(B1) The one-point entropy is additive for spacelike separated regions:**

Consider two spacelike separated boundary regions  $\mathcal{A}$  and  $\mathcal{B}$  for which  $D[\mathcal{A}] \cap D[\mathcal{B}] = \emptyset$ . (Note that because these domains are closed,  $D[\mathcal{A}]$  and

$D[\mathcal{B}]$  cannot even touch at their boundaries.) Consider the state  $\rho_{\mathcal{A}} \otimes \rho_{\mathcal{B}}$ . This state is not in general the same state as  $\rho_{\mathcal{A}\cup\mathcal{B}}$ , because the correlations between  $\mathcal{A}$  and  $\mathcal{B}$  have been removed. However, since the constraints (5.9) only involve local operators, correlations between the two regions will not contribute to any of the expectation values of local operators, so the constraints factorize. Thus,  $\sigma_{\mathcal{A}\cup\mathcal{B}} = \sigma_{\mathcal{A}} \otimes \sigma_{\mathcal{B}}$  and we obtain

$$\mathcal{S}_{\mathcal{A}\cup\mathcal{B}}^{(1)} = \mathcal{S}_{\mathcal{A}}^{(1)} + \mathcal{S}_{\mathcal{B}}^{(1)}. \quad (5.27)$$

Now by boundary causality on the CFT, we know that there are no timelike or null causal curve connecting  $D[\mathcal{A}]$  and  $D[\mathcal{B}]$  in the bulk. Hence the bulk causal wedges do not “interact” and the causal holographic information obeys

$$\chi_{\mathcal{A}\cup\mathcal{B}} = \chi_{\mathcal{A}} + \chi_{\mathcal{B}}. \quad (5.28)$$

A similar observation for a related proposal was previously made in [219] (see section 5.6 for further discussion).

This is a special property of the one-point entropy. A coarse-graining  $\mathcal{S}^{(n)}$  which included the effects of higher n-point functions would not in general be additive, since it would be sensitive to correlations between two nearby regions  $\mathcal{A}$  and  $\mathcal{B}$ .

**(B2) The one-point entropy of a pure state does not always vanish:**

Consider a thermal state  $\rho_{\text{thermal}}$  with finite temperature  $\beta > 0$ . A pure

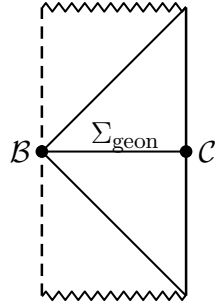

Figure 5.3: A causal diagram of the geon spacetime described in the text.  $\Sigma_{\text{geon}}$  is a bulk Cauchy surface,  $\mathcal{C}$  is a boundary Cauchy surface and  $\mathcal{B}$  is the bifurcation surface of the geon.

state  $|\psi\rangle$  for which

$$\langle \mathcal{O}_m \rangle_{|\psi\rangle\langle\psi|} = \langle \mathcal{O}_m \rangle_{\rho_{\text{thermal}}}, \quad (5.29)$$

will have the property that for any Cauchy surface  $\mathcal{C}$  we have  $\mathcal{S}_{\mathcal{C}}^{(1)}(|\psi\rangle\langle\psi|) > 0$ . Note that we must use the limiting procedure described in section 5.3.2 to exclude Poincaré recurrences or other large quantum fluctuations from our analysis.

An interesting example of such states are topological geons [222]. The simplest geon solution is constructed by cutting off a  $t = 0$  slice of AdS-Schwarzschild at the bifurcation surface  $\mathcal{B}$  and then identifying antipodal points on  $\mathcal{B}$  to heal the geometry. Call the resulting surface  $\Sigma_{\text{geon}}$ . The maximal evolution of  $\Sigma_{\text{geon}}$  is a spacetime that has AdS-Schwarzschild as its universal covering space (see Fig. 5.3). In  $D = 4$  spacetime dimensions this geometry is called a  $\mathbb{RP}_3$  geon because its spatial slices have topology  $\mathbb{RP}_3 - \{O\}$  where  $O$  corresponds to spatial infinity (see e.g. [149]).

Now we will show that the CFT state  $\rho_{\text{geon}}$  associated with this geometry is a pure state by calculating  $S_{\mathcal{C}}(\rho_{\text{geon}})$ , where  $\mathcal{C}$  is a Cauchy surface of geon boundary. The HRT proposal tells us that we must find the minimum-area extremal surface  $\mathfrak{E}_{\mathcal{C}}$  that is homologous to  $\mathcal{C}$ . As with AdS-Schwarzschild there are two candidate extremal surfaces: the empty set (with zero area) and the bifurcation surface (with finite area). In AdS-Schwarzschild only the bifurcation surface is homologous to  $\mathcal{C}$ ; therefore  $S_{\mathcal{C}}(\rho_{\text{thermal}}) = S_{BH}$  (where  $\rho_{\text{thermal}}$  is the dual CFT state and  $S_{BH}$  is the Bekenstein-Hawking entropy). But in the geon spacetime, the empty set is also homologous to  $\mathcal{C}$ ; therefore  $S_{\mathcal{C}}(\rho_{\text{geon}}) = 0$  (see also [223]).

Next we calculate  $\mathcal{S}_{\mathcal{C}}^{(1)}(\rho_{\text{geon}})$ . By construction the geon spacetime is isometric to AdS-Schwarzschild in the exterior of the horizon. It then follows trivially from the AdS/CFT dictionary (5.26) that the one-point functions of  $\rho_{\text{geon}}$  and  $\rho_{\text{thermal}}$  are equal. Therefore, by (A3) we have

$$\mathcal{S}_{\mathcal{C}}^{(1)}(\rho_{\text{geon}}) = S_{\mathcal{C}}(\rho_{\text{thermal}}) = S_{BH}. \quad (5.30)$$

Now on the bulk side, when we calculate  $\chi_{\mathcal{C}}(\rho_{\text{geon}})$  using the limiting procedure of (5.18) we also obtain  $\chi_{\mathcal{C}} = S_{BH} = \mathcal{S}_{\mathcal{C}}^{(1)}(\rho_{\text{geon}})$ . Again this follows trivially from the fact that the geon spacetime is isometric to AdS-Schwarzschild in the exterior of the horizon.<sup>10</sup> It is intriguing that this calculation relies crucially on the fact that  $S$  depends on the global topology of the spacetime

---

<sup>10</sup>Note that had we not used (5.18) we would have incorrectly obtained  $S_{BH}/2$  since the antipodal identification of the bifurcation surface effectively halves its area. This quotient does not change the area of any other surface of the horizon, so the limit in (5.18) does not know about this discontinuity in the area.

but  $\chi$  does not.

The state  $\rho_{\text{geon}}$  also provides an important counterexample useful for excluding coarse grainings weaker than  $\mathcal{S}^{(1)}$  (see section 5.4.3 below). We will now show that the states  $\rho_{\text{geon}}$  and  $\rho_{\text{thermal}}$  have different two-point functions. Therefore a coarse graining  $\mathcal{S}^{(2)}$  which constraints all one- and two-point function would have  $\mathcal{S}^{(2)}(\rho_{\text{geon}}) < S_{BH}$  by (5.12).

Consider two points  $x, y$  on the boundary of the geon spacetime. In the free field limit, the two-point function is due to Witten diagrams which begin at  $x$  and end at  $y$  in position space. Now because the geon is a quotient of AdS-Schwarzschild, it includes not only the Witten diagrams of AdS-Schwarzschild, but also noncontractable Witten diagrams which wrap around the nontrivial topology and make an additional contribution to the two-point function. Therefore the two point functions of  $\rho_{\text{geon}}$  and  $\rho_{\text{thermal}}$  are not equal.<sup>11</sup>

**(B3) For pure states, the one-point entropy of a region is generally not equal to the one-point region of the complementary region:** This property follows immediately from (B2) since for any Cauchy surface  $\mathcal{C}$ ,  $\mathcal{S}_{\mathcal{C}}^{(1)} = 0$  but it was just shown that for some pure states  $\mathcal{S}_{\mathcal{C}}^{(1)} > 0$ . More generally if we take an arbitrary region  $\mathcal{A}$  and act with an arbitrary unitary operator supported only in  $\mathcal{A}^C$  we do not change  $\mathcal{S}_{\mathcal{A}}^{(1)}$ , but will generally change  $\mathcal{S}_{\mathcal{A}^C}^{(1)}$  because the one-point functions are not invariant under unitary transformations.

---

<sup>11</sup>See [224] for explicit calculations showing that physical detectors placed outside of the horizon register the difference between the states  $\rho_{\text{geon}}$  and  $\rho_{\text{thermal}}$ .

Similarly, it was shown in [25] (by applying the Gao-Wald focusing theorem [91]) that generally  $\chi_{\mathcal{A}} \neq \chi_{\mathcal{A}^c}$  for arbitrary regions  $\mathcal{A}$ .

(B4) **The one-point entropy reduces to the fine-grained entropy for states which are thermal with respect to geometric flows:** This fact is of particular interest because Hubeny and Rangamani conjectured that  $\chi_{\mathcal{A}} = S_{\mathcal{A}}$  if  $\rho_{\mathcal{A}}$  is thermal [25]. By (L1), our proposal reproduces this result whenever the modular Hamiltonian (as defined in (L1)) of  $\rho$  is a linear combination of local operators.<sup>12</sup> This happens to be true for all known cases in which  $\chi_{\mathcal{A}} = S_{\mathcal{A}}$ . The known cases are

- Spherical regions  $\mathcal{A}$  in the vacuum state  $\rho_{\text{vacuum}}$  of a CFT. In this case the modular Hamiltonian of  $\rho_{\mathcal{A}}$  is a diffeomorphism generator, and therefore a linear function of  $T_{\mu\nu}$  [101].
- Spherical regions  $\mathcal{A}$  of the rotating BTZ geometry. A change of coordinates maps the BTZ wedge  $\blacklozenge_{\mathcal{A}}$  onto a wedge to the AdS geometry and the previous argument applies.
- Certain eternal black holes (including charged and dilatonic black holes) are also dual to thermal states of the entire CFT. The modular Hamiltonian is simply a linear combination of global charges of the spacetime and therefore  $\mathcal{S}_{\mathcal{C}}^{(1)} = S_{\mathcal{C}} = S_{BH} = \chi_{\mathcal{C}}$ , where  $\mathcal{C}$  is a Cauchy surface. (This shows that we need our coarse graining to constrain, not just the one-point function of the boundary stress-energy tensor  $T_{\mu\nu}$ , but also the CFT operators which are dual to the bulk dilaton and gauge

---

<sup>12</sup>See section 5.4.3 for comparison with the results of [219].

fields.)

(B5) **The one-point entropy is bounded by a thermal entropy:** For any region  $\mathcal{A}$

$$\mathfrak{S}_{\mathcal{A}}^{(1)}(\rho_{\mathcal{A}}) \leq S_{\mathcal{A}}(\rho_{\text{thermal}}), \quad (5.31)$$

where

$$\rho_{\text{thermal}} = Z^{-1} \exp(-\beta_{\rho} H). \quad (5.32)$$

In the previous expression  $H \in \{\mathcal{O}_m\}$  and  $\beta_{\rho}$  is a constant chosen so that  $\langle H \rangle_{\rho_{\mathcal{A}}} = \langle H \rangle_{\rho_{\text{thermal}}}$ .

To see this note that  $\rho_{\text{thermal}}$  maximizes the entropy subject to what amounts to a subset of the constraints (5.9), and imposing additional constraints cannot raise the entropy. Furthermore, by (L1)  $\mathfrak{S}_{\mathcal{A}}^{(1)}(\rho_{\text{thermal}}) = S_{\mathcal{A}}(\rho_{\text{thermal}})$  so we obtain (5.31).

Now in the case of a Cauchy surface of an eternal black hole spacetime which is dual to a thermal state, the modular Hamiltonian  $H$  is a linear combination of energy, angular momentum, and other global charges. In this case, (B4) implies that (5.31) is saturated, so our proposal requires that black holes which are dual to thermal states always maximize their area subject to the constraint of fixed energy and other global charges.

(B6) **The one-point entropy is invariant under alterations to the dual spacetime outside the causal wedge:** Consider some boundary region



$\mathcal{A}$  with a classical reduced density matrix  $\rho_{\mathcal{A}}$  dual to a bulk causal wedge  $\blacklozenge_{\mathcal{A}}$ . Now consider an alteration of the bulk spacetime which leaves the casual wedge of  $\mathcal{A}$  unchanged, but which is not necessarily small anywhere else. Such an alteration will produce a new reduced density matrix  $\tau_{\mathcal{A}}$ , which is in general *not* equal to  $\rho_{\mathcal{A}}$ . To see this, note that for generic spacetimes the extremal surface  $\mathfrak{E}_{\mathcal{A}}$  lies outside of  $\blacklozenge_{\mathcal{A}}$  [25, 195]. Therefore it is possible for a modification of the spacetime outside of  $\blacklozenge_{\mathcal{A}}$  to change the fine grained entropy, so that  $S_{\mathcal{A}}(\tau_{\mathcal{A}}) \neq S_{\mathcal{A}}(\rho_{\mathcal{A}})$ . Now it follows immediately from the AdS/CFT dictionary (5.25) and the locality of the bulk theory that any such perturbation will not change the one-point functions in  $D[\mathcal{A}]$ . Therefore  $\tau_{\mathcal{A}} \in T_{\mathcal{A}}(\rho_{\mathcal{A}})$ , so  $\mathcal{S}_{\mathcal{A}}^{(1)}(\tau_{\mathcal{A}}) = \mathcal{S}_{\mathcal{A}}^{(1)}(\rho_{\mathcal{A}})$ .

By construction we have not modified the causal wedge  $\blacklozenge_{\mathcal{A}}$  so it immediately follows that  $\chi_{\mathcal{A}}(\tau_{\mathcal{A}}) = \chi_{\mathcal{A}}(\rho_{\mathcal{A}})$ .

(B7) **The one-point entropy is  $\chi$ -preserving in perturbation theory:** Whereas (B6) showed that perturbations which do not alter  $\blacklozenge_{\mathcal{A}}$  (and therefore  $\chi_{\mathcal{A}}$ ) preserve the one point functions, here we show a limited converse: that small perturbations which do not alter the one-point functions preserve  $\blacklozenge_{\mathcal{A}}$  and therefore  $\chi_{\mathcal{A}}$ .

The problem of reconstructing the bulk given boundary data in asymptotically AdS spacetimes has been extensively studied [11, 12, 13, 14, 15, 16, 17, 18]. In the linearized bulk theory the boundary data in  $\mathcal{A}$  is sufficient to reconstruct the fields in  $\blacklozenge_{\mathcal{A}}$ ; this construction can also be extended to the full nonlinear theory order-by-order in the interaction strength  $\sqrt{G_N}$  [17, 18]. In

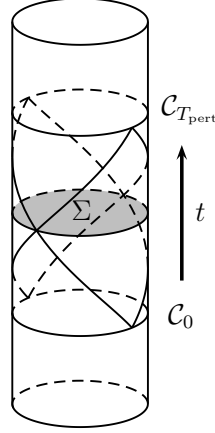

Figure 5.4: A sketch of the setup described in (B8). The spacetime is perturbatively close to vacuum AdS for a sufficiently long time  $T_{\text{pert}}$  that a bulk Cauchy surface  $\Sigma$  can be reconstructed from the boundary one-point functions.

the correspondence limit, this boundary data reduces to one-point functions; therefore in the classical, perturbative regime,  $\blacklozenge_{\mathcal{A}}$  can be reconstructed from the one-point functions in  $D[\mathcal{A}]$ .

Now consider two states  $\rho_{\mathcal{A}}$  and  $\tau_{\mathcal{A}}$  which are perturbatively close to one another and have the same one-point functions. Because they have the same one-point functions it follows immediately that  $\mathcal{S}_{\mathcal{A}}^{(1)}(\rho_{\mathcal{A}}) = \mathcal{S}_{\mathcal{A}}^{(1)}(\tau_{\mathcal{A}})$ . Now in the bulk theory, the one-point functions completely determine the causal wedges associated with both states; therefore  $\blacklozenge_{\mathcal{A}}(\rho_{\mathcal{A}}) = \blacklozenge_{\mathcal{A}}(\tau_{\mathcal{A}})$  which implies  $\chi_{\mathcal{A}}(\rho_{\mathcal{A}}) = \chi_{\mathcal{A}}(\tau_{\mathcal{A}})$ .

- (B8) **The one-point entropy of a Cauchy surface vanishes for certain collapsed black holes:** Consider a classical spacetime which is perturbatively close to vacuum AdS for a time  $0 \leq t \leq T_{\text{pert}}$ . Let  $\mathcal{C}_t$  be a family of boundary Cauchy surfaces and let  $\mathcal{M}$  be the boundary region between  $\mathcal{C}_0$  and  $\mathcal{C}_{T_{\text{pert}}}$ . Let  $T_{\text{pert}}$  be large enough that  $J_{\text{bulk}}^+[\mathcal{M}] \cap J_{\text{bulk}}^-[\mathcal{M}]$  contains

a bulk Cauchy surface  $\Sigma$  (see Fig. 5.4). Let the set of all such states be called  $R_{\chi=0}$ . The reconstruction results explained in (B7) imply that the classical Cauchy data on  $\Sigma$  (and therefore the entire bulk spacetime) can be reconstructed from the boundary one-point functions in  $\mathcal{M}$ .<sup>13</sup> Thus, the one-point entropy  $\mathcal{S}_{\mathcal{C}_t}^{(1)}(\rho_{\mathcal{C}_t})$  counts all states which correspond to this bulk geometry in the correspondence limit. This quantity is precisely what is calculated by the Ryu-Takayanagi entropy  $S_{\mathcal{C}_t}(\rho_{\mathcal{C}_t})$  so<sup>14</sup>

$$\mathcal{S}_{\mathcal{C}_t}^{(1)}(\rho_{\mathcal{C}_t}) = S_{\mathcal{C}_t}(\rho_{\mathcal{C}_t}) = 0. \quad (5.33)$$

Now, by construction  $\partial_+ \blacklozenge_{\mathcal{C}_t}$  and  $\partial_- \blacklozenge_{\mathcal{C}_t}$  do not intersect. This means that  $\chi_{\mathcal{C}_t} = 0$ , and so

$$\mathcal{S}_{\mathcal{C}_t}^{(1)}(\rho_{\mathcal{C}_t}) = \chi_{\mathcal{C}_t} = 0. \quad (5.34)$$

In [225, 226, 227] it is shown that AdS is perturbatively unstable to black hole collapse. Thus almost all of the solutions we have considered will become black holes at late times. The physical interpretation of  $\chi_{\mathcal{C}_t} = 0$  for these states is that the one-point entropy is sensitive to the boundary data in the CFT, prior to the time that the state thermalizes.

---

<sup>13</sup>Note that by invoking (B7) we are implicitly assuming that the coarse grained state is perturbatively close to original state. This seems plausible at least for *some* class of small perturbations.

<sup>14</sup>Recall from section 5.3.2 that we are only interested in the order  $N^2$  pieces of  $S$  and  $\mathcal{S}^{(1)}$ .

### 5.4.3 Comparison with other coarse-grained entropies

We begin this section by showing that for the class of perturbative states  $R_{\chi=0}$  considered in (B8),  $\mathcal{S}^{(1)}$  is the strongest, classical  $\chi$ -preserving coarse grained entropy. The key feature of the states  $R_{\chi=0}$  are i) that there is a one-to-one map between boundary one-point functions and bulk causal wedges  $\blacklozenge_{\mathcal{C}_t}$  and ii) that  $S_{\mathcal{C}_t} = 0 = \chi_{\mathcal{C}_t}$ .

Since each classical state in  $R_{\chi=0}$  is its own coarse graining, it follows that  $\mathcal{S}^{(1)}$  is  $\chi$ -preserving and classical over  $R_{\chi=0}$ . Next, consider a stronger  $\chi$ -preserving coarse graining  $\tilde{\mathcal{S}} \succ \mathcal{S}^{(1)}$ . If  $\tilde{\mathcal{S}} \not\equiv \mathcal{S}^{(1)}$  then there must exist at least  $O(N^2)$  classically distinguishable bulk wedges  $\blacklozenge^{(i)}$  that satisfy the constraints of  $\tilde{\mathcal{S}}$  for some classical state  $\rho_{\mathcal{C}_t}$ . All of these causal wedges have the same (vanishing) von Neumann entropy by the inequality  $S_{\mathcal{C}_t} \leq \chi_{\mathcal{C}_t} = 0$ , therefore the coarse-grained state  $\sigma_{\mathcal{C}_t}$  must be a mixture of the states dual to the  $\blacklozenge^{(i)}$ . In other words,  $\sigma_{\mathcal{C}_t}$  is not classical and so  $\tilde{\mathcal{S}}$  is not classical over  $R_{\chi=0}$ . Therefore there is no stronger, classical  $\chi$ -preserving coarse graining than  $\mathcal{S}^{(1)}$  over the states  $R_{\chi=0}$ .

Note that by (B6) and (B7),  $\mathcal{S}^{(1)}$  is also  $\chi$ -preserving and classical in the perturbative regime for states with  $\chi > 0$ . However, it is no longer trivial to show that any stronger  $\chi$ -preserving coarse graining is nonclassical. Still, we conjecture that the obstacles to extending our argument are technical and that in fact  $\mathcal{S}^{(1)}$  is the strongest such coarse graining in this perturbative regime (in which we maximize entropy subject to the assumption that  $\sigma$  is perturbatively close to  $\rho$ ).

Throwing all caution to the winds, we conjecture that  $\mathcal{S}^{(1)}$  continues to be the strongest classical  $\chi$ -preserving coarse graining non-perturbatively. One can explore this question in classical general relativity, by asking if the bulk recon-

struction results discussed in (B7) extend to the non-perturbative regime. If not, it seems likely that the one-point functions do not fix  $\chi$ , in which case our conjecture  $\mathcal{S}^{(1)} = \chi$  can only work perturbatively. In this case, it would be of interest to attempt to construct the strongest, classical  $\chi$ -preserving coarse graining explicitly (if it exists) and see if it is a candidate for the dual of  $\chi$ .

So, since we are not certain that  $\mathcal{S}^{(1)}$  is classical and  $\chi$ -preserving, it is worth considering if any weaker coarse graining might be viable. One possibility is to consider a coarse-grained entropy  $\mathcal{S}^{(2)} \prec \mathcal{S}^{(1)}$  which constrains all one- and two-point functions. However, we can show that  $\mathcal{S}^{(2)}$  is inconsistent with the additivity property (B1). Let  $\mathcal{A}$  and  $\mathcal{B}$  be two spherical regions on the vacuum AdS boundary, separated by a small spacelike gap. For such regions the fine-grained entropy is subadditive:  $S_{\mathcal{A}\cup\mathcal{B}} \leq S_{\mathcal{A}} + S_{\mathcal{B}}$ .

By (B4) we know that  $\mathcal{S}_{\mathcal{A}}^{(1)}(\rho_{\mathcal{A}}) = \mathcal{S}_{\mathcal{A}}^{(2)}(\rho_{\mathcal{A}}) = S_{\mathcal{A}}(\rho_{\mathcal{A}})$  and similarly for  $\mathcal{B}$ . However, the two-point functions connecting regions  $\mathcal{A}$  and  $\mathcal{B}$  do not vanish, therefore  $\sigma_{\mathcal{A}\cup\mathcal{B}}^{(1)} \notin T_{\mathcal{A}\cup\mathcal{B}}^{(2)}(\rho_{\mathcal{A}\cup\mathcal{B}})$  (see (B1)). So, by (5.12) we have

$$\mathcal{S}_{\mathcal{A}\cup\mathcal{B}}^{(2)}(\rho_{\mathcal{A}\cup\mathcal{B}}) < \mathcal{S}_{\mathcal{A}}^{(2)}(\rho_{\mathcal{A}}) + \mathcal{S}_{\mathcal{B}}^{(2)}(\rho_{\mathcal{B}}). \quad (5.35)$$

Since the fine-grained entropy is subadditive at order  $N^2$  we presume that  $\mathcal{S}^{(2)}$  is as well.

One could try to evade this problem by strengthening  $\mathcal{S}^{(2)}$ . Consider a coarse graining  $\mathcal{S}^{(2\Diamond)}$  which constrains all one-point functions and those two-point functions for which both points are causally connected (c.f. [228]). Now,  $\mathcal{S}^{(2\Diamond)}$  manifestly satisfies the additivity property (B1). However, consider the states  $\rho_{\text{geon}}$

and  $\rho_{\text{thermal}}$  discussed in (B2). These states have the same one-point functions but different two-point functions, therefore,  $\rho_{\text{thermal}} \notin T^{(2\Diamond)}(\rho_{\text{geon}})$ . It then follows from (5.12) that for a Cauchy surface  $\mathcal{C}$

$$\mathcal{S}_{\mathcal{C}}^{(2\Diamond)}(\rho_{\text{geon}}) < \mathcal{S}_{\mathcal{C}}^{(1)}(\rho_{\text{geon}}) = \chi_{\mathcal{C}}. \quad (5.36)$$

Assuming as above that this difference is of order  $N^2$ , this rules out  $\mathcal{S}^{(2\Diamond)}$  and any weaker coarse graining as the dual of  $\chi$ .

Another conceivable weaker coarse graining might constrain all of the one-point functions and all Wilson loops. However, Wilson loops are dual to extremal surfaces in the bulk geometry [229, 230] and extremal surfaces can lie outside of  $\Diamond_{\mathcal{A}}$  [231], in obvious tension with (B6).<sup>15</sup>

It is also conceivable that some incomparable coarse graining  $\hat{\mathcal{S}} \parallel \mathcal{S}^{(1)}$  that combines partial data about the one-point functions and partial data about more complicated operators produce a candidate for the dual of  $\chi$ . However, this type of construction seems likely to suffer from at least some of the shortcomings of both the stronger and weaker coarse grainings considered above.

Freivogel and Mosk have put forward a different kind of proposal for the dual of  $\chi$  [219]. Let  $D[\mathcal{A}]$  be a simple causal diamond (i.e. it takes the form  $J^-(p) \cap J^+(q)$  where  $p$  and  $q$  are points) on a conformally flat boundary metric. The region  $D[\mathcal{A}]$  thus has a time-translation conformal Killing vector  $\xi$ . Now let  $U = \exp(-iHt)$  be the unitary operator corresponding to the flow with respect to  $\xi$ . The proposal

---

<sup>15</sup>On the other hand, it has been argued [232, 233] that this duality is only valid in appropriately analytic spacetimes, and therefore it is not straightforward to draw inferences about causality. So, this tension might have a resolution.

of [219] is that for such regions,  $\chi_{\mathcal{A}} = \tilde{S}_{\mathcal{A}}(\rho_{\mathcal{A}})$ , where

$$\tilde{S}_{\mathcal{A}}(\rho_{\mathcal{A}}) = S_{\mathcal{A}} \left( \sum_i P_i \rho_{\mathcal{A}} P_i \right), \quad (5.37)$$

and the  $P_i$  above are projection operators onto the eigenbasis of the operator  $H$ . If  $\rho_{\mathcal{A}}$  is a thermal state with modular Hamiltonian  $H$  then  $\tilde{S}_{\mathcal{A}}(\rho_{\mathcal{A}}) = S_{\mathcal{A}}(\rho_{\mathcal{A}})$ , which reproduces the result (B4) above. Note that the projection  $P_i \rho_{\mathcal{A}} P_i$  removes all off diagonal elements in the  $H$  basis, which makes the resulting state time independent. This corresponds to a coarse graining in which the constraints  $\{\mathcal{O}_m\}$  consist of all functions of  $H$ .

The projection (5.37) is equivalent to taking a time average of the state  $\rho_{\mathcal{A}}$ , which we call  $\bar{\rho}_{\mathcal{A}}$ . Unfortunately, this implies that it is *not* dual to  $\chi$ . For consider an out of equilibrium state  $\rho_{\mathcal{A}}$  which eventually (for very early and late modular times  $t$ ) settles to an equilibrium state. Let us suppose that in the bulk dual, this area of the future horizon at late times is equal to  $A_{\text{final}}$ , as is the area of the past horizon at early times. By the second law of horizons,  $\chi(\rho_{\mathcal{A}}) < A_{\text{final}}/4G_N$ . But inside of  $\diamond_{\mathcal{A}}$ , the time average of this bulk state is a stationary horizon with area  $A_{\text{final}}$ . Hence  $\chi(\bar{\rho}_{\mathcal{A}}) = A_{\text{final}}/4G_N$ , so  $\chi(\rho_{\mathcal{A}}) < \chi(\bar{\rho}_{\mathcal{A}})$  and the coarse graining  $\tilde{S}$  is not  $\chi$ -preserving.<sup>16</sup>

#### 5.4.4 Possible tests of $\mathcal{S}^{(1)} = \chi$

While there is a great deal of data describing the behavior of  $\chi$  in complex circumstances (see [203, 204]),  $\mathcal{S}^{(1)}$  seems to be much less amenable to numerical

<sup>16</sup>We owe this argument to Don Marolf.

calculation. To test the conjecture, one may wish to look for aspects of  $\mathcal{S}^{(1)}$  (such as its divergence structure) which may be easy to calculate.

An even better strategy for testing  $\mathcal{S}^{(1)} = \chi$  might be to identify circumstances in which our conjecture can be tested entirely within general relativity. If two solutions exist with the same one-point functions and different values of  $\chi$ , then this would show that  $\mathcal{S}^{(1)}$  is not  $\chi$ -preserving and therefore not the dual of  $\chi$ . Since the one-point functions correspond to the asymptotic values of classical fields, this leads to predictions about the allowed spacetimes on the bulk side.

Below we list a few special regimes in which it might be particularly easy to construct tests of our conjecture.

(C1) **Spherical symmetry:** One strategy for finding solutions with the same one-point data is to exploit Birkhoff’s theorem, which states that any spherically symmetric solution to general relativity with compactly supported matter will have one-point functions which are identical to AdS-Schwarzschild. Now it is certainly possible to construct initial data that is spherically symmetric and has compactly supported matter. However, evolving such initial data will generally lead to radiation which will propagate to the AdS boundary in finite time. If this radiation can be suppressed in such a way that the presence of some matter alters  $\chi_{\mathcal{A}}$  but no radiation reaches  $D[\mathcal{A}]$ , such a spacetime would be a counterexample to our conjecture that  $\mathcal{S}^{(1)} = \chi$ . There are several no-go theorems in general relativity that forbid “horizonless solitons” (see e.g. [234] and references therein); however because the radiation only needs to be suppressed for a finite time these theorems are not sufficient by themselves to protect our conjecture.



In particular it would be interesting to attempt to construct such a solution using branes which have vanishing back reaction on the spacetime in the  $N \rightarrow \infty$  limit.<sup>17</sup> Even though it is possible to construct spherically symmetric branes in AdS these branes are still localized on the compact dimensions and therefore may radiate via Kaluza-Klein modes.

- (C2) **Null shock waves:** Another approach to constructing counterexamples is to study null shock waves which pass through  $\blacklozenge_{\mathcal{A}}$  but which do not have an endpoint on  $D[\mathcal{A}]$ . In [237, 238] it is shown that the effect of such shock waves on the boundary one-point functions is heavily suppressed. Thus it may be possible to bound the change in  $\mathcal{S}^{(1)}$  caused by these shock waves and compare it with the associated change in  $\chi$ .
- (C3) **Generic coarse grained states:** Consider a generic boundary region  $\mathcal{A}$  and associated with a bulk causal wedge  $\blacklozenge_{\mathcal{A}}$ . By (B6) arbitrary perturbations outside of  $\blacklozenge_{\mathcal{A}}$  will not affect  $\mathcal{S}_{\mathcal{A}}^{(1)}$  or  $\chi_{\mathcal{A}}$  but they will generically change  $S_{\mathcal{A}}$ . Now, by [195] we must have  $S_{\mathcal{A}} < \chi_{\mathcal{A}}$  for smooth generic spacetimes satisfying the null energy condition. However, if  $\chi_{\mathcal{A}} - S_{\mathcal{A}}$  can be made arbitrarily small then continuity would imply that if  $\mathcal{S}^{(1)}$  is classical, then it is dual to  $\chi$ .

Another approach would be to construct non-smooth spacetimes for which  $S_{\mathcal{A}} = \chi_{\mathcal{A}}$  exactly. Such spacetimes are reminiscent of the “disentangled” Rindler wedges considered in [239]. There it was shown that the Rindler horizons become singular when the entanglement between the two regions

---

<sup>17</sup>Another intriguing possibility would be to study the Coulomb branch solutions considered in [235, 236].

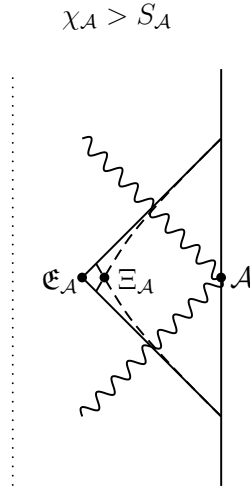

Figure 5.5: Matter reflecting off the AdS boundary. The solid line to the right represents the AdS boundary and  $\mathcal{A}$  is a spherical region (see (C5)).

is no longer maximal. These disentangled wedges could serve as a model for more general coarse grained states.

- (C4) **Comparing divergences:** Freivogel and Mosk [219] have calculated the logarithmically divergent piece of  $\chi_{\mathcal{A}}$  for arbitrary regions  $\mathcal{A}$  on a flat boundary in  $D = 4$  spacetime dimension. They find that this logarithmic divergence is universal (i.e. independent of the state and the regulator) and that it *cannot* be expressed as an integral of local geometric boundary quantities. This means that unlike  $S_{\mathcal{A}}$ , the divergent terms in  $\chi_{\mathcal{A}}$  are not dominated by vacuum correlations. A greater understanding of coarse-grained states could allow comparison between the divergences of  $\mathcal{S}^{(1)}$  and those of  $\chi$ . (Note that if  $\sigma$  is a classical state, it must generically be nonsmooth at the causal surface, as shown in (C3). It is not surprising therefore that its divergences might differ from that of  $\rho$ .)

(C5) **Reflecting matter off the AdS boundary:** Consider a spherical region  $\mathcal{A}$  on the boundary of vacuum AdS. The reduced density matrix associated with this region is the thermal state  $\rho_{\mathcal{A}}$  (see (B4)). Now consider a state  $\bar{\rho}_{\mathcal{A}} = e^{-iJ}\rho_{\mathcal{A}}e^{iJ}$  where  $J$  is a source operator. The spacetime associated with such a state will (for an appropriately chosen  $J$ ) have a matter field bouncing off the AdS boundary (see Fig. 5.5).

Since the von Neumann entropy is preserved by unitary transformations and since  $\rho_{\mathcal{A}}$  is thermal we know that  $\mathcal{S}^{(1)}(\bar{\rho}_{\mathcal{A}}) \geq \mathcal{S}^{(1)}(\rho_{\mathcal{A}})$ . Furthermore  $\bar{\rho}_{\mathcal{A}}$  does not have the same one-point functions as  $\rho_{\mathcal{A}}$  so it is unlikely that  $\mathcal{S}^{(1)}(\bar{\rho}_{\mathcal{A}}) = \mathcal{S}^{(1)}(\rho_{\mathcal{A}})$  for general  $U$ . Similarly, we know that  $\chi_{\mathcal{A}}(\bar{\rho}_{\mathcal{A}}) > \mathcal{S}^{(1)}(\rho_{\mathcal{A}})$ . It is conceivable that the state  $\bar{\rho}_{\mathcal{A}}$  and its dual geometry could be constructed in sufficient detail to allow a precision test of  $\mathcal{S}^{(1)} = \chi$ .

(C6) **Almost-complete Cauchy slices:** Consider an eternal black hole in  $D \geq 4$  spacetime dimensions and consider the quantity  $\Delta S_{\mathcal{A}} = S_{\mathcal{A}}(\rho_{\mathcal{A}}) - S_{\mathcal{A}^C}(\rho_{\mathcal{A}^C})$ . It is well known that

$$\lim_{\mathcal{A}^C \rightarrow \emptyset} \Delta S_{\mathcal{A}} = S_{BH}, \quad (5.38)$$

and in fact  $\Delta S_{\mathcal{A}} = S_{BH}$  even when  $\mathcal{A}^C$  is sufficiently small but finite. In [240] this leveling off of  $\Delta S_{\mathcal{A}}$  is referred to as the entanglement plateaux.

But for the causal surface, there is no plateaux. If we now consider  $\Delta \chi_{\mathcal{A}} = \chi_{\mathcal{A}} - \chi_{\mathcal{A}^C}$  we find that

$$\lim_{\mathcal{A}^C \rightarrow \emptyset} \Delta \chi_{\mathcal{A}} > S_{BH}, \quad (5.39)$$

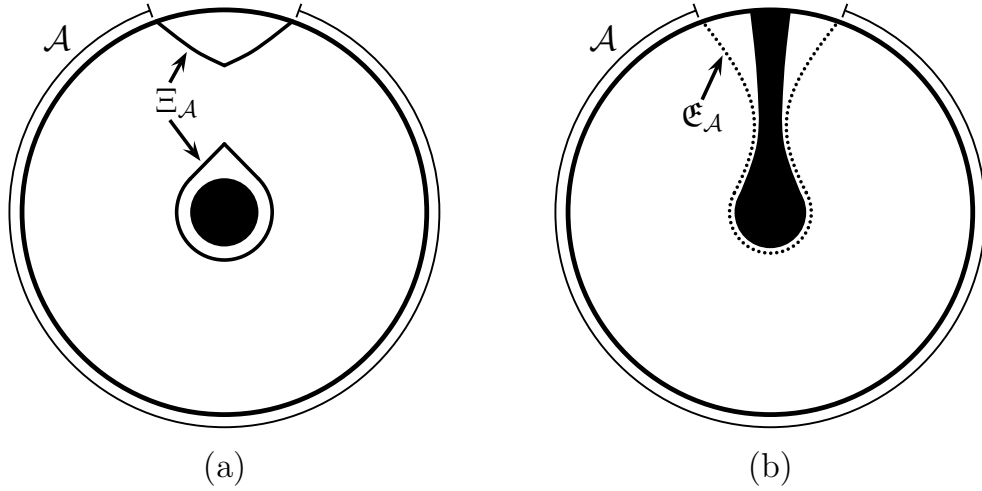

Figure 5.6: (a) A sketch of a  $t = \text{constant}$  slice of the AdS-Schwarzschild solution. Even for very small  $\mathcal{A}^C$ ,  $\chi_{\mathcal{A}}$  does not approach  $S_{BH}$ . See [204] for a precise diagram. (b) A bulk Cauchy surface of the (non-stationary) black funnel-like geometry discussed in the text. The reduced density matrix on  $\mathcal{A}$  is a candidate for a coarse graining of  $\rho_{\mathcal{A}}$ .

even though (B4) says that  $\chi_{\mathcal{A}} = S_{BH}$  when  $\mathcal{A}^C = \emptyset$ . This means that  $\Delta\chi_{\mathcal{A}}$  jumps by a finite amount right when  $\mathcal{A}$  becomes a complete Cauchy surface! This effect is due to the red shift at the horizon, which prevents the causal surface from approaching arbitrarily close to the event horizon (Fig. 5.6(a)). Can  $\mathcal{S}^{(1)}$  also jump in the same way (in the large N limit)? If not, then our conjecture that  $\mathcal{S}_{\mathcal{A}}^{(1)} = \chi_{\mathcal{A}}$  would be falsified.

Our conjecture requires that for arbitrarily small but finite  $\mathcal{A}^C$ , there must exist a state  $\sigma_{\mathcal{A}}$  in  $\mathcal{A}$  that has the same stress tensor  $T_{\mu\nu}$  as the eternal black hole, and has entropy  $S_{\mathcal{A}}(\sigma_{\mathcal{A}}) = \mathcal{S}_{\mathcal{A}}^{(1)}(\rho_{\mathcal{A}})$ . If we assume that  $\mathcal{S}^{(1)}$  is classical, then we can look for such states entirely within classical general relativity. An interesting candidate state can be constructed by patching the region  $\mathcal{A}$  to a Schwarzschild black hole. Consider such a state with a

time reflection symmetry on a Cauchy surface  $\mathcal{C}$  which contains  $\mathcal{A}$ . The horizon of this boundary black hole will extend into the bulk in a manner which might resemble a non-stationary black funnel-like spacetime sketched in Fig. 5.6(b) (see [241, 242, 243, 244]).<sup>18</sup> As noted in (C3),  $\sigma_{\mathcal{A}}$  cannot be smooth, however, it is possible that the required patching of the black hole disrupts the smoothness of the bulk geometry. If it could be shown that such a solution exists and has  $S_{\mathcal{A}}(\sigma_{\mathcal{A}}) = \mathfrak{S}_{\mathcal{A}}(\sigma_{\mathcal{A}}) = \mathfrak{S}_{\mathcal{A}}^{(1)}(\rho_{\mathcal{A}})$  this would provide a nontrivial check on our proposal.

## 5.5 The future one-point entropy

### 5.5.1 Motivation and definition

Consider a pure state in AdS which, after some time, collapses to a black hole and rings down. The HRT proposal assigns such a state zero entropy even at arbitrarily late times. It is appropriate that a fine-grained notion of entropy should assign such a state zero entropy since the initial state is pure, and unitary evolution does not alter the entropy. However, since this state is asymptotically stationary, at late times it is externally indistinguishable from an eternal black hole, which has a nonzero Bekenstein-Hawking entropy. It is therefore tempting to apply the HRT proposal to the eternal black hole geometry, in order to calculate an approximate coarse-grained entropy.

Returning to the collapsing geometry, not only does the HRT entropy vanish

---

<sup>18</sup>This solution can only exist if the one-point functions do not uniquely specify  $\diamond_{\mathcal{A}}$  non-perturbatively. Another interesting candidate for  $\sigma_{\mathcal{A}}$  is the related black droplet solution.

for a Cauchy surface  $\mathcal{C}$ , but so do  $\chi_{\mathcal{C}}$  and  $\mathcal{S}_{\mathcal{C}}^{(1)}$  (at least in the cases considered in (B8)). We attribute this to the fact that the domain  $D[\mathcal{C}]$  over which we coarse grain extends far into the past into the pre-thermalization region, when the geometry could easily be distinguished from a black hole. While this is all perfectly consistent, it is not typically what is meant by a coarse-grained entropy, since it does not allow for thermalization.

Another feature that  $\mathcal{S}^{(1)}$  lacks that we might expect from a coarse-grained entropy is an interesting second law. Technically  $\mathcal{S}_{\mathcal{A}}^{(1)}$  satisfies a second law (just like  $S_{\mathcal{A}}$ ), however only in the trivial sense that

$$\partial_t \left( \mathcal{S}_{\mathcal{A}_t}^{(1)} \right) = 0 \quad (5.40)$$

where  $\mathcal{A}_t$  is a foliation of  $D[\mathcal{A}]$  parameterized by  $t$ .

Motivated by the above concerns, we propose a new set of bulk and boundary quantities which we call the ‘future causal information’  $\phi_{\mathcal{A}}$  and the ‘future one-point entropy’  $\mathcal{S}_{\mathcal{A}}^{(\wedge)}(\rho_{\mathcal{A}})$ . We define

$$\mathcal{S}_{\mathcal{A}}^{(\wedge)}(\rho_{\mathcal{A}}) = \sup_{\tau_{\mathcal{A}} \in T_{\mathcal{A}}^+} [S_{\mathcal{A}}(\tau_{\mathcal{A}})] \quad (5.41)$$

where  $T_{\mathcal{A}}^+$  is the set of all density matrices which satisfy the constraints

$$\text{Tr}[\mathcal{O}_m \rho_{\mathcal{A}}] = \text{Tr}[\mathcal{O}_m \tau_{\mathcal{A}}] \quad (5.42)$$

where now the  $\{\mathcal{O}_m\}$  in (5.42) are the set of all one-point functions of the fields with support only on  $D^+[\mathcal{A}]$ .

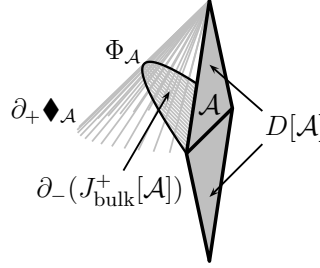

Figure 5.7: A sketch of the construction of  $\Phi_{\mathcal{A}}$  described in the text.  $D[\mathcal{A}]$  is the boundary domain of dependence of  $\mathcal{A}$  and  $\Phi_{\mathcal{A}}$  extends into the bulk (see text).

We conjecture that in the absence of boundary sources, and in the correspondence limit of section 5.3.2, the bulk dual of  $\mathfrak{S}_{\mathcal{A}}^{(\wedge)}$  is given by

$$\mathfrak{S}_{\mathcal{A}}^{(\wedge)} = \phi_{\mathcal{A}} := \frac{\text{Area}[\Phi_{\mathcal{A}}]}{4G}, \quad (5.43)$$

where  $\Phi_{\mathcal{A}}$  is the codimension-two surface (see Fig. 5.7)

$$\Phi_{\mathcal{A}} := \partial_+ \blacklozenge_{\mathcal{A}} \cap \partial_-(J_{\text{bulk}}^+[\mathcal{A}]). \quad (5.44)$$

To summarize we have formed a new conjecture by modifying our old conjecture in two ways: the operators  $\mathcal{O}_m$  are now supported on  $D^+[\mathcal{A}]$  only as opposed to  $D^+[\mathcal{A}] \cup D^-[\mathcal{A}]$ , and the associated bulk surface is  $\partial_+ \blacklozenge_{\mathcal{A}} \cap \partial_-(J_{\text{bulk}}^+[\mathcal{A}])$  as opposed to  $\partial_+ \blacklozenge_{\mathcal{A}} \cap \partial_- \blacklozenge_{\mathcal{A}}$ . We have again restricted our conjecture to theories without boundary sources for the reasons given in appendix A.2.

### 5.5.2 Properties of the future one-point entropy

Note that lemma (L1) and properties (A2) and (A3) still apply to  $\mathcal{S}^{(\wedge)}$ . However, (A1) no longer applies, since  $\mathcal{S}^{(\wedge)}$  now depends on the choice of  $\mathcal{A}$ , not just on  $D[\mathcal{A}]$ . In addition  $\mathcal{S}^{(\wedge)}$  has the following properties:

(D1) **The future one-point entropy equals the one-point entropy if  $\mathcal{A}$**

**is its own past:** If  $\mathcal{A} = D^-[\mathcal{A}]$  then  $D^+[\mathcal{A}] = D[\mathcal{A}]$ , and it follows that  $\mathcal{S}_{\mathcal{A}}^{(\wedge)} = \mathcal{S}_{\mathcal{A}}^{(1)}$ . In this case we also have  $\phi_{\mathcal{A}} = \chi_{\mathcal{A}}$ . Thus if  $\mathcal{S}^{(\wedge)} = \phi$  then it follows immediately that  $\mathcal{S}^{(1)} = \chi$ .

(D2) **The future one-point entropy is additive for spacelike separated**

**regions:** Consider two spacelike separated regions  $\mathcal{A}$  and  $\mathcal{B}$  for which  $D^+[\mathcal{A}] \cap D^+[\mathcal{B}] = \emptyset$ . Now if  $D^+[\mathcal{A}] \cap D^+[\mathcal{B}] = \emptyset$  then it immediately follows that  $D[\mathcal{A}] \cap D[\mathcal{B}] = \emptyset$ . Therefore, exactly as in (B1), we can consider the state  $\rho_{\mathcal{A}} \otimes \rho_{\mathcal{B}}$  which differs from  $\rho_{\mathcal{AUB}}$  by correlations between  $\mathcal{A}$  and  $\mathcal{B}$ . Since the constraints are not sensitive to such correlations we obtain  $\sigma_{\mathcal{AUB}} = \sigma_{\mathcal{A}} \otimes \sigma_{\mathcal{B}}$  and

$$\mathcal{S}_{\mathcal{AUB}}^{(\wedge)} = \mathcal{S}_{\mathcal{A}}^{(\wedge)} + \mathcal{S}_{\mathcal{B}}^{(\wedge)}. \quad (5.45)$$

Since  $D[\mathcal{A}] \cap D[\mathcal{B}] = \emptyset$ , boundary causality requires that there are no bulk causal curves connecting  $D^+[\mathcal{A}]$  and  $D^+[\mathcal{B}]$ ; hence

$$\phi_{\mathcal{AUB}} = \phi_{\mathcal{A}} + \phi_{\mathcal{B}}. \quad (5.46)$$



(D3) **The future one-point entropy obeys a non-trivial second law:** Let  $\mathcal{A}$  and  $\mathcal{B}$  be two surfaces such that  $D[\mathcal{A}] = D[\mathcal{B}]$  and let  $\mathcal{B}$  lie nowhere to the past of  $\mathcal{A}$ . Then

$$\mathfrak{S}_{\mathcal{A}}^{(\wedge)} \leq \mathfrak{S}_{\mathcal{B}}^{(\wedge)} \quad (5.47)$$

due to the fact that the latter coarse graining has fewer constraints.

This matches the classical second law of causal horizons [207], which says that for any causal horizon,

$$\phi_{\mathcal{A}} \leq \phi_{\mathcal{B}}. \quad (5.48)$$

In the case where  $\mathcal{C}$  is a Cauchy surface,  $\phi_{\mathcal{C}}$  corresponds to a slice of the global event horizon. In the case where  $D[\mathcal{A}]$  is a simple causal diamond, it corresponds to slices of an AdS-Rindler type causal horizon [208]. In the most general case, it corresponds to the boundary of the past of some set of points  $\mathcal{Z}$  on the AdS-boundary. This is a slightly more general notion of causal horizon than that considered by [208] (which required the causal horizon to be the boundary of the past of a *single* future-infinite worldline) but it still obeys a second law [245].

Note that although every choice of boundary slice  $\mathcal{B} \in \mathcal{D}[\mathcal{A}]$  maps to some slice  $\phi_{\mathcal{B}}$  of the causal horizon, the map is neither one-to-one, nor onto. If the null surface shot out from  $\mathcal{B}$  develops caustics before intersecting the future horizon, then it is possible to modify parts of  $\mathcal{B}$  without affecting  $\phi_{\mathcal{B}}$ .

Similarly, for any given slice  $\phi$  there is no guarantee that there exists any dual choice of  $\mathcal{B}$ , since a null surface shot out from  $\phi$  may also develop caustics. Nevertheless it is remarkable that, if our conjecture is true, there exists an infinite-dimensional family of slices of the future horizon, whose (geometrical) bulk second law is dual to a (thermodynamic) boundary second law.

(D4) **The future one-point entropy is a stronger coarse graining than the one-point entropy:** Since the maximization associated with  $\mathfrak{S}_{\mathcal{A}}^{(\wedge)}$  involves fewer constraints than that associated with  $\mathfrak{S}_{\mathcal{A}}^{(1)}$ , it follows that

$$S \prec \mathfrak{S}^{(1)} \prec \mathfrak{S}^{(\wedge)}, \quad (5.49)$$

where we have also used (A2). Similarly from (D3) we have

$$S \leq \chi \leq \phi. \quad (5.50)$$

(D5) **The future one-point entropy thermalizes:** Let  $\mathcal{C}_t$  be a foliation of Cauchy surfaces of a spacetime that starts as a small perturbation to AdS, but ultimately settles down to one or more black holes. At early times, by (D1), we recover

$$\lim_{t \rightarrow -\infty} \mathfrak{S}_{\mathcal{C}_t}^{(\wedge)}(\rho_{\mathcal{C}_t}) = \mathfrak{S}_{\mathcal{C}_t}^{(1)}(\rho_{\mathcal{C}_t}) = 0. \quad (5.51)$$

But at late times, the black holes ring down and the field theory state thermalizes. In particular the one-point functions approach those of a thermal

state, and we obtain

$$\lim_{t \rightarrow \infty} \mathfrak{S}_{\mathcal{C}_t}^{(\wedge)}(\rho_{\mathcal{A}_t}) = S_{\mathcal{C}_t}(\rho_{\text{thermal}}) = S_{BH}. \quad (5.52)$$

In the bulk geometry it follows from the causal structure of the spacetime that

$$\lim_{t \rightarrow -\infty} \phi_{\mathcal{C}_t} = 0, \quad \lim_{t \rightarrow \infty} \phi_{\mathcal{C}_t} = S_{BH}. \quad (5.53)$$

Again, we have used the limiting procedure of section 5.3.2 to exclude Poincaré recurrences from our analysis.

There are also spacetimes which remain perturbatively close to AdS even at late times (see e.g. [246]), for which  $\phi_{\mathcal{C}_t} = 0$  for all  $t$ . By the bulk reconstruction argument of (B8) these are precisely the state for which we would expect to have  $\mathfrak{S}_{\mathcal{C}_t}^{(\wedge)} = 0$  for all  $t$  as well, since the entire bulk geometry can be reconstructed from one-point functions even at late times.

**(D6) The future one-point entropy reduces to the fine-grained entropy for states which are thermal with respect to geometric flows:** By (B4), if  $\mathcal{A}$  is a spherical region of the boundary of vacuum AdS, a BTZ black hole, or a Cauchy surface of an eternal black hole, then

$$S_{\mathcal{A}}(\rho_{\mathcal{A}}) = \mathfrak{S}_{\mathcal{A}}^{(1)}(\rho_{\mathcal{A}}) = \mathfrak{S}_{\mathcal{A}}^{(\wedge)}(\rho_{\mathcal{A}}). \quad (5.54)$$

This is also true for the associated bulk quantities even though  $\Phi_{\mathcal{A}} \neq \mathfrak{E}_{\mathcal{A}} = \Xi_{\mathcal{A}}$ . This is because in each of these special cases, the future and past

horizons of  $D[\mathcal{A}]$  are stationary. As a result,  $\Phi_{\mathcal{A}}$  is connected to  $\Xi_{\mathcal{A}}$  by a null congruence with zero expansion, so that  $\chi_{\mathcal{A}} = \phi_{\mathcal{A}}$ .

**(D7) The future one-point entropy is bounded by a thermal entropy:**

Just as in (B5), for any region  $\mathcal{A}$  if  $\rho_{\text{thermal}}$  is a thermal state with modular Hamiltonian  $H \in \{\mathcal{O}_m\}$  satisfying  $\langle H \rangle_{\rho_{\mathcal{A}}} = \langle H \rangle_{\rho_{\text{thermal}}}$  then

$$\mathcal{S}_{\mathcal{A}}^{(\wedge)}(\rho_{\mathcal{A}}) \leq \mathcal{S}_{\mathcal{A}}^{(\wedge)}(\rho_{\text{thermal}}). \quad (5.55)$$

However, now we find that this bound is saturated not just by eternal black holes, but also by collapsed black holes in the limit that  $\mathcal{A}$  sufficiently far to the future of the formation of the event horizon.

It is worth emphasizing again that if our conjecture  $\mathcal{S}^{(\wedge)} = \phi$  is correct, then the thermodynamic second law of  $\mathcal{S}^{(\wedge)}$  of (D3) is the bulk dual of the Hawking area increase theorem [207], as applied to certain kinds of causal horizons [208, 245]. In this way our proposal provides a quantum mechanical interpretation of the area law in terms of a thermodynamic second law in the boundary theory.

### 5.5.3 Generalization to arbitrary boundary regions

The generalization of  $\chi$  to  $\phi$  suggests a further generalization to more general bulk wedges. Consider two regions  $\mathcal{A}_-$  and  $\mathcal{A}_+$  which have the same domain of dependence  $D[\mathcal{A}_-] = D[\mathcal{A}_+]$  and for which  $\mathcal{A}_+$  is everywhere to the future of  $\mathcal{A}_-$ , i.e.  $\mathcal{A}_+ \in J^+[\mathcal{A}_-]$ . A natural generalization of (5.44) is then to consider the

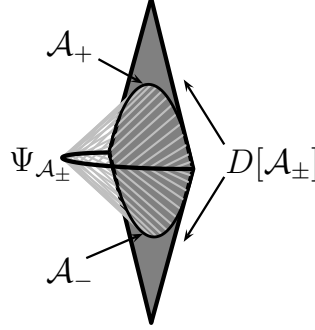

Figure 5.8: A sketch of the construction of  $\Psi_{\mathcal{A}_-, \mathcal{A}_+}$  described in the text.  $D[\mathcal{A}_-] = D[\mathcal{A}_+]$  is the boundary domain of dependence of  $\mathcal{A}_{\pm}$  and  $\Psi_{\mathcal{A}_-, \mathcal{A}_+}$  extends into the bulk (see text).

surface (see Fig. 5.8)

$$\Psi_{\mathcal{A}_-, \mathcal{A}_+} = \partial_+(J_{\text{bulk}}^-[ \mathcal{A}_+ ]) \cap \partial_-(J_{\text{bulk}}^+[ \mathcal{A}_- ]). \quad (5.56)$$

Based on our previous experience it is tempting to conjecture that  $\psi := \text{Area}[\Psi]/4G_N$  is dual to a coarse-grained entropy  $\mathbb{S}^{(1)}$  whose constraints  $\{\mathcal{O}_m\}$  are all one-point function supported in the region  $J^+[\mathcal{A}_-] \cap J^-[\mathcal{A}_+]$ . However, this proposal meets with serious difficulties right away.

Let  $\mathcal{C}_-$  and  $\mathcal{C}_+$  be two Cauchy surfaces on the boundary of the AdS vacuum so that the region between  $\mathcal{C}_-$  and  $\mathcal{C}_+$  forms a strip. The constraints associated with this strip include the total energy of the spacetime, which vanishes for vacuum AdS. Since the AdS vacuum is the unique state in the theory with  $E = 0$ , it follows that  $\mathbb{S}_{\mathcal{C}_-, \mathcal{C}_+}^{(1)} = 0$  for any choice of  $\mathcal{C}_-$  and  $\mathcal{C}_+$ . Yet in the bulk, we have  $\psi_{\mathcal{C}_-, \mathcal{C}_+} = 0$  only if  $\mathcal{C}_-$  and  $\mathcal{C}_+$  are separated by an AdS light crossing time or more. Therefore, we find that  $\psi_{\mathcal{C}_-, \mathcal{C}_+} > \mathbb{S}_{\mathcal{C}_-, \mathcal{C}_+}^{(1)}$  for certain choices of  $\mathcal{C}_-, \mathcal{C}_+$ .

It is hard to imagine how we might modify  $\mathbb{S}^{(1)}$  in order to make a credible

candidate for the dual of  $\psi$ . One possibility is to introduce finite imprecision into the constraints, roughly as proposed in footnote 8. In particular we would need to the precision to depend on the width of the strip. This is in some ways reminiscent of the Heisenberg uncertainty principle, which limits the precision with which the energy can be measured by coupling to a classical system for a finite time. Bounds of this kind were found in the “holographic thought experiments” of [92]. However, it is unclear how to translate these ideas into a precise proposal for the dual of  $\psi$ .

A very different way of interpreting  $\psi_{c_-,c_+}$  is put forward in [247, 228]. Balasubramanian et. al. propose that  $\psi_{c_-,c_+}$  measures the entanglement between spatial regions separated by  $\Psi_{c_-,c_+}$ , which in the field theory roughly translates to entanglement between UV and IR degrees of freedom. It would be very interesting to know if this entanglement entropy could be formulated as a coarse-grained entropy which preserves the appropriate IR degrees of freedom.

## 5.6 Discussion

In summary, we have examined two coarse-grained entropies  $\mathcal{S}^{(1)}$  and  $\mathcal{S}^{(\wedge)}$  in detail and found that they are plausibly dual to the causal holographic information  $\chi$  and the future causal information  $\phi$ , respectively. We have tested these conjectures by finding shared properties, and eliminating several classes of alternate proposals.

The evidence for our conjectures includes that i) both  $\mathcal{S}^{(1)}$  and  $\mathcal{S}^{(\wedge)}$  are additive, as are their bulk duals (see (B1), (D2)), ii)  $\mathcal{S}^{(1)} = \chi$  and  $\mathcal{S}^{(\wedge)} = \phi$  for thermal states and for the pure geon state (see (B2), (B4), (D6), (D7)), and iii) in certain

circumstances, the classical bulk spacetime can be reconstructed from the one-point functions (see (B7)), as discussed below. Additionally, for the future one-point entropy, iv)  $\mathcal{S}^{(\wedge)}$  obeys a second law (see (D3)), and thermalizes in a way which correctly reproduces the early and late time entropy of a collapsing black hole (see (D5)).

Assuming that the dual of  $\chi$  is a member of a particularly nice class of coarse grainings, we can show that it must be the *strongest* such coarse graining. This class consists of those coarse-grainings which preserve  $\chi$  and map classical states to classical states. If the dual of  $\chi$  belongs to this class, then (at least for these classical states) it must be the strongest possible such coarse graining, at order  $N^2$ . In certain perturbative contexts, we have shown that  $\mathcal{S}^{(1)}$  does indeed belong to this class, and for the states  $R_{\chi=0}$  considered in 5.4.3 we have also shown that it is the strongest. Even for perturbations to geometries with  $\chi > 0$ , the bulk reconstruction theorems discussed in (B7) suggest that it is still the strongest.

Our conjecture is on more dubious ground non-perturbatively, but we have identified situations in which it can be tested using classical general relativity. Several tests (some of which are non-perturbative) are listed in section 5.4.4. We believe that experts will be able to falsify or confirm our conjecture using existing analytic and numerical methods.

The most striking feature of  $\mathcal{S}^{(\wedge)}$  is that it obeys a nontrivial second law (cf. (D3)). This allows us to describe the thermalization of CFT states, in a way which—if our conjecture is correct—is dual to the Hawking area theorem in the bulk. However, the second law is a general feature of any coarse graining based on maximizing entropy subject to diminishing constraints. So this property is not

unique to the one-point constraints. However the bulk reconstruction theorems tell us that the one-point entropy thermalizes in a way which is qualitatively similar to the collapse of a black hole as argued in (D5).

Finally we note that even though we have only analyzed the coarse-grained entropies  $\mathcal{S}^{(1)}$  and  $\mathcal{S}^{(\wedge)}$  in the correspondence limit, these quantities are well defined at finite  $N$ , if one includes all local operators as prescribed in section 5.4.1. Are there still nice bulk duals for these quantities?

One can start by looking at the semiclassical regime. In the boundary, this corresponds to taking the  $N \rightarrow \infty$  limit, yet keeping terms subleading in  $N$ . In this regime, the area of the HRT must be surface be corrected by adding a term which equal to the entanglement entropy across the surface [248]. In other words,  $S$  on the boundary is dual to the *generalized entropy* of the HRT surface.

It is natural to suppose that  $\chi$  and  $\phi$  must be corrected in the same way. Note that  $\phi$  no longer obeys a second law because quantum matter fields can violate the null energy condition. However,  $\mathcal{S}^{(\wedge)}$  still obeys a second law, and so does the generalized entropy associated with  $\phi$  [159]. But unlike  $\chi$  and  $\phi$ , the generalized entropy is not additive. Perhaps this proposal can be saved by restricting to connected boundary regions, or by including higher-point functions at finite precision in  $N$  (cf. footnote 8).



# Chapter 6

## Deriving the First Law of Black Hole Thermodynamics without Entanglement

### 6.1 Introduction

The Wald-Iyer theorem [249, 250] establishes that the first law of black hole thermodynamics [96] is a general consequence of diffeomorphism invariance. In the context of AdS/CFT, it has been shown by Faulkner et al. [23] that a special case of the Wald-Iyer theorem has a precise microscopic interpretation as the ‘first law of entanglement entropy’ [251]. This insight turned out to be very powerful, as it led to a derivation of the linearized Einstein equation [23] from the Ryu-Takayanagi formula [19, 20] (see also [198, 199, 200, 201, 22, 202]).<sup>1</sup> Subsequent

---

<sup>1</sup>Note that the linearized EOM can also be derived (under a different set of assumptions) from conformal invariance (see [252]).

work extended this derivation to include universal coupling to matter [24] (with an additional assumption argued for in [248]).

Given this recent success, it seems both interesting and important to answer the question ‘What is the holographic dual of the Wald-Iyer theorem?’. In light of the previous paragraph one might naively guess that the Wald-Iyer theorem is the bulk dual of the first law of entanglement entropy, however, as we will show below, this guess is incorrect. Instead we will argue that the Wald-Iyer theorem is dual to a coarse-grained first law. More precisely, we will prove that for a certain class of states defined in section 6.3

$$\delta S_W = \delta \mathcal{S}^{(1)}. \quad (6.1)$$

Here  $S_W$  is the Wald entropy,  $\mathcal{S}^{(1)}$  is the one-point entropy of [29], and  $\delta$  is a variation which acts infinitesimally on both the bulk spacetime and the boundary density matrix. The one-point entropy (which we define in section 6.2) is a coarse-grained measure of information that is only sensitive to the expectation value of local operators (i.e. one-point functions) within a boundary causal domain of dependence. Our main result is that (6.1) holds even for pure states, for which the Wald entropy is not a measure of entanglement of the associated CFT state.

For many states, including the AdS-Rindler state considered in [23], (6.1) does reduce to the first law of entanglement entropy  $\delta S_W = \delta S$ , where  $S$  is the von Neumann entropy. Still, there are two reasons why our interpretation of the Wald entropy as a coarse-grained entropy is useful.

First, there are other states for which  $\delta S_W \neq \delta S$  but (6.1) continues to hold.

Examples of such states are

- topological-geon/single-exterior black holes [222]
- the “B-states” of [253], which model a CFT excited state after a global quench (see [254])
- black hole microstates of either the fuzzy (see e.g. [255]) or fiery [256, 257] persuasion
- the late time limit of a collapsed black hole.

What these states have in common is that, even though they are dual to pure (or nearly pure) CFT states, they each have a bulk region which resembles a black hole, including obeying a thermodynamic first law.<sup>2</sup> This latter behavior is captured by (6.1).

Second, a corollary of our result and [23] is that the linearized gravitational equations of motion can also be derived from (6.1). This observation suggests that it might be possible to derive gravitational equations of motion from a coarse graining of the microscopic degrees of freedom, in the spirit of [259]. This proposal could be tested by deriving the linearized equations using states for which  $\mathcal{S}^{(1)} \neq S$  or by checking to see if (6.1) continues to hold beyond linear order.

Equation (6.1) also has implications for the proposal of [29]. In [29] it was conjectured that, in the Einstein gravity limit, the one-point entropy could be computed from the ‘Ryu-Takayanagi’-like formula

$$\mathcal{S}^{(1)}(\rho_{\mathcal{A}}) = \frac{\text{Area}[C_{\mathcal{A}}]}{4G} =: \chi_{\mathcal{A}}. \quad (6.2)$$

---

<sup>2</sup>See also [258].

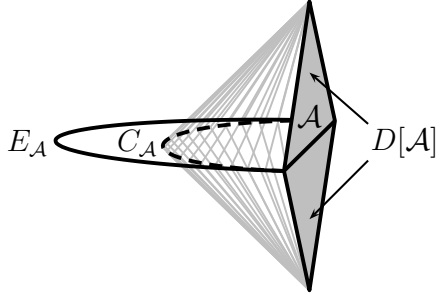

Figure 6.1: A sketch of a boundary region  $\mathcal{A}$ , its associated domain of dependence  $D[\mathcal{A}]$ , the causal information surface  $C_{\mathcal{A}}$  and the RT/HRT surface  $E_{\mathcal{A}}$  [19, 20, 194].  $D[\mathcal{A}]$  lies on the AdS boundary while  $C_{\mathcal{A}}$  and  $E_{\mathcal{A}}$  extend into the bulk spacetime. The wedge shaped region enclosed by  $D[\mathcal{A}]$  along with the bulk past and future horizons of  $D[\mathcal{A}]$  (gray lines) is called the causal wedge of  $\mathcal{A}$  and denoted  $\blacklozenge_{\mathcal{A}}$ .

Here  $\rho_{\mathcal{A}}$  is the reduced density matrix associated with a CFT region  $\mathcal{A}$ ,  $C_{\mathcal{A}}$  is the intersection of the past and future horizons of  $D[\mathcal{A}]$ ,  $D[\mathcal{A}]$  is the boundary domain of dependence of  $\mathcal{A}$ , and  $\chi$  is the causal holographic information (CHI) of [25] defined above in (6.2).<sup>3</sup> Since (6.1) is a first variation of (6.2) for a class of special states, our proof of (6.1) provides new evidence for the conjecture  $\mathcal{S}^{(1)} = \chi$ .

The organization of the rest of the paper is as follows. In section 6.2 we review the definition of  $\mathcal{S}^{(1)}$  and briefly state some of the motivation for (6.2). In section 6.3 we prove our main result  $\delta\mathcal{S}^{(1)} = \delta S_W$  and provide examples of states that satisfy the assumptions of our proof. In section 6.4 we summarize our results and comment on their relationship to the related work of [228, 260, 261, 262]. In Appendix A.3 we outline a strategy for testing (6.2) non-perturbatively.

<sup>3</sup>The proposal as stated applies only to Einstein-Hilbert gravity, but there is a natural generalization to higher derivative theories of gravity by replacing the Area functional with the entropy functional of [108, 103, 104, 109]. In this note we will only be interested in cases for which this entropy functional reduces to the Wald entropy.

## 6.2 The one point entropy $\mathcal{S}^{(1)}$

In this section we briefly define and motivate the one-point entropy  $\mathcal{S}^{(1)}$ , we refer the reader to [29] for additional details. The one-point entropy is defined as

$$\mathcal{S}^{(1)}(\rho_{\mathcal{A}}) = \text{lub}_{\tau_{\mathcal{A}} \in T_{\mathcal{A}}} S(\tau_{\mathcal{A}}), \quad (6.3)$$

where  $\rho_{\mathcal{A}}$  is the reduced density matrix associated with a spacelike region  $\mathcal{A}$  of the CFT,  $S(\tau_{\mathcal{A}}) := -\text{Tr}[\tau_{\mathcal{A}} \log(\tau_{\mathcal{A}})]$  is the von Neumann entropy, and ‘lub’ stands for the least upper bound, in this case over the states  $T_{\mathcal{A}}$ . Here,  $T_{\mathcal{A}}$  is the set of all states  $\tau_{\mathcal{A}}$  which satisfy

$$\text{Tr}[\mathcal{O}(x)\tau_{\mathcal{A}}] = \text{Tr}[\mathcal{O}(x)\rho_{\mathcal{A}}], \quad x \in D[\mathcal{A}], \quad (6.4)$$

for all local, gauge invariant CFT operators  $\mathcal{O}(x)$ . In words,  $\mathcal{S}^{(1)}(\rho_{\mathcal{A}})$  is the least upper bound of the von Neumann entropy of all state  $\tau_{\mathcal{A}}$  which reproduce the one-point functions of all local operators in the domain of dependence  $D[\mathcal{A}]$ .<sup>4</sup>

Heuristically, we might imagine an experimental physicist performing all local measurements in  $D[\mathcal{A}]$  and trying to estimate the state  $\rho_{\mathcal{A}}$  based only on this data. Having no other information at her disposal, this experimentalist would be justified in assigning equal probabilities to any state that reproduces her measurements. The entropy of the resulting ensemble is precisely  $\mathcal{S}^{(1)}(\rho_{\mathcal{A}})$ .

One feature of (6.2) is that it implies that  $\text{Area}[C_{\mathcal{A}}]$  can be expressed as a function of local measurements in  $D[\mathcal{A}]$ . In the large  $N$  limit CFT correlation

---

<sup>4</sup>See [220] for a non-holographic application of this type of coarse-graining.

functions factorize and local measurements are roughly equivalent to measuring all correlators at leading order in a  $1/N$  expansion. This intuition along with the bulk reconstruction literature [11, 12, 13, 14, 15, 16, 17, 18, 263] suggests that, at least perturbatively, the one-point functions are sufficient to construct the classical spacetime up to  $C_{\mathcal{A}}$ .

An important implication of (6.3) is that whenever the modular Hamiltonian of  $\rho$  is local, we must have  $\mathcal{S}^{(1)}(\rho) = S(\rho)$ . Recall that the modular Hamiltonian  $H$  is defined for any positive definite  $\rho$  by the relation

$$\rho = Z^{-1} \exp(-H), \quad (6.5)$$

where  $Z = \text{Tr}[\exp(-H)]$  and  $H$  is generically a complicated non-local operator. If  $H$  is local (or more precisely the integral of a local operator) then  $\langle H \rangle_{\tau_{\mathcal{A}}}$  is fixed by the constraints (6.4). It is a standard result of thermodynamics that  $\rho$  maximizes the von Neumann entropy subject to the constraint of fixed  $\langle H \rangle$ , therefore (6.3) reduces to  $\mathcal{S}^{(1)}(\rho) = S(\rho)$ . In AdS/CFT,  $H$  is local only for very special states, such as stationary black holes and AdS-Rindler, and in all such cases we find that the minimum area surface  $E_{\mathcal{A}}$  picked out by the Ryu-Takayanagi (RT) conjecture [19, 20] (or equivalently the minimum area, extremal surface picked out by the Hubeny-Rangamani-Takayanagi (HRT) conjecture [194]) and the causal information surface  $C_{\mathcal{A}}$  coincide [25]. The RT/HRT conjectures state that  $S = \text{Area}(E_{\mathcal{A}})/4G$ , which implies that for these special states  $\chi = S$ . Slightly abusing the standard terminology, we will refer to states of this kind as ‘thermal’ even when  $H$  is not the generator of time translations.

For any density matrix of the form (6.5) a simple calculation yields the first law of entanglement entropy

$$S(\rho + \delta\rho) = S(\rho) + \text{Tr}[\delta\rho H] + O(\delta\rho^2). \quad (6.6)$$

We will use this identity frequently below.

Finally, if we assume that CFT states with semi-classical bulk geometries are appropriately generic (see (A.3)), then (6.2) reduces to a statement about the classical equations of motion which in principle is testable. The interested reader may consult Appendix A.3 for the details.

### 6.3 A Proof of $\delta S_W = \delta\mathcal{S}^{(1)}$

In this section we prove (6.1) under a set of assumptions. We then provide examples of states satisfying those assumptions.

#### 6.3.1 The General Case

The assumptions for our proof of (6.1) are as follows. Let  $\mathcal{A}$  be a spacelike region of the CFT (possibly an entire Cauchy surface) and let  $\rho_{\mathcal{A}}$  be the reduced density matrix on  $\mathcal{A}$ . We assume that:

1. The dual bulk state is well approximated by a semiclassical bulk geometry, at least up to an order Planck length distance from the boundary of the causal wedge  $\blacklozenge_{\mathcal{A}}$  (see Fig. 6.1). The rest of the bulk need not be semiclassical.

2. The interior of  $\blacklozenge_{\mathcal{A}}$  is stationary with Killing vector  $t$  and is isometric to the interior of another spacetime region  $\hat{\blacklozenge}_{\mathcal{A}}$  which has a bifurcate Killing horizon as its boundary. Let  $\xi$  be a Killing vector in the interior of  $\blacklozenge_{\mathcal{A}}, \hat{\blacklozenge}_{\mathcal{A}}$ , which vanishes on the bifurcation surface of  $\hat{\blacklozenge}_{\mathcal{A}}$ . We fix the normalization of  $t$  and  $\xi$  by requiring that, at the conformal boundary,  $t \cdot t = -1$  and  $\xi \cdot t = -1$ .
3. The one-point functions of  $\rho_{\mathcal{A}}$  are identical to the one-point functions of a state  $\rho_{th}$ , where  $\rho_{th}$  is of the form

$$\rho_{th} = Z^{-1} \exp(-H_{th}), \quad H_{th} = \int_{\Sigma} n^a T_{ab} \xi^b. \quad (6.7)$$

Here  $Z = \text{Tr}[\exp(-H_{th})]$ ,  $\Sigma$  is a Cauchy surface of the boundary region  $D[\mathcal{A}]$ ,  $n^a$  is the associated unit normal,  $T_{ab}$  is the boundary stress tensor, and  $\xi^a$  is the pullback of  $\xi$  to the conformal boundary.

Assumptions (1) and (2) are needed so that we may invoke the Wald-Iyer theorem. We were careful to word (2) so as not to require that the boundary of  $\blacklozenge_{\mathcal{A}}$  be a Killing horizon. This distinction will be important later when we consider geometries like the  $\mathbb{RP}_n$  geon which have an exterior region that is isometric to a stationary black hole, but do not have a bifurcate Killing horizon.<sup>5</sup>

Assumption (3) expresses the intuition that stationary geometries are consistent with thermal states. Known examples suggest that (3) holds if and only if (1) and (2) also hold, which implies that it may be possible to derive (3) from (1) and (2). It would be an improvement to eliminate (3), but for now we will take

---

<sup>5</sup>Note that the surface integral often used to calculate the Wald entropy arises from integrating a total divergence over a bulk Cauchy surface. For this reason the Wald entropy, properly defined, is the same on  $\blacklozenge_{\mathcal{A}}$  and  $\hat{\blacklozenge}_{\mathcal{A}}$ , which is why assumption (2) is sufficient for our purposes.



it as an assumption and argue that it is satisfied for the states listed in the introduction.

For simplicity we have not considered charged black holes, but it would be straightforward to do so using the results of [264]. We now begin the proof.

**Theorem: Assumptions (1)-(3) imply  $\delta S_W = \delta \mathcal{S}^{(1)}$ , where  $\delta$  is a variation that acts infinitesimally both on the boundary state  $\rho_A$  and the bulk geometry.**

Our strategy will be to calculate  $\delta S_W$  and  $\delta \mathcal{S}^{(1)}$  separately and compare the answers. We begin with  $\delta S_W$ . By assumptions (1) and (2) we may invoke the Wald-Iyer theorem which states that

$$\delta S_W = \delta \mathcal{H}, \quad (6.8)$$

where  $\mathcal{H}$  is the canonical charge associated with the Killing vector  $\xi$ .<sup>6</sup> It has been shown explicitly [36, 70] (or more generally in [37]) that  $\mathcal{H}$  is equal to the holographic charge associated with  $\xi$  up to a term that is constant on the space of solutions, i.e.

$$\langle H_{th} \rangle := \int_{\Sigma} n^a T_{ab} \xi^b = \mathcal{H} + c, \quad (6.9)$$

where  $T_{ab}$  is the holographic stress tensor computed using the counter term subtraction prescription of [52, 53]. Since  $c$  is a constant on the space of solutions, it will vanish when we take the variational derivative with respect to the bulk

---

<sup>6</sup> $\mathcal{H}$  is defined by the differential equation  $\delta \mathcal{H} = \omega(\delta \phi, \mathcal{L}_{\xi} \phi)$ , where  $\omega$  is the symplectic structure,  $\mathcal{L}_{\xi}$  is the Lie derivative along  $\xi$ , and  $\phi$  represents the metric and any other field content of the theory. We have chosen conventions which set the temperature to unity.

solution, so we may rewrite (6.8) as

$$\delta S_W = \delta \langle H_{th} \rangle. \quad (6.10)$$

Now we turn to calculating  $\delta \mathcal{S}^{(1)}$ . Let the variation of the bulk geometry considered above correspond to a variation of the density matrix

$$\rho_{\mathcal{A}} \rightarrow \rho_{\mathcal{A}} + \delta \rho. \quad (6.11)$$

We now wish to compute

$$\delta \mathcal{S}^{(1)} = \delta \mathcal{S}^{(1)}(\rho_{\mathcal{A}} + \delta \rho) - \mathcal{S}^{(1)}(\rho_{\mathcal{A}}) + O(\delta \rho^2). \quad (6.12)$$

It turns out to be useful to consider the family of states  $\rho_{\mathcal{A}} + \alpha \delta \rho$ , where  $\alpha$  is an arbitrary constant. Recall from section 6.2 that  $\mathcal{S}^{(1)}$  is calculated by maximizing the entropy over states which satisfy a constraint of the form (6.4). By assumption (3),  $\rho_{\mathcal{A}} + \alpha \delta \rho$  must have identical one-point functions to  $\rho_{th} + \alpha \delta \rho$ , therefore

$$\mathcal{S}^{(1)}(\rho_{\mathcal{A}} + \alpha \delta \rho) = \mathcal{S}^{(1)}(\rho_{th} + \alpha \delta \rho) \geq S(\rho_{th} + \alpha \delta \rho), \quad (6.13)$$

where the last inequality follows from the definition (6.3).

Also by assumption (3) we have  $\mathcal{S}^{(1)}(\rho_{th}) = S(\rho_{th})$  because  $\rho_{th}$  has a local modular Hamiltonian (by the argument given just below (6.5)). Inserting this

relation into (6.13) and using (6.6) gives

$$\alpha (\delta\mathcal{S}^{(1)} - \text{Tr}[\delta\rho H_{th}]) + O(\alpha^2) \geq 0, \quad (6.14)$$

This inequality must hold for arbitrary  $\alpha$ , therefore the term in parenthesis vanishes,<sup>7</sup> and

$$\delta\mathcal{S}^{(1)} = \delta \langle H_{th} \rangle. \quad (6.15)$$

Comparing (6.10) and (6.15) we see that the proof is complete. We now prove a corollary which will be used below.

**Corollary:** Under the same assumptions as above,  $\delta S_W = \delta S(\rho_A)$  if and only if  $\rho_A = \rho_{th}$  for  $\rho_{th}$  as defined in (6.7).

If  $\rho_A = \rho_{th}$  then it follows immediately from (6.6) and (6.10) that

$$\delta S = \delta \langle H_{th} \rangle = \delta S_W. \quad (6.16)$$

Conversely, say that  $\delta S_W = \delta S$  for all  $\delta\rho$ . It then also follows from (6.6) and (6.10) that

$$\text{Tr}[\delta\rho H_{th}] = \text{Tr}[\delta\rho H_A], \quad (6.17)$$

where  $H_A$  is the modular Hamiltonian of  $\rho_A$ . But (6.17) can only hold for arbitrary  $\delta\rho$  if  $H_A = H_{th}$ , which implies that  $\rho_A = \rho_{th}$ . This completes our proof of the

---

<sup>7</sup>Thanks to Aron Wall for pointing out that my original argument could be considerably simplified.

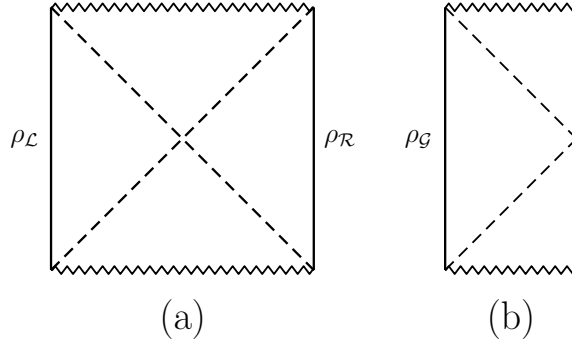

Figure 6.2: (a) A causal diagram AdS Schwarzschild. The reduced density matrix  $\rho_{\mathcal{L}}$  is an example of a state for which  $\delta S_W = \delta S$ . (b) A causal diagram of the geon spacetime described in the text.

corollary.

### 6.3.2 Stationary Examples

There are many examples of states which satisfy assumptions (1)-(3). One natural example comes from the thermofield double state, which is dual to the two sided AdS-Schwarzschild geometry [265]. If we let  $\mathcal{L}$  be a Cauchy surface of the left boundary (see Fig. 6.2(a)), then  $\blacklozenge_{\mathcal{L}}$  is the exterior region of AdS-Schwarzschild, which satisfies (1) and (2). The reduced density matrix of the left asymptotic region,  $\rho_{\mathcal{L}}$ , is already of the form (6.7), therefore (3) is satisfied. Additionally,  $\rho_{\mathcal{L}}$  satisfies the condition of the corollary, therefore  $\delta \mathcal{S}^{(1)} = \delta S$  and (6.1) reduces to the first law of entanglement entropy.

As promised in the introduction we will now show that there exist states for which  $\delta \mathcal{S}^{(1)} \neq \delta S$  but (6.1) still holds. By the corollary proved in section 6.3.1 this amounts to showing that there exists a state satisfying assumptions (1)-(3) for a density matrix  $\rho_{\mathcal{A}}$  that is *not* a thermal state of the form (6.7).

In fact there are large classes of such states. One class of examples are known as topological geons [222]. A simple example of a geon is the (AdS)  $\mathbb{RP}_n$  geon (see e.g. [149]). This solution can be constructed from a  $t = 0$  Cauchy slice of maximally extended AdS-Schwarzschild by taking a  $\mathbb{Z}_2$  quotient about the bifurcation surface  $\mathcal{B}$  and identifying antipodal points on  $\mathcal{B}$ . The resulting surface has a topology  $\mathbb{RP}_n$  where  $n$  is the dimension of the Cauchy surface, hence the name. The maximal evolution of this new surface is a smooth spacetime with one asymptotic region (see Fig. 6.2(b)).

Let  $\mathcal{G}$  be a Cauchy surface of the geon boundary with associated density matrix  $\rho_{\mathcal{G}}$ . By construction the interior of  $\blacklozenge_{\mathcal{G}}$  is identical to the exterior of the AdS-Schwarzschild black hole, therefore the CFT state  $\rho_{\mathcal{G}}$  satisfies assumptions (1) and (2). Furthermore, by the usual AdS/CFT dictionary the one-point functions of  $\rho_{\mathcal{G}}$  are identical to the one point functions of  $\rho_{\mathcal{L}}$ , the density matrix of the left boundary of AdS-Schwarzschild.<sup>8</sup> So the state  $\rho_{\mathcal{G}}$  also satisfies assumption (3).

It only remains to show that  $\rho_{\mathcal{G}} \neq \rho_{\mathcal{L}}$ . This is most easily seen by calculating the entropy of both states. The entropy of  $\rho_{\mathcal{L}}$  is given by  $S(\rho_{\mathcal{L}}) = S_W \sim N^2$ . The geon geometry, on the other hand, has vanishing Ryu-Takayanagi entropy, which implies that the entropy  $\rho_{\mathcal{G}}$  is parametrically smaller than  $N^2$ . Other arguments, given in [265] and explained in detail in [266] (see also [223, 267, 232]) indicate that  $\rho_{\mathcal{G}}$  can be chosen to be a pure state.<sup>9</sup> Therefore, by the corollary proved in

---

<sup>8</sup>Modulo an issue related to choice of conformal frame, which is non-trivial in the presence of a conformal anomaly (see [266]). However, this anomaly term only modifies  $H_{th}$  by a constant  $c$  as in (6.9), which we have already accounted for. Thanks to Kostas Skenderis for pointing this out to me.

<sup>9</sup>Up to this point we had not completely specified  $\rho_{\mathcal{G}}$ .

section 6.3,  $\rho_{\mathcal{G}}$  is a state for which

$$\delta S_W = \delta \mathcal{S}^{(1)} \neq \delta S. \quad (6.18)$$

As mentioned in the introduction, another state satisfying assumptions (1)-(3) is the B-state constructed in [254] and studied holographically in [253]. This state is a pure CFT state meant to model a global quench, in which the Hamiltonian of the theory is changed abruptly. Hartman and Maldacena [253] argued that bulk geometry of the B-state can be obtained by slicing the maximally extended AdS-Schwarzschild geometry in half and terminating the spacetime in an end of the world brane. They then used the Ryu-Takayanagi proposal to reproduce the time evolution of the entanglement entropy calculated in the field theory by Calabrese and Cardy [254].

It follows immediately from the construction described above that the B-state spacetime has a conformal diagram like Fig. 6.2(b) and satisfies (1)-(3) by the same arguments as in the geon case. Since the B-state is pure, (6.18) also follows just as for the geon states.

As our last example we consider the firewall [256, 257] and fuzzball (see [255]) proposals. Both proposals predict that black hole states are ensembles of pure states each of which matches the classical geometry from asymptotic infinity up to a few Planck lengths from the horizon, and beyond this stretched horizon the semiclassical description fails. These microstates—which have been explicitly constructed for certain external black holes (see [268, 269, 270] for a review)—provide another example of pure states which satisfy (1)-(3).

### 6.3.3 Collapsed black holes

Another interesting class of pure (or nearly pure) state black holes are given by black holes formed from collapse. States of this kind satisfy (1) but not (2) because the resulting geometry is not stationary. As a result, we cannot directly apply the theorem of section 6.3 to these states. However, we can make some progress if we consider collapsed black holes that asymptote to stationary black holes at late times.

Let  $\rho_{\mathcal{C}}$  be a state describing a black hole formed from collapse that settles down to a stationary black hole defined on a Cauchy surface  $\mathcal{C}$ . Let  $\rho_{th}$  be a thermal state of the form (6.7) dual to that stationary black hole, and assume that the one-point functions of  $\rho_{\mathcal{C}}$  and  $\rho_{th}$  agree in the late time limit.

Now consider a perturbed state  $\rho_{\mathcal{C}} + \delta\rho$  which also asymptotes to a stationary black hole dual to the thermal state  $\tilde{\rho}_{th}$ . By our assumptions, the difference in the Wald entropy  $\delta S_W$  between  $\rho_{\mathcal{C}}$  and  $\rho_{\mathcal{C}} + \delta\rho$  at late times is equal to the difference in the Wald entropy between  $\rho_{th}$  and  $\tilde{\rho}_{th}$  (calculated at any time, since these black holes are stationary). We can now apply our theorem and obtain

$$\lim_{T \rightarrow \infty} \delta S_W = \delta \langle H_{th} \rangle = \delta \mathcal{S}^{(1)}(\rho_{th}), \quad (6.19)$$

where  $H_{th}$  is the modular Hamiltonian of  $\rho_{th}$ ,  $T$  parameterizes a foliation of the collapsed black hole horizon, and  $\delta \mathcal{S}^{(1)}(\rho_{th})$  is the difference of the one-point entropy between the two stationary black holes.

Eq. (6.19) equates  $\delta \langle H_{th} \rangle$  and  $\delta \mathcal{S}^{(1)}(\rho_{th})$ , but the latter quantity is not the same as  $\delta \mathcal{S}^{(1)}(\rho_{\mathcal{C}})$ . This is because the one-point functions of  $\rho_{\mathcal{C}}$  and  $\rho_{th}$  only agree at

late times. However the one-point entropy can be generalized to capture only the late time behavior of the black hole. This generalization was called the future one point entropy  $\mathcal{S}^{(\wedge)}$  in [29] and is defined as in (6.3) and (6.4) with the replacement  $D[\mathcal{A}] \rightarrow D^+[\mathcal{A}]$ . That is to say,  $\mathcal{S}^{(\wedge)}$  is a coarse-grained entropy that constrains the expectation values of local operators in the *future* domain of dependence of  $\mathcal{A}$ . It follows immediately from this definition that  $\mathcal{S}^{(\wedge)}$  also satisfies a second law in the sense that  $\partial_t \mathcal{S}^{(\wedge)}(\rho_{\mathcal{A}_t}) \geq 0$ , where  $\mathcal{A}_t$  is a foliation of  $D[\mathcal{A}]$ .

It follows from our assumption that the one-point functions of  $\rho_{\mathcal{C}}$  and  $\rho_{th}$  only agree at late times (along with an additional assumption that  $\mathcal{S}^{(\wedge)}$  is suitably continuous) that

$$\lim_{T \rightarrow \infty} \delta S_W = \lim_{t \rightarrow \infty} \delta \mathcal{S}^{(\wedge)}(\rho_{\mathcal{C}_t}), \quad (6.20)$$

where  $\mathcal{C}_t$  a foliation of the boundary spacetime. This is the analog of (6.1) for black holes formed from collapse. It would be interesting in future work to compare these two quantities at large but finite times  $t, T$ .

## 6.4 Discussion

In this note we have shown that the bulk first law for a class of stationary geometries is dual to the coarse-grained first law associated with the one-point entropy  $\mathcal{S}^{(1)}$  and that there exist CFT pure states for which this coarse-graining is necessary for (6.1) to hold. Our results imply that  $S_W$  is not strictly a measure of entanglement in the CFT.

It remains to ask if our results are unique, i.e. is  $\mathcal{S}^{(1)}$  the only coarse-grained



entropy which is equal to the Wald entropy to linear order? The answer turns out to be no, any coarse-grained entropy which fixes the expectation value of the modular Hamiltonian will do the job. To be definite let  $\mathcal{S}^{(0)}$  be a coarse-grained entropy that fixes all global charges, in our case the total energy and angular momentum. Because the first law of entanglement entropy is only sensitive to the change in the expectation value of the modular Hamiltonian, we have  $\delta\mathcal{S}^{(0)} = \delta\mathcal{S}^{(1)} = \delta S_W$ .

However, it is easy to see that  $\mathcal{S}^{(0)}$  is not equal to  $S_W$  beyond linear order. This is because  $\mathcal{S}^{(0)}$  is always equal to the Wald entropy of a stationary black hole with given energy and angular momentum, so for generic states the second law requires that  $S_W < \mathcal{S}^{(0)}$ . This implies that if there exists a coarse-grained entropy which is equal to  $S_W$  to all orders it would need to constrain more of the state than just the global charges. It was argued in [29] that  $\mathcal{S}^{(1)}$  is a natural candidate for such a coarse-grained entropy. See section 4.3 of [29] for a discussion of alternate proposals.

We conclude by discussing the relation of our results to the recent work of [228, 260, 261, 262]. Refs. [228, 260, 261] developed a formula for computing the area of closed bulk surfaces in terms of a quantity called the differential entropy. The differential entropy explicitly makes use of locally-extremal (but not necessarily minimal) surfaces. It was then argued in [262] that non-minimal extremal surfaces in  $\text{AdS}_{2+1}$  measure CFT ‘entanglement’, defined as the entanglement entropy between degrees of freedom which are not necessarily spatially localized. This interpretation refines the proposal of [228] that the differential entropy measures the information that is not accessible to a family of causal observers

in a finite amount of time.

The causal information surface  $C_{\mathcal{G}}$  (see Fig. 6.1), where  $\mathcal{G}$  is a boundary Cauchy surface of the geon spacetime mentioned above, provides an interesting setting for studying these proposals.<sup>10</sup> For this surface, the differential entropy takes a particularly simple form, it is given by the area of a single locally-extremal (but not minimal) surface. The one-point entropy can also be calculated exactly and agrees with the area of this surface (as predicted by the conjectured formula (6.2)).

Curiously, the same surface is singled out by both the differential entropy and  $\mathcal{S}^{(1)}$ , but for different reasons. The surface  $C_{\mathcal{G}}$  is a simple measure of entwinement because it is an extremal surface and it is conjectured to be a measure of the one-point entropy because it lies at the intersection of causal horizons. It would be interesting to understand how these measures of information are related as the spacetime is perturbed and the extremal and causal surfaces no longer coincide. Unfortunately, this difference does not show up in our linearized analysis precisely because the surface is extremal and therefore the area is not sensitive to the position of the surface at linear order. It seems that what is needed are more powerful methods of calculating  $\mathcal{S}^{(1)}$  both for testing (6.2) and for comparing  $\mathcal{S}^{(1)}$  with the differential entropy.

---

<sup>10</sup>More precisely we are interested in the limit as we approach  $C_{\mathcal{G}}$  from the black hole exterior. The quotient used to construct the  $\mathbb{RP}_n$  geon introduces an unphysical discontinuity in the area of spheres at  $C_{\mathcal{G}}$ , but the limit is well behaved.

# Chapter 7

## Conclusions

In this dissertation we have studied several implications of bulk causality for holographic field theories. After resolving a puzzle relating to deriving the Ryu–Takayanagi proposal in higher curvature theories of gravity in chapter 3, we showed in chapter 4 that boundary causality implies a quasilocal constraint on the CFT stress tensor in the form of the ANEC. In chapters 5 and 6 we studied the properties of causal wedges and a family of coarse grainings of the CFT state. We found that a natural candidate for the CFT dual of the causal holographic information  $\chi$  was given by the one-point entropy  $\mathcal{S}^{(1)}$ .

Each of these results opens several new questions that would be interesting to pursue in the future. The main result of chapter 3 is that there exists an analytic continuation of the replica manifold with the features needed to extend the Ryu–Takayanagi conjecture to perturbative Gauss–Bonnet gravity. It remains an open question whether this construction continues to hold non-perturbatively, and if it exists for more general gravitational theories. If so, it is still not yet clear if

there are any special features that distinguish this analytic continuation of the metric as the physically correct choice for computing the entanglement entropy. The hope of this line of research is that it will lead to an improved derivation of the Ryu–Takayanagi formula and possibly shed light on why the formula is true.

The proof of the ANEC in chapter 4 was restricted to Minkowski space, but there are generalizations of the ANEC (e.g. the achronal ANEC) which are believed to hold in curved spacetimes. By extending our arguments to more general spacetimes we might hope to learn more about how holographic theories are constrained by causality. Additionally, the proof of the ANEC only probes the asymptotic region of the spacetime, however boundary causality places restrictions on all bulk curves, even those that extend deep into the bulk. In the boundary theory these constraints involve complicated non-linear functions of the stress tensor. It would potentially be very interesting to develop a complete theory of these constraints and understand their significance for the CFT.

Finally, the results of chapter 5 and 6 leave many questions unanswered, however the path forward is clear. Using the reformulation of  $\mathcal{S}^{(1)} = \chi$  given in section A.3 below it will eventually be possible to prove or falsify this conjectured equality. Either way, understanding the way in which the local boundary data constrains the bulk spacetime will provide some new insight into how the CFT encodes bulk causality.

The ultimate hope of this program is that locating the features of the theory responsible for bulk causality will lead to a more complete understanding of how the Einstein equation (1.4) manages to hide inside the field theory defined by (1.5).

# Appendix A

## Coarse-grained entropy details

### A.1 $\chi$ -preserving coarse grainings

As mentioned in section 5.3.3, it is natural to ask if the restriction of (5.24) to states with classical coarse grainings can be dropped. In this appendix we show that the answer to this question is no.

Consider a coarse graining with the single constraint that  $\langle \hat{\chi} \rangle$  be held fixed, where  $\langle \hat{\chi} \rangle$  is some linear quantum expectation value which equals  $\chi$  for classical states. This coarse graining, which we call  $\mathcal{S}^{(\hat{\chi})}$ , cannot be the dual of  $\chi$ . Consider any Cauchy surface  $\mathcal{C}$  and state  $\rho_{\mathcal{C}}$  for which  $\chi_{\mathcal{C}} = 0$ . The entropy  $\mathcal{S}_{\mathcal{C}}^{(\hat{\chi})}(\rho_{\mathcal{C}})$  counts all states for which  $\chi_{\mathcal{C}} = 0$ . Because the volume of AdS is infinite, there are an infinite number of such states even at finite  $N$ . Therefore  $\mathcal{S}_{\mathcal{C}}^{(\hat{\chi})}(\rho_{\mathcal{C}})$  diverges (beyond the usual  $N^2$  divergence) in the correspondence limit.

$\mathcal{S}^{(\hat{\chi})}$  is therefore pathological since it assigns infinite entropy to a pure state. However, we can easily tame this divergence by adding a second constraint  $\langle \int T_{tt} \rangle$ ,

which for a Cauchy surface  $\mathcal{C}$  is simply the total energy  $E$  of the spacetime. Call this new coarse-grained entropy  $\mathcal{S}^{(\hat{\chi}, E)}$ . Now the state counting for  $\rho_{\mathcal{C}}$  includes all ways to collapse a black hole of a particular energy, including very slow collapses (e.g. the time reversal of Hawking evaporation for a sufficiently small black hole). This quantity is finite but still of order  $N^2$ , which implies

$$\mathcal{S}_{\mathcal{C}}^{(\hat{\chi}, E)}(\rho_{\mathcal{C}}) > \chi_{\mathcal{C}}. \quad (\text{A.1})$$

We have not violated the inequality (5.24) because (5.24) only holds when the coarse-grained state  $\sigma_{\mathcal{C}}$  is classical. However, all of the classical states satisfying the constraints of  $\mathcal{S}^{(\hat{\chi}, E)}$  have the same (vanishing) von Neumann entropy (since  $S_{\mathcal{C}} \leq \chi_{\mathcal{C}} = 0$  for all such classical geometries). Hence the coarse graining  $\sigma_{\mathcal{C}}$  is a mixture of an infinite number of classically distinguishable states, and therefore it is non-classical.

## A.2 Boundary sources

As mentioned above, we only conjecture that  $\chi$  is dual to a coarse-grained entropy for theories with time-independent Hamiltonians (i.e. in the absence of boundary sources). We now explain the reason for this restriction.

Let  $\mathcal{S}$  be any coarse graining and let  $\rho_{\mathcal{A}}$  be any state which satisfies the conditions of (L1) so that  $\mathcal{S}_{\mathcal{A}}(\rho_{\mathcal{A}}) = S_{\mathcal{A}}(\rho_{\mathcal{A}})$ . An important feature of (L1) is that nothing is assumed about the time evolution of  $\rho_{\mathcal{A}}$  within  $D[\mathcal{A}]$ , except that it is unitary. It therefore applies even if we insert boundary sources, which can potentially increase  $\chi_{\mathcal{A}}$ .

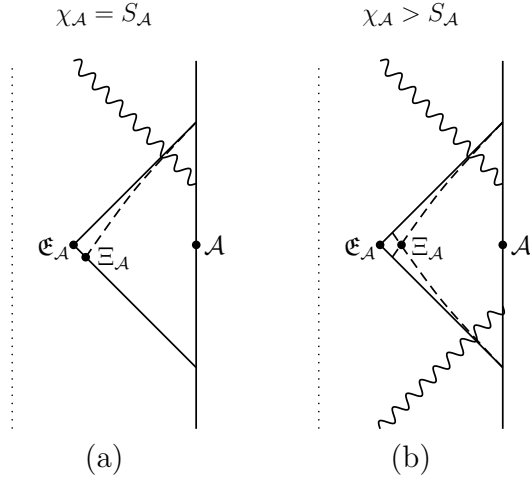

Figure A.1: Various insertions of sources on the vacuum AdS boundary. In each figure the solid line to the right represents the AdS boundary and  $\mathcal{A}$  is a spherical region. (a) By causality  $\mathfrak{E}_{\mathcal{A}}$  is unperturbed by the sources however  $\Xi_{\mathcal{A}}$  is moved due to focusing of light rays (shown schematically by the dashed lines). However this focusing does not change  $\chi$  since the past horizon has vanishing expansion. (b) An ingoing and outgoing source which gives  $\chi_{\mathcal{A}} > S_{\mathcal{A}} = \mathcal{S}_{\mathcal{A}}^{(1)}$ .

This would lead to a contradiction in situations where  $H \in \{\mathcal{O}_m\}$ , since we can always add or remove boundary sources to achieve  $\mathcal{S}_{\mathcal{A}}(\rho_{\mathcal{A}}) < \chi_{\mathcal{A}}(\rho_{\mathcal{A}})$  (see Fig. A.1).

This includes the case in which  $\mathcal{A}$  is a Cauchy surface and the bulk geometry is a stationary black hole. In this case the modular Hamiltonian is a linear combination of energy, angular momentum, gauge charges, etc. It is hard to imagine a  $\chi$ -preserving coarse graining which does not constrain any of these quantities, and yet which does not suffer from the same problems as  $\mathcal{S}^{(\hat{\chi}, E)}$  (see appendix A.1). For this reason we will restrict our attention to theories without any boundary sources turned on.

### A.3 Testing $\mathcal{S}^{(1)} = \chi$

In this appendix we propose a testable conjecture about the Einstein equation which, if true, could provide substantial evidence for (6.2). Attempts to carry out these tests are ongoing and will be reported separately.

Let  $s$  be a smooth, asymptotically locally AdS solution to the vacuum Einstein equation. Let  $g_{\mu\nu}, T^{\mu\nu}$  be the boundary metric and stress tensor of  $s$  and let  $\mathcal{A}$  be some spacelike region on the boundary. Now let  $\mathcal{S}$  be the set of all smooth asymptotically AdS solutions  $\tilde{s}$  with boundary data  $\tilde{g}_{\mu\nu}, \tilde{T}^{\mu\nu}$  such there exists a region  $\tilde{\mathcal{A}}$  on the boundary of  $\tilde{s}$  which satisfies

$$g_{\mu\nu}(x) = \tilde{g}_{\mu\nu}(x), \quad T^{\mu\nu}(x) = \tilde{T}^{\mu\nu}(x), \quad x \in D[\tilde{\mathcal{A}}]. \quad (\text{A.2})$$

These classical solutions  $\mathcal{S}$  capture some subset of the quantum states  $S_{\mathcal{A}} \subset T_{\mathcal{A}}$  over which we would like to maximize the von Neumann entropy in order to evaluate (5.25).

Now we introduce a new assumption. Say that,

$$\text{lub}_{\tau_{\mathcal{A}} \in T_{\mathcal{A}}} S(\tau_{\mathcal{A}}) = \text{lub}_{\sigma_{\mathcal{A}} \in S_{\mathcal{A}}} S(\sigma_{\mathcal{A}}). \quad (\text{A.3})$$

If this assumption holds we may calculate  $\mathcal{S}^{(1)}$  by considering classical geometries only, and maximizing the entropy reduces to maximizing the area of the extremal surface  $E_{\mathcal{A}}$  (see Fig. 6.1) over geometries in  $\mathcal{S}$ . It should be noted that (A.3) holds whenever we have to date been able to calculate  $\mathcal{S}^{(1)}$  (including the perturbative results established in section 6.3).



Assuming (A.3), then the conjecture (6.2) makes two predictions about  $\mathcal{S}$ :

- every solution  $\tilde{s} \in \mathcal{S}$  should satisfy  $\text{Area}[C_{\mathcal{A}}(\tilde{s})] = \text{Area}[C_{\mathcal{A}}(s)]$  , and
- $\text{Area}[C_{\mathcal{A}}(s)] = \text{lub}_{\tilde{s} \in \mathcal{S}} \text{Area}[E_{\mathcal{A}}(\tilde{s})]$ .

The first claim follows from the fact that (6.2) implies that  $\chi_{\mathcal{A}}$  is a function only of the boundary data in  $D[\mathcal{A}]$  which is being held fixed by (A.2). The second claim is simply a combination of our assumption (A.3) and (6.2). We should note that if the first claim  $\text{Area}[C_{\mathcal{A}}(\tilde{s})] = \text{Area}[C_{\mathcal{A}}(s)]$  is true, then it follows from existing results [25, 195] that  $\text{Area}[C_{\mathcal{A}}(s)]$  is an upper bound on  $\text{Area}[E_{\mathcal{A}}(\tilde{s})]$  (but not that it is the least upper bound).

These conjectures, even if they are difficult to prove in any generality, can in principle be tested by constructing solutions numerically. Such tests have the potential to provide strong evidence for (or to conclusively falsify) (6.2).

# Bibliography

- [1] J. M. Maldacena, *The Large  $N$  limit of superconformal field theories and supergravity*, *Adv.Theor.Math.Phys.* **2** (1998) 231–252, [hep-th/9711200].
- [2] S. Gubser, I. R. Klebanov, and A. M. Polyakov, *Gauge theory correlators from noncritical string theory*, *Phys.Lett.* **B428** (1998) 105–114, [hep-th/9802109].
- [3] E. Witten, *Anti-de Sitter space and holography*, *Adv.Theor.Math.Phys.* **2** (1998) 253–291, [hep-th/9802150].
- [4] O. Aharony, S. S. Gubser, J. M. Maldacena, H. Ooguri, and Y. Oz, *Large  $N$  field theories, string theory and gravity*, *Phys.Rept.* **323** (2000) 183–386, [hep-th/9905111].
- [5] E. D’Hoker and D. Z. Freedman, *Supersymmetric gauge theories and the AdS / CFT correspondence*, hep-th/0201253.
- [6] G. T. Horowitz and J. Polchinski, *Gauge/gravity duality*, gr-qc/0602037.
- [7] J. Polchinski, *Introduction to Gauge/Gravity Duality*, arXiv:1010.6134.
- [8] J. Maldacena, *The Gauge/gravity duality*, arXiv:1106.6073.
- [9] V. E. Hubeny, *The AdS/CFT Correspondence*, arXiv:1501.0000.
- [10] G. ’t Hooft, *A Planar Diagram Theory for Strong Interactions*, *Nucl.Phys.* **B72** (1974) 461.
- [11] V. Balasubramanian, P. Kraus, and A. E. Lawrence, *Bulk versus boundary dynamics in anti-de Sitter space-time*, *Phys.Rev.* **D59** (1999) 046003, [hep-th/9805171].
- [12] V. Balasubramanian, P. Kraus, A. E. Lawrence, and S. P. Trivedi, *Holographic probes of anti-de Sitter space-times*, *Phys.Rev.* **D59** (1999) 104021, [hep-th/9808017].

- [13] T. Banks, M. R. Douglas, G. T. Horowitz, and E. J. Martinec, *AdS dynamics from conformal field theory*, hep-th/9808016.
- [14] I. Bena, *On the construction of local fields in the bulk of AdS(5) and other spaces*, *Phys.Rev.* **D62** (2000) 066007, [hep-th/9905186].
- [15] A. Hamilton, D. N. Kabat, G. Lifschytz, and D. A. Lowe, *Local bulk operators in AdS/CFT: A Boundary view of horizons and locality*, *Phys.Rev.* **D73** (2006) 086003, [hep-th/0506118].
- [16] A. Hamilton, D. N. Kabat, G. Lifschytz, and D. A. Lowe, *Holographic representation of local bulk operators*, *Phys.Rev.* **D74** (2006) 066009, [hep-th/0606141].
- [17] D. Kabat, G. Lifschytz, and D. A. Lowe, *Constructing local bulk observables in interacting AdS/CFT*, *Phys.Rev.* **D83** (2011) 106009, [arXiv:1102.2910].
- [18] I. Heemskerk, D. Marolf, J. Polchinski, and J. Sully, *Bulk and Transhorizon Measurements in AdS/CFT*, *JHEP* **1210** (2012) 165, [arXiv:1201.3664].
- [19] S. Ryu and T. Takayanagi, *Holographic derivation of entanglement entropy from AdS/CFT*, *Phys.Rev.Lett.* **96** (2006) 181602, [hep-th/0603001].
- [20] S. Ryu and T. Takayanagi, *Aspects of Holographic Entanglement Entropy*, *JHEP* **0608** (2006) 045, [hep-th/0605073].
- [21] A. Lewkowycz and J. Maldacena, *Generalized gravitational entropy*, *JHEP* **1308** (2013) 090, [arXiv:1304.4926].
- [22] N. Lashkari, M. B. McDermott, and M. Van Raamsdonk, *Gravitational dynamics from entanglement 'thermodynamics'*, *JHEP* **1404** (2014) 195, [arXiv:1308.3716].
- [23] T. Faulkner, M. Guica, T. Hartman, R. C. Myers, and M. Van Raamsdonk, *Gravitation from Entanglement in Holographic CFTs*, *JHEP* **1403** (2014) 051, [arXiv:1312.7856].
- [24] B. Swingle and M. Van Raamsdonk, *Universality of Gravity from Entanglement*, arXiv:1405.2933.
- [25] V. E. Hubeny and M. Rangamani, *Causal Holographic Information*, *JHEP* **1206** (2012) 114, [arXiv:1204.1698].

- [26] S. Fischetti, W. Kelly, and D. Marolf, *Conserved Charges in Asymptotically (Locally) AdS Spacetimes*, arXiv:1211.6347.
- [27] J. Camps and W. R. Kelly, *Generalized gravitational entropy without replica symmetry*, *JHEP* **1503** (2015) 061, [arXiv:1412.4093].
- [28] W. R. Kelly and A. C. Wall, *A holographic proof of the averaged null energy condition*, *Phys.Rev.* **D90** (2014) 106003, [arXiv:1408.3566].
- [29] W. R. Kelly and A. C. Wall, *Coarse-grained entropy and causal holographic information in AdS/CFT*, *JHEP* **1403** (2014) 118, [arXiv:1309.3610].
- [30] W. R. Kelly, *Deriving the First Law of Black Hole Thermodynamics without Entanglement*, *JHEP* **1410** (2014) 192, [arXiv:1408.3705].
- [31] G. T. Horowitz and V. E. Hubeny, *CFT description of small objects in AdS*, *JHEP* **0010** (2000) 027, [hep-th/0009051].
- [32] L. Abbott and S. Deser, *Stability of Gravity with a Cosmological Constant*, *Nucl.Phys.* **B195** (1982) 76.
- [33] M. Henneaux and C. Teitelboim, *Hamiltonian Treatment of Asymptotically anti-de Sitter Spaces*, *Phys.Lett.* **B142** (1984) 355–358.
- [34] M. Henneaux and C. Teitelboim, *Asymptotically anti-De Sitter Spaces*, *Commun.Math.Phys.* **98** (1985) 391–424.
- [35] J. D. Brown and M. Henneaux, *Central Charges in the Canonical Realization of Asymptotic Symmetries: An Example from Three-Dimensional Gravity*, *Commun.Math.Phys.* **104** (1986) 207–226.
- [36] I. Papadimitriou and K. Skenderis, *Thermodynamics of asymptotically locally AdS spacetimes*, *JHEP* **0508** (2005) 004, [hep-th/0505190].
- [37] S. Hollands, A. Ishibashi, and D. Marolf, *Counter-term charges generate bulk symmetries*, *Phys.Rev.* **D72** (2005) 104025, [hep-th/0503105].
- [38] T. Andrade and D. Marolf, *AdS/CFT beyond the unitarity bound*, *JHEP* **1201** (2012) 049, [arXiv:1105.6337].
- [39] R. M. Wald, *General Relativity*. University Of Chicago Press, 1st ed., June, 1984.
- [40] A. Ashtekar and A. Magnon, *Asymptotically anti-de Sitter space-times*, *Class.Quant.Grav.* **1** (1984) L39–L44.

- [41] A. Ashtekar and S. Das, *Asymptotically Anti-de Sitter space-times: Conserved quantities*, *Class.Quant.Grav.* **17** (2000) L17–L30, [hep-th/9911230].
- [42] M. C. Cheng and K. Skenderis, *Positivity of energy for asymptotically locally AdS spacetimes*, *JHEP* **0508** (2005) 107, [hep-th/0506123].
- [43] K. Skenderis, *Asymptotically Anti-de Sitter space-times and their stress energy tensor*, *Int.J.Mod.Phys.* **A16** (2001) 740–749, [hep-th/0010138].
- [44] K. Skenderis, *Lecture notes on holographic renormalization*, *Class.Quant.Grav.* **19** (2002) 5849–5876, [hep-th/0209067].
- [45] S. de Haro, S. N. Solodukhin, and K. Skenderis, *Holographic reconstruction of space-time and renormalization in the AdS / CFT correspondence*, *Commun.Math.Phys.* **217** (2001) 595–622, [hep-th/0002230].
- [46] R. Penrose and W. Rindler, *Spinors and Space-Time*, vol. 2. Cambridge University Press, 1984.
- [47] C. Fefferman and C. R. Graham, *Conformal invariants*, in *Elie Cartan et les Mathématiques d’aujourd’hui*, Astérisque, p. 95, 1985.
- [48] K. Skenderis and S. N. Solodukhin, *Quantum effective action from the AdS / CFT correspondence*, *Phys.Lett.* **B472** (2000) 316–322, [hep-th/9910023].
- [49] P. Breitenlohner and D. Z. Freedman, *Positive energy in anti-de sitter backgrounds and gauged extended supergravity*, *Physics Letters B* **115** (1982), no. 3 197 – 201.
- [50] J. D. Brown and J. York, James W., *Quasilocal energy and conserved charges derived from the gravitational action*, *Phys.Rev.* **D47** (1993) 1407–1419, [gr-qc/9209012].
- [51] S. Hawking, *The path-integral approach to quantum gravity*, in *General Relativity: An Einstein Centenary Survey* (S. Hawking and W. Israel, eds.), vol. 1, pp. 746–789. Cambridge University Press, Cambridge; New York, 1979.
- [52] M. Henningson and K. Skenderis, *The Holographic Weyl anomaly*, *JHEP* **9807** (1998) 023, [hep-th/9806087].
- [53] V. Balasubramanian and P. Kraus, *A Stress tensor for Anti-de Sitter gravity*, *Commun.Math.Phys.* **208** (1999) 413–428, [hep-th/9902121].

- [54] G. Compere and D. Marolf, *Setting the boundary free in AdS/CFT*, *Class.Quant.Grav.* **25** (2008) 195014, [arXiv:0805.1902].
- [55] E. Witten, *A Simple Proof of the Positive Energy Theorem*, *Commun.Math.Phys.* **80** (1981) 381.
- [56] J. A. Nester, *A New gravitational energy expression with a simple positivity proof*, *Phys.Lett.* **A83** (1981) 241.
- [57] P. Townsend, *Positive energy and the scalar potential in higher dimensional (super)gravity theories*, *Phys.Lett.* **B148** (1984) 55.
- [58] T. Hertog and S. Hollands, *Stability in designer gravity*, *Class.Quant.Grav.* **22** (2005) 5323–5342, [hep-th/0508181].
- [59] A. J. Amsel and D. Marolf, *Energy Bounds in Designer Gravity*, *Phys.Rev.* **D74** (2006) 064006, [hep-th/0605101].
- [60] A. J. Amsel, T. Hertog, S. Hollands, and D. Marolf, *A Tale of two superpotentials: Stability and instability in designer gravity*, *Phys.Rev.* **D75** (2007) 084008, [hep-th/0701038].
- [61] T. Faulkner, G. T. Horowitz, and M. M. Roberts, *New stability results for Einstein scalar gravity*, *Class.Quant.Grav.* **27** (2010) 205007, [arXiv:1006.2387].
- [62] A. J. Amsel and M. M. Roberts, *Stability in Einstein-Scalar Gravity with a Logarithmic Branch*, *Phys.Rev.* **D85** (2012) 106011, [arXiv:1112.3964].
- [63] T. Hertog, *Violation of Energy Bounds in Designer Gravity*, *Class.Quant.Grav.* **24** (2007) 141–154, [hep-th/0607171].
- [64] S. Deser and C. Teitelboim, *Supergravity Has Positive Energy*, *Phys.Rev.Lett.* **39** (1977) 249.
- [65] M. T. Grisaru, *Positivity of the Energy in Einstein Theory*, *Phys.Lett.* **B73** (1978) 207.
- [66] G. T. Horowitz and R. C. Myers, *The AdS / CFT correspondence and a new positive energy conjecture for general relativity*, *Phys.Rev.* **D59** (1998) 026005, [hep-th/9808079].
- [67] E. Witten, *Instability of the Kaluza-Klein Vacuum*, *Nucl.Phys.* **B195** (1982) 481.

- [68] D. Brill and H. Pfister, *STATES OF NEGATIVE TOTAL ENERGY IN KALUZA-KLEIN THEORY*, *Phys.Lett.* **B228** (1989) 359–362.
- [69] E. Witten, *Anti-de Sitter space, thermal phase transition, and confinement in gauge theories*, *Adv.Theor.Math.Phys.* **2** (1998) 505–532, [hep-th/9803131].
- [70] S. Hollands, A. Ishibashi, and D. Marolf, *Comparison between various notions of conserved charges in asymptotically AdS-spacetimes*, *Class.Quant.Grav.* **22** (2005) 2881–2920, [hep-th/0503045].
- [71] R. E. Peierls, *The commutation laws of relativistic field theory*, *Proc. Roy. Soc. (London)* **214** (1952) 143.
- [72] B. S. DeWitt, *Dynamical Theory of Groups and Fields*. Gordon and Breach, 1965.
- [73] B. S. DeWitt, *The spacetime approach to quantum field theory*, in *Relativity, Groups, and Topology II: Les Houches, part 2* (B. S. Dewitt and R. Stora, eds.), p. 381. North-Holland, 1984.
- [74] D. M. Marolf, *The Generalized Peierls bracket*, *Annals Phys.* **236** (1994) 392–412, [hep-th/9308150].
- [75] R. D. Sorkin, *Conserved Quantities as Action Variations*, .
- [76] M. Banados, C. Teitelboim, and J. Zanelli, *The Black hole in three-dimensional space-time*, *Phys.Rev.Lett.* **69** (1992) 1849–1851, [hep-th/9204099].
- [77] M. Banados, M. Henneaux, C. Teitelboim, and J. Zanelli, *Geometry of the (2+1) black hole*, *Phys.Rev.* **D48** (1993) 1506–1525, [gr-qc/9302012].
- [78] R. B. Mann and D. Marolf, *Holographic renormalization of asymptotically flat spacetimes*, *Class.Quant.Grav.* **23** (2006) 2927–2950, [hep-th/0511096].
- [79] R. B. Mann, D. Marolf, and A. Virmani, *Covariant Counterterms and Conserved Charges in Asymptotically Flat Spacetimes*, *Class.Quant.Grav.* **23** (2006) 6357–6378, [gr-qc/0607041].
- [80] R. B. Mann, D. Marolf, R. McNees, and A. Virmani, *On the Stress Tensor for Asymptotically Flat Gravity*, *Class.Quant.Grav.* **25** (2008) 225019, [arXiv:0804.2079].

- [81] G. Gibbons, S. Hawking, G. T. Horowitz, and M. J. Perry, *Positive Mass Theorems for Black Holes*, *Commun.Math.Phys.* **88** (1983) 295.
- [82] G. Gibbons, C. Hull, and N. Warner, *The Stability of Gauged Supergravity*, *Nucl.Phys.* **B218** (1983) 173.
- [83] J. Katz, J. Bicak, and D. Lynden-Bell, *Relativistic conservation laws and integral constraints for large cosmological perturbations*, *Phys.Rev.* **D55** (1997) 5957–5969, [gr-qc/0504041].
- [84] N. Deruelle and J. Katz, *On the mass of a Kerr-anti-de Sitter spacetime in  $D$  dimensions*, *Class.Quant.Grav.* **22** (2005) 421–424, [gr-qc/0410135].
- [85] S. Bhattacharyya, V. E. Hubeny, S. Minwalla, and M. Rangamani, *Nonlinear Fluid Dynamics from Gravity*, *JHEP* **0802** (2008) 045, [arXiv:0712.2456].
- [86] E. Thorne, Kip S., E. Price, R.H., and E. Macdonald, D.A., *Black Holes: The Membrane Paradigm*, .
- [87] E. Witten, *Multitrace operators, boundary conditions, and AdS / CFT correspondence*, hep-th/0112258.
- [88] S. S. Gubser and I. Mitra, *Double trace operators and one loop vacuum energy in AdS / CFT*, *Phys.Rev.* **D67** (2003) 064018, [hep-th/0210093].
- [89] E. Witten,  *$SL(2,Z)$  action on three-dimensional conformal field theories with Abelian symmetry*, hep-th/0307041.
- [90] D. Marolf, *Unitarity and Holography in Gravitational Physics*, *Phys.Rev.* **D79** (2009) 044010, [arXiv:0808.2842].
- [91] S. Gao and R. M. Wald, *Theorems on gravitational time delay and related issues*, *Class.Quant.Grav.* **17** (2000) 4999–5008, [gr-qc/0007021].
- [92] D. Marolf, *Holographic Thought Experiments*, *Phys.Rev.* **D79** (2009) 024029, [arXiv:0808.2845].
- [93] D. Marolf, *Black Holes, AdS, and CFTs*, *Gen.Rel.Grav.* **41** (2009) 903–917, [arXiv:0810.4886].
- [94] D. Marolf and A. C. Wall, *Eternal Black Holes and Superselection in AdS/CFT*, arXiv:1210.3590.



- [95] J. D. Bekenstein, *Black holes and entropy*, *Phys.Rev.* **D7** (1973) 2333–2346.
- [96] J. M. Bardeen, B. Carter, and S. Hawking, *The Four laws of black hole mechanics*, *Commun.Math.Phys.* **31** (1973) 161–170.
- [97] S. Hawking, *Particle Creation by Black Holes*, *Commun.Math.Phys.* **43** (1975) 199–220.
- [98] G. Gibbons and S. Hawking, *Action Integrals and Partition Functions in Quantum Gravity*, *Phys.Rev.* **D15** (1977) 2752–2756.
- [99] M. Headrick and T. Takayanagi, *A Holographic proof of the strong subadditivity of entanglement entropy*, *Phys.Rev.* **D76** (2007) 106013, [arXiv:0704.3719].
- [100] D. V. Fursaev, *Proof of the holographic formula for entanglement entropy*, *JHEP* **0609** (2006) 018, [hep-th/0606184].
- [101] H. Casini, M. Huerta, and R. C. Myers, *Towards a derivation of holographic entanglement entropy*, *JHEP* **1105** (2011) 036, [arXiv:1102.0440].
- [102] D. V. Fursaev, A. Patrushev, and S. N. Solodukhin, *Distributional Geometry of Squashed Cones*, *Phys.Rev.* **D88** (2013), no. 4 044054, [arXiv:1306.4000].
- [103] X. Dong, *Holographic Entanglement Entropy for General Higher Derivative Gravity*, *JHEP* **1401** (2014) 044, [arXiv:1310.5713].
- [104] J. Camps, *Generalized entropy and higher derivative Gravity*, *JHEP* **1403** (2014) 070, [arXiv:1310.6659].
- [105] R.-X. Miao and W.-z. Guo, *Holographic Entanglement Entropy for the Most General Higher Derivative Gravity*, arXiv:1411.5579.
- [106] A. Bhattacharyya, A. Kaviraj, and A. Sinha, *Entanglement entropy in higher derivative holography*, *JHEP* **1308** (2013) 012, [arXiv:1305.6694].
- [107] B. Chen and J.-j. Zhang, *Note on generalized gravitational entropy in Lovelock gravity*, *JHEP* **1307** (2013) 185, [arXiv:1305.6767].
- [108] A. Bhattacharyya, M. Sharma, and A. Sinha, *On generalized gravitational entropy, squashed cones and holography*, *JHEP* **1401** (2014) 021, [arXiv:1308.5748].

- [109] A. Bhattacharyya and M. Sharma, *On entanglement entropy functionals in higher derivative gravity theories*, arXiv:1405.3511.
- [110] C. Lanczos, *A Remarkable property of the Riemann-Christoffel tensor in four dimensions*, *Annals Math.* **39** (1938) 842–850.
- [111] D. Lovelock, *The Einstein tensor and its generalizations*, *J.Math.Phys.* **12** (1971) 498–501.
- [112] B. Zwiebach, *Curvature Squared Terms and String Theories*, *Phys.Lett.* **B156** (1985) 315.
- [113] J. Erdmenger, M. Flory, and C. Sleight, *Conditions on holographic entangling surfaces in higher curvature gravity*, *JHEP* **1406** (2014) 104, [arXiv:1401.5075].
- [114] H. Reall, N. Tanahashi, and B. Way, *Causality and Hyperbolicity of Lovelock Theories*, arXiv:1406.3379.
- [115] X. O. Camanho, J. D. Edelstein, J. Maldacena, and A. Zhiboedov, *Causality Constraints on Corrections to the Graviton Three-Point Coupling*, arXiv:1407.5597.
- [116] H. S. Reall, N. Tanahashi, and B. Way, *Shock Formation in Lovelock Theories*, arXiv:1409.3874.
- [117] J. de Boer, M. Kulaxizi, and A. Parnachev, *Holographic Entanglement Entropy in Lovelock Gravities*, *JHEP* **1107** (2011) 109, [arXiv:1101.5781].
- [118] L.-Y. Hung, R. C. Myers, and M. Smolkin, *On Holographic Entanglement Entropy and Higher Curvature Gravity*, *JHEP* **1104** (2011) 025, [arXiv:1101.5813].
- [119] T. Jacobson, G. Kang, and R. C. Myers, *On black hole entropy*, *Phys.Rev.* **D49** (1994) 6587–6598, [gr-qc/9312023].
- [120] T. Jacobson and R. C. Myers, *Black hole entropy and higher curvature interactions*, *Phys.Rev.Lett.* **70** (1993) 3684–3687, [hep-th/9305016].
- [121] A. Prudenziati, *A perturbative study on the analytic continuation for generalized gravitational entropy*, arXiv:1412.1037.
- [122] T. Faulkner, *The Entanglement Renyi Entropies of Disjoint Intervals in AdS/CFT*, arXiv:1303.7221.

- [123] A. Belin, A. Maloney, and S. Matsuura, *Holographic Phases of Renyi Entropies*, *JHEP* **1312** (2013) 050, [arXiv:1306.2640].
- [124] R. Emparan, *AdS / CFT duals of topological black holes and the entropy of zero energy states*, *JHEP* **9906** (1999) 036, [hep-th/9906040].
- [125] F. Denef, *TASI lectures on complex structures*, arXiv:1104.0254.
- [126] D. Anninos, T. Anous, J. Barandes, F. Denef, and B. Gaasbeek, *Hot Halos and Galactic Glasses*, *JHEP* **1201** (2012) 003, [arXiv:1108.5821].
- [127] D. Anninos and F. Denef, *Cosmic Clustering*, arXiv:1111.6061.
- [128] D. Anninos, T. Anous, F. Denef, G. Konstantinidis, and E. Shaghoulian, *Supergoop Dynamics*, *JHEP* **1303** (2013) 081, [arXiv:1205.1060].
- [129] D. Anninos, T. Anous, F. Denef, and L. Peeters, *Holographic Vitrification*, arXiv:1309.0146.
- [130] A. Adams and S. Yaida, *Disordered Holographic Systems I: Functional Renormalization*, arXiv:1102.2892.
- [131] A. Adams and S. Yaida, *Disordered holographic systems: Marginal relevance of imperfection*, *Phys.Rev.* **D90** (2014), no. 4 046007, [arXiv:1201.6366].
- [132] D. Arean, A. Farahi, L. A. Pando Zayas, I. S. Landea, and A. Scardicchio, *A Dirty Holographic Superconductor*, *Phys.Rev.* **D89** (2014) 106003, [arXiv:1308.1920].
- [133] S. A. Hartnoll and J. E. Santos, *Disordered horizons: Holography of randomly disordered fixed points*, *Phys.Rev.Lett.* **112** (2014) 231601, [arXiv:1402.0872].
- [134] H. Epstein, V. Glaser, and A. Jaffe, *Nonpositivity of energy density in Quantized field theories*, *Nuovo Cim.* **36** (1965) 1016.
- [135] M. Morris, K. Thorne, and U. Yurtsever, *Wormholes, Time Machines, and the Weak Energy Condition*, *Phys.Rev.Lett.* **61** (1988) 1446–1449.
- [136] A. Ori, *Must time machine construction violate the weak energy condition?*, *Phys.Rev.Lett.* **71** (1993) 2517–2520.
- [137] L. Ford and T. A. Roman, *Quantum field theory constrains traversable wormhole geometries*, *Phys.Rev.* **D53** (1996) 5496–5507, [gr-qc/9510071].

- [138] D. Hochberg and M. Visser, *The Null energy condition in dynamic wormholes*, *Phys.Rev.Lett.* **81** (1998) 746–749, [gr-qc/9802048].
- [139] M. Visser, S. Kar, and N. Dadhich, *Traversable wormholes with arbitrarily small energy condition violations*, *Phys.Rev.Lett.* **90** (2003) 201102, [gr-qc/0301003].
- [140] M. Alcubierre, *The Warp drive: Hyperfast travel within general relativity*, *Class.Quant.Grav.* **11** (1994) L73–L77, [gr-qc/0009013].
- [141] J. Natario, *Warp drive with zero expansion*, *Class.Quant.Grav.* **19** (2002) 1157–1166, [gr-qc/0110086].
- [142] R. Penrose, *Gravitational collapse and space-time singularities*, *Phys.Rev.Lett.* **14** (1965) 57–59.
- [143] S. Hawking, *The Occurrence of singularities in cosmology*, *Proc.Roy.Soc.Lond.* **A294** (1966) 511–521.
- [144] S. Hawking and R. Penrose, *The Singularities of gravitational collapse and cosmology*, *Proc.Roy.Soc.Lond.* **A314** (1970) 529–548.
- [145] A. Borde, *Geodesic focusing, energy conditions and singularities*, *Class.Quant.Grav.* **4** (1987) 343–356.
- [146] S. W. Hawking and G. F. R. Ellis, *The Large Scale Structure of Space-Time*. Cambridge University Press, 1975.
- [147] F. J. Tipler, *Energy conditions and spacetime singularities*, *Phys.Rev.* **D17** (1978) 2521–2528.
- [148] R. Penrose, R. Sorkin, and E. Woolgar, *A Positive mass theorem based on the focusing and retardation of null geodesics*, gr-qc/9301015.
- [149] J. L. Friedman, K. Schleich, and D. M. Witt, *Topological censorship*, *Phys.Rev.Lett.* **71** (1993) 1486–1489, [gr-qc/9305017].
- [150] T. Roman, *Quantum Stress Energy Tensors and the Weak Energy Condition*, *Phys.Rev.* **D33** (1986) 3526–3533.
- [151] T. Roman, *On the ‘Averaged Weak Energy Condition’ and Penrose’s Singularity Theorem*, *Phys.Rev.* **D37** (1988) 546–548.
- [152] C. J. Fewster and G. J. Galloway, *Singularity theorems from weakened energy conditions*, *Class.Quant.Grav.* **28** (2011) 125009, [arXiv:1012.6038].

- [153] C. J. Fewster, *Lectures on quantum energy inequalities*, arXiv:1208.5399.
- [154] E. Curiel, *A Primer on Energy Conditions*, arXiv:1405.0403.
- [155] G. Klinkhammer, *Averaged energy conditions for free scalar fields in flat space-times*, *Phys.Rev.* **D43** (1991) 2542–2548.
- [156] L. Ford and T. A. Roman, *Averaged energy conditions and quantum inequalities*, *Phys.Rev.* **D51** (1995) 4277–4286, [gr-qc/9410043].
- [157] A. Folacci, *Averaged null energy condition for electromagnetism in Minkowski space-time*, *Phys.Rev.* **D46** (1992) 2726–2729.
- [158] R. Verch, *The Averaged Null energy condition for general quantum field theories in two-dimensions*, *J.Math.Phys.* **41** (2000) 206–217, [math-ph/9904036].
- [159] A. C. Wall, *A proof of the generalized second law for rapidly changing fields and arbitrary horizon slices*, *Phys.Rev.* **D85** (2012), no. 6 104049, [arXiv:1105.3445].
- [160] U. Yurtsever, *Does quantum field theory enforce the averaged weak energy condition?*, *Class.Quant.Grav.* **7** (1990) L251–L258.
- [161] R. M. Wald and U. Yurtsever, *General proof of the averaged null energy condition for a massless scalar field in two-dimensional curved space-time*, *Phys.Rev.* **D44** (1991) 403–416.
- [162] U. Yurtsever, *The Averaged null energy condition and difference inequalities in quantum field theory*, *Phys.Rev.* **D51** (1995) 5797–5805, [gr-qc/9411056].
- [163] C. J. Fewster and T. A. Roman, *Null energy conditions in quantum field theory*, *Phys.Rev.* **D67** (2003) 044003, [gr-qc/0209036].
- [164] N. Graham and K. D. Olum, *Plate with a hole obeys the averaged null energy condition*, *Phys.Rev.* **D72** (2005) 025013, [hep-th/0506136].
- [165] C. J. Fewster, K. D. Olum, and M. J. Pfenning, *Averaged null energy condition in spacetimes with boundaries*, *Phys.Rev.* **D75** (2007) 025007, [gr-qc/0609007].
- [166] H. Bostelmann and C. J. Fewster, *Quantum Inequalities from Operator Product Expansions*, *Commun.Math.Phys.* **292** (2009) 761–795, [arXiv:0812.4760].

- [167] D. D. Blanco and H. Casini, *Localization of Negative Energy and the Bekenstein Bound*, *Phys.Rev.Lett.* **111** (2013), no. 22 221601, [arXiv:1309.1121].
- [168] M. Visser, *Gravitational vacuum polarization. 2: Energy conditions in the Boulware vacuum*, *Phys.Rev.* **D54** (1996) 5116–5122, [gr-qc/9604008].
- [169] D. Urban and K. D. Olum, *Spacetime Averaged Null Energy Condition*, *Phys.Rev.* **D81** (2010) 124004, [arXiv:1002.4689].
- [170] D. Urban and K. D. Olum, *Averaged null energy condition violation in a conformally flat spacetime*, *Phys.Rev.* **D81** (2010) 024039, [arXiv:0910.5925].
- [171] N. Graham and K. D. Olum, *Achronal averaged null energy condition*, *Phys.Rev.* **D76** (2007) 064001, [arXiv:0705.3193].
- [172] E. E. Flanagan and R. M. Wald, *Does back reaction enforce the averaged null energy condition in semiclassical gravity?*, *Phys.Rev.* **D54** (1996) 6233–6283, [gr-qc/9602052].
- [173] E. Minguzzi, *Chronological spacetimes without lightlike lines are stably causal*, *Commun.Math.Phys.* **288** (2009) 801–819, [arXiv:0806.0153].
- [174] E.-A. Kontou and K. D. Olum, *Averaged null energy condition in a classical curved background*, *Phys.Rev.* **D87** (2013), no. 6 064009, [arXiv:1212.2290].
- [175] A. C. Wall, *Proving the Achronal Averaged Null Energy Condition from the Generalized Second Law*, *Phys.Rev.* **D81** (2010) 024038, [arXiv:0910.5751].
- [176] I. Heemskerk, J. Penedones, J. Polchinski, and J. Sully, *Holography from Conformal Field Theory*, *JHEP* **0910** (2009) 079, [arXiv:0907.0151].
- [177] D. N. Page, S. Surya, and E. Woolgar, *Positive mass from holographic causality*, *Phys.Rev.Lett.* **89** (2002) 121301, [hep-th/0204198].
- [178] E. Woolgar, *The Positivity of energy for asymptotically anti-de Sitter space-times*, *Class.Quant.Grav.* **11** (1994) 1881–1900, [gr-qc/9404019].
- [179] M. Brigante, H. Liu, R. C. Myers, S. Shenker, and S. Yaida, *Viscosity Bound Violation in Higher Derivative Gravity*, *Phys.Rev.* **D77** (2008) 126006, [arXiv:0712.0805].

- [180] M. Brigante, H. Liu, R. C. Myers, S. Shenker, and S. Yaida, *The Viscosity Bound and Causality Violation*, *Phys.Rev.Lett.* **100** (2008) 191601, [arXiv:0802.3318].
- [181] D. M. Hofman and J. Maldacena, *Conformal collider physics: Energy and charge correlations*, *JHEP* **0805** (2008) 012, [arXiv:0803.1467].
- [182] D. M. Hofman, *Higher Derivative Gravity, Causality and Positivity of Energy in a UV complete QFT*, *Nucl.Phys.* **B823** (2009) 174–194, [arXiv:0907.1625].
- [183] J. de Boer, M. Kulaxizi, and A. Parnachev, *AdS(7)/CFT(6), Gauss-Bonnet Gravity, and Viscosity Bound*, *JHEP* **1003** (2010) 087, [arXiv:0910.5347].
- [184] J. de Boer, M. Kulaxizi, and A. Parnachev, *Holographic Lovelock Gravities and Black Holes*, *JHEP* **1006** (2010) 008, [arXiv:0912.1877].
- [185] X. O. Camanho and J. D. Edelstein, *Causality constraints in AdS/CFT from conformal collider physics and Gauss-Bonnet gravity*, *JHEP* **1004** (2010) 007, [arXiv:0911.3160].
- [186] X. O. Camanho and J. D. Edelstein, *Causality in AdS/CFT and Lovelock theory*, *JHEP* **1006** (2010) 099, [arXiv:0912.1944].
- [187] X. O. Camanho, J. D. Edelstein, and M. F. Paulos, *Lovelock theories, holography and the fate of the viscosity bound*, *JHEP* **1105** (2011) 127, [arXiv:1010.1682].
- [188] G. T. Horowitz and N. Itzhaki, *Black holes, shock waves, and causality in the AdS / CFT correspondence*, *JHEP* **9902** (1999) 010, [hep-th/9901012].
- [189] B. Swingle, *Entanglement Renormalization and Holography*, *Phys.Rev.* **D86** (2012) 065007, [arXiv:0905.1317].
- [190] I. Heemskerk and J. Polchinski, *Holographic and Wilsonian Renormalization Groups*, *JHEP* **1106** (2011) 031, [arXiv:1010.1264].
- [191] T. Faulkner, H. Liu, and M. Rangamani, *Integrating out geometry: Holographic Wilsonian RG and the membrane paradigm*, *JHEP* **1108** (2011) 051, [arXiv:1010.4036].
- [192] S.-S. Lee, *Quantum Renormalization Group and Holography*, arXiv:1305.3908.

- [193] W. Pauli and F. Villars, *On the Invariant regularization in relativistic quantum theory*, *Rev.Mod.Phys.* **21** (1949) 434–444.
- [194] V. E. Hubeny, M. Rangamani, and T. Takayanagi, *A Covariant holographic entanglement entropy proposal*, *JHEP* **0707** (2007) 062, [arXiv:0705.0016].
- [195] A. C. Wall, *Maximin Surfaces, and the Strong Subadditivity of the Covariant Holographic Entanglement Entropy*, arXiv:1211.3494.
- [196] M. Headrick, *Entanglement Renyi entropies in holographic theories*, *Phys.Rev.* **D82** (2010) 126010, [arXiv:1006.0047].
- [197] T. Hartman, *Entanglement Entropy at Large Central Charge*, arXiv:1303.6955.
- [198] J. Hammersley, *Extracting the bulk metric from boundary information in asymptotically AdS spacetimes*, *JHEP* **0612** (2006) 047, [hep-th/0609202].
- [199] J. Hammersley, *Numerical metric extraction in AdS/CFT*, *Gen.Rel.Grav.* **40** (2008) 1619–1652, [arXiv:0705.0159].
- [200] S. Bilson, *Extracting spacetimes using the AdS/CFT conjecture*, *JHEP* **0808** (2008) 073, [arXiv:0807.3695].
- [201] M. Nozaki, T. Numasawa, A. Prudenziati, and T. Takayanagi, *Dynamics of Entanglement Entropy from Einstein Equation*, *Phys.Rev.* **D88** (2013) 026012, [arXiv:1304.7100].
- [202] J. Bhattacharya and T. Takayanagi, *Entropic Counterpart of Perturbative Einstein Equation*, *JHEP* **1310** (2013) 219, [arXiv:1308.3792].
- [203] V. E. Hubeny, M. Rangamani, and E. Tonni, *Thermalization of Causal Holographic Information*, *JHEP* **1305** (2013) 136, [arXiv:1302.0853].
- [204] V. E. Hubeny, M. Rangamani, and E. Tonni, *Global properties of causal wedges in asymptotically AdS spacetimes*, arXiv:1306.4324.
- [205] R. Bousso, S. Leichenauer, and V. Rosenhaus, *Light-sheets and AdS/CFT*, *Phys.Rev.* **D86** (2012) 046009, [arXiv:1203.6619].
- [206] B. Czech, J. L. Karczmarek, F. Nogueira, and M. Van Raamsdonk, *The Gravity Dual of a Density Matrix*, *Class.Quant.Grav.* **29** (2012) 155009, [arXiv:1204.1330].



- [207] S. Hawking, *Gravitational radiation from colliding black holes*, *Phys.Rev.Lett.* **26** (1971) 1344–1346.
- [208] T. Jacobson and R. Parentani, *Horizon entropy*, *Found.Phys.* **33** (2003) 323–348, [gr-qc/0302099].
- [209] R. P. Geroch, *The domain of dependence*, *J.Math.Phys.* **11** (1970) 437–439.
- [210] D. N. Kabat, *Black hole entropy and entropy of entanglement*, *Nucl.Phys.* **B453** (1995) 281–302, [hep-th/9503016].
- [211] F. Larsen and F. Wilczek, *Renormalization of black hole entropy and of the gravitational coupling constant*, *Nucl.Phys.* **B458** (1996) 249–266, [hep-th/9506066].
- [212] D. Iellici and V. Moretti, *Kabat’s surface terms in the zeta function approach*, hep-th/9703088.
- [213] A. R. Zhitnitsky, *Entropy, Contact Interaction with Horizon and Dark Energy*, *Phys.Rev.* **D84** (2011) 124008, [arXiv:1105.6088].
- [214] W. Donnelly and A. C. Wall, *Do gauge fields really contribute negatively to black hole entropy?*, *Phys.Rev.* **D86** (2012) 064042, [arXiv:1206.5831].
- [215] S. N. Solodukhin, *Remarks on effective action and entanglement entropy of Maxwell field in generic gauge*, *JHEP* **1212** (2012) 036, [arXiv:1209.2677].
- [216] C. Eling, Y. Oz, and S. Theisen, *Entanglement and Thermal Entropy of Gauge Fields*, arXiv:1308.4964.
- [217] W. Donnelly and A. C. Wall, *Entanglement entropy of electromagnetic edge modes*, arXiv:1412.1895.
- [218] L. Susskind and E. Witten, *The Holographic bound in anti-de Sitter space*, hep-th/9805114.
- [219] B. Freivogel and B. Mosk, *Properties of Causal Holographic Information*, *JHEP* **1309** (2013) 100, [arXiv:1304.7229].
- [220] M. Gell-Mann and J. Hartle, *Quasiclassical Coarse Graining and Thermodynamic Entropy*, *Phys.Rev.* **A76** (2007) 022104, [quant-ph/0609190].
- [221] A. C. Wall, *Ten Proofs of the Generalized Second Law*, *JHEP* **0906** (2009) 021, [arXiv:0901.3865].

- [222] R. D. Sorkin, *Introduction to Topological Geons*, in *NATO ASIB Proc. 138: Topological Structure of Space-Time* (P. G. Bergmann and V. de Sabbata, eds.), p. 249, 1986.
- [223] J. Louko and D. Marolf, *Single exterior black holes and the AdS / CFT conjecture*, *Phys.Rev.* **D59** (1999) 066002, [hep-th/9808081].
- [224] A. R. H. Smith and R. B. Mann, *Looking Inside a Black Hole*, arXiv:1309.4125.
- [225] P. Bizon and A. Rostworowski, *On weakly turbulent instability of anti-de Sitter space*, *Phys.Rev.Lett.* **107** (2011) 031102, [arXiv:1104.3702].
- [226] J. Jalmuzna, A. Rostworowski, and P. Bizon, *A Comment on AdS collapse of a scalar field in higher dimensions*, *Phys.Rev.* **D84** (2011) 085021, [arXiv:1108.4539].
- [227] O. J. Dias, G. T. Horowitz, and J. E. Santos, *Gravitational Turbulent Instability of Anti-de Sitter Space*, *Class.Quant.Grav.* **29** (2012) 194002, [arXiv:1109.1825].
- [228] V. Balasubramanian, B. D. Chowdhury, B. Czech, J. de Boer, and M. P. Heller, *A hole-ographic spacetime*, *Phys.Rev.* **D89** (2014) 086004, [arXiv:1310.4204].
- [229] J. M. Maldacena, *Wilson loops in large N field theories*, *Phys.Rev.Lett.* **80** (1998) 4859–4862, [hep-th/9803002].
- [230] S.-J. Rey and J.-T. Yee, *Macroscopic strings as heavy quarks in large N gauge theory and anti-de Sitter supergravity*, *Eur.Phys.J.* **C22** (2001) 379–394, [hep-th/9803001].
- [231] V. E. Hubeny, *Extremal surfaces as bulk probes in AdS/CFT*, *JHEP* **1207** (2012) 093, [arXiv:1203.1044].
- [232] J. Louko, D. Marolf, and S. F. Ross, *On geodesic propagators and black hole holography*, *Phys.Rev.* **D62** (2000) 044041, [hep-th/0002111].
- [233] S. B. Giddings and M. Lippert, *Precursors, black holes, and a locality bound*, *Phys.Rev.* **D65** (2002) 024006, [hep-th/0103231].
- [234] G. Gibbons and N. Warner, *Global Structure of Five-dimensional BPS Fuzzballs*, arXiv:1305.0957.

- [235] S. B. Giddings and S. F. Ross, *D3-brane shells to black branes on the Coulomb branch*, *Phys.Rev.* **D61** (2000) 024036, [hep-th/9907204].
- [236] I. Chepelev and R. Roiban, *A Note on correlation functions in AdS(5) / SYM(4) correspondence on the Coulomb branch*, *Phys.Lett.* **B462** (1999) 74–80, [hep-th/9906224].
- [237] R. Bousso, B. Freivogel, S. Leichenauer, V. Rosenhaus, and C. Zukowski, *Null Geodesics, Local CFT Operators and AdS/CFT for Subregions*, arXiv:1209.4641.
- [238] S. Leichenauer and V. Rosenhaus, *AdS black holes, the bulk-boundary dictionary, and smearing functions*, *Phys.Rev.* **D88** (2013) 026003, [arXiv:1304.6821].
- [239] B. Czech, J. L. Karczmarek, F. Nogueira, and M. Van Raamsdonk, *Rindler Quantum Gravity*, *Class.Quant.Grav.* **29** (2012) 235025, [arXiv:1206.1323].
- [240] V. E. Hubeny, H. Maxfield, M. Rangamani, and E. Tonni, *Holographic entanglement plateaux*, arXiv:1306.4004.
- [241] V. E. Hubeny, D. Marolf, and M. Rangamani, *Hawking radiation in large N strongly-coupled field theories*, *Class.Quant.Grav.* **27** (2010) 095015, [arXiv:0908.2270].
- [242] V. E. Hubeny, D. Marolf, and M. Rangamani, *Black funnels and droplets from the AdS C-metrics*, *Class.Quant.Grav.* **27** (2010) 025001, [arXiv:0909.0005].
- [243] V. E. Hubeny, D. Marolf, and M. Rangamani, *Hawking radiation from AdS black holes*, *Class.Quant.Grav.* **27** (2010) 095018, [arXiv:0911.4144].
- [244] J. E. Santos and B. Way, *Black Funnels*, *JHEP* **1212** (2012) 060, [arXiv:1208.6291].
- [245] A. C. Wall, *The Generalized Second Law implies a Quantum Singularity Theorem*, *Class.Quant.Grav.* **30** (2013) 165003, [arXiv:1010.5513].
- [246] O. J. Dias, G. T. Horowitz, D. Marolf, and J. E. Santos, *On the Nonlinear Stability of Asymptotically Anti-de Sitter Solutions*, *Class.Quant.Grav.* **29** (2012) 235019, [arXiv:1208.5772].
- [247] V. Balasubramanian, B. Czech, B. D. Chowdhury, and J. de Boer, *The entropy of a hole in spacetime*, *JHEP* **1310** (2013) 220, [arXiv:1305.0856].

- [248] T. Faulkner, A. Lewkowycz, and J. Maldacena, *Quantum corrections to holographic entanglement entropy*, *JHEP* **1311** (2013) 074, [arXiv:1307.2892].
- [249] R. M. Wald, *Black hole entropy is the Noether charge*, *Phys.Rev.* **D48** (1993) 3427–3431, [gr-qc/9307038].
- [250] V. Iyer and R. M. Wald, *Some properties of Noether charge and a proposal for dynamical black hole entropy*, *Phys.Rev.* **D50** (1994) 846–864, [gr-qc/9403028].
- [251] D. D. Blanco, H. Casini, L.-Y. Hung, and R. C. Myers, *Relative Entropy and Holography*, *JHEP* **1308** (2013) 060, [arXiv:1305.3182].
- [252] D. Kabat, G. Lifschytz, S. Roy, and D. Sarkar, *Holographic representation of bulk fields with spin in AdS/CFT*, *Phys.Rev.* **D86** (2012) 026004, [arXiv:1204.0126].
- [253] T. Hartman and J. Maldacena, *Time Evolution of Entanglement Entropy from Black Hole Interiors*, *JHEP* **1305** (2013) 014, [arXiv:1303.1080].
- [254] P. Calabrese and J. L. Cardy, *Evolution of entanglement entropy in one-dimensional systems*, *J.Stat.Mech.* **0504** (2005) P04010, [cond-mat/0503393].
- [255] S. D. Mathur, *The Fuzzball proposal for black holes: An Elementary review*, *Fortsch.Phys.* **53** (2005) 793–827, [hep-th/0502050].
- [256] S. L. Braunstein, S. Pirandola, and K. Życzkowski, *Better Late than Never: Information Retrieval from Black Holes*, *Phys.Rev.Lett.* **110** (2013), no. 10 101301, [arXiv:0907.1190].
- [257] A. Almheiri, D. Marolf, J. Polchinski, and J. Sully, *Black Holes: Complementarity or Firewalls?*, *JHEP* **1302** (2013) 062, [arXiv:1207.3123].
- [258] V. Balasubramanian, P. Hayden, A. Maloney, D. Marolf, and S. F. Ross, *Multiboundary Wormholes and Holographic Entanglement*, *Class.Quant.Grav.* **31** (2014) 185015, [arXiv:1406.2663].
- [259] T. Jacobson, *Thermodynamics of space-time: The Einstein equation of state*, *Phys.Rev.Lett.* **75** (1995) 1260–1263, [gr-qc/9504004].
- [260] R. C. Myers, J. Rao, and S. Sugishita, *Holographic Holes in Higher Dimensions*, *JHEP* **1406** (2014) 044, [arXiv:1403.3416].

- [261] B. Czech, X. Dong, and J. Sully, *Holographic Reconstruction of General Bulk Surfaces*, arXiv:1406.4889.
- [262] V. Balasubramanian, B. D. Chowdhury, B. Czech, and J. de Boer, *Entwinement and the emergence of spacetime*, arXiv:1406.5859.
- [263] I. A. Morrison, *Boundary-to-bulk maps for AdS causal wedges and the Reeh-Schlieder property in holography*, arXiv:1403.3426.
- [264] S. Gao and R. M. Wald, *The 'Physical process' version of the first law and the generalized second law for charged and rotating black holes*, *Phys.Rev. D* **64** (2001) 084020, [gr-qc/0106071].
- [265] J. M. Maldacena, *Eternal black holes in anti-de Sitter*, *JHEP* **0304** (2003) 021, [hep-th/0106112].
- [266] K. Skenderis and B. C. van Rees, *Holography and wormholes in 2+1 dimensions*, *Commun.Math.Phys.* **301** (2011) 583–626, [arXiv:0912.2090].
- [267] J. Louko, *Single exterior black holes*, *Lect.Notes Phys.* **541** (2000) 188–202, [gr-qc/9906031].
- [268] S. D. Mathur, *Fuzzballs and the information paradox: A Summary and conjectures*, arXiv:0810.4525.
- [269] V. Balasubramanian, J. de Boer, S. El-Showk, and I. Messamah, *Black Holes as Effective Geometries*, *Class.Quant.Grav.* **25** (2008) 214004, [arXiv:0811.0263].
- [270] B. D. Chowdhury and A. Virmani, *Modave Lectures on Fuzzballs and Emission from the D1-D5 System*, arXiv:1001.1444.