

**UCLA**

**UCLA Electronic Theses and Dissertations**

**Title**

Ultra-high Throughput Real-time Instruments for Capturing Fast Signals and Rare Events

**Permalink**

<https://escholarship.org/uc/item/3ck8f4b9>

**Author**

Buckley, Brandon Walter

**Publication Date**

2013

Peer reviewed|Thesis/dissertation

UNIVERSITY OF CALIFORNIA  
Los Angeles

**Ultra-high Throughput Real-time Instruments for  
Capturing Fast Signals and Rare Events**

A dissertation submitted in partial satisfaction  
of the requirements for the degree  
Doctor of Philosophy in Physics

by

**Brandon Walter Buckley**

2013

© Copyright by  
Brandon Walter Buckley  
2013

ABSTRACT OF THE DISSERTATION

# Ultra-high Throughput Real-time Instruments for Capturing Fast Signals and Rare Events

by

**Brandon Walter Buckley**

Doctor of Philosophy in Physics

University of California, Los Angeles, 2013

Professor Bahram Jalali, Co-chair

Professor Eric Hudson, Co-chair

Wide-band signals play important roles in the most exciting areas of science, engineering, and medicine. To keep up with the demands of exploding internet traffic, modern data centers and communication networks are employing increasingly faster data rates. Wide-band techniques such as pulsed radar jamming and spread spectrum frequency hopping are used on the battlefield to wrestle control of the electromagnetic spectrum. Neurons communicate with each other using transient action potentials that last for only milliseconds at a time. And in the search for rare cells, biologists flow large populations of cells single file down microfluidic channels, interrogating them one-by-one, tens of thousands of times per second. Studying and enabling such high-speed phenomena pose enormous technical challenges. For one, parasitic capacitance inherent in analog electrical components limits their response time. Additionally, converting these fast analog signals to the digital domain requires enormous sampling speeds, which can lead to significant jitter and distortion. State-of-the-art imaging technologies, essential for studying biological dynamics and cells in flow, are limited in speed and sensitivity by finite charge transfer and read rates, and by the small numbers of photo-electrons accumulated in short integration times. And finally, ultra-high throughput real-time digital processing is required at the backend to analyze the streaming data. In this thesis, I discuss my work in developing real-time instruments, employing ultrafast optical techniques, which overcome some of these obstacles. In particular,

I use broadband dispersive optics to slow down fast signals to speeds accessible to high-bit depth digitizers and signal processors. I also apply telecommunication multiplexing techniques to boost the speeds of confocal fluorescence microscopy.

The photonic time stretcher (TiSER) uses dispersive Fourier transformation to slow down analog signals before digitization and processing. The act of time-stretching effectively boosts the performance of the back-end electronics and digital signal processors. The slowed down signals reach the back-end electronics with reduced bandwidth, and are therefore less affected by high-frequency roll-off and distortion. Time-stretching also increases the effective sampling rate of analog-to-digital converters and reduces aperture jitter, thereby improving resolution. Finally, the instantaneous throughputs of digital signal processors are enhanced by the stretch factor to otherwise unattainable speeds. Leveraging these unique capabilities, TiSER becomes the ideal tool for capturing high-speed signals and characterizing rare phenomena. For this thesis, I have developed techniques to improve the spectral efficiency, bandwidth, and resolution of TiSER using polarization multiplexing, all-optical modulation, and coherent dispersive Fourier transformation. To reduce the latency and improve the data handling capacity, I have also designed and implemented a real-time digital signal processing electronic backend, achieving 1.5 tera-bit per second instantaneous processing throughput. Finally, I will present results from experiments highlighting TiSER's impact in real-world applications.

Confocal fluorescence microscopy is the most widely used method for unveiling the molecular composition of biological specimens. However, the weak optical emission of fluorescent probes and the tradeoff between imaging speed and sensitivity is problematic for acquiring blur-free images of fast phenomena and cells flowing at high speed. Here I introduce a new fluorescence imaging modality, which leverages techniques from wireless communication to reach record pixel and frame rates. Termed Fluorescence Imaging using Radio-frequency tagged Emission (FIRE), this new imaging modality is capable of resolving never before seen dynamics in living cells - such as action potentials in neurons and metabolic waves in astrocytes - as well as performing high-content image assays of cells and particles in high-speed flow.

The dissertation of Brandon Walter Buckley is approved.

David Saltzberg

Mayank Mehta

Asad M. Madni

Eric Hudson, Committee Co-chair

Bahram Jalali, Committee Co-chair

University of California, Los Angeles

2013

*To my parents*

# TABLE OF CONTENTS

<b>1</b>	<b>Introduction</b>	<b>1</b>
1.1	High-speed Signals and Rare Events	1
1.2	Analog to Digital Converters	5
1.2.1	Photonic time-stretch	7
1.3	High-speed Fluorescence Imaging	12
<b>2</b>	<b>Photonic Time-Stretch: Fundamentals</b>	<b>16</b>
2.1	Optical Pulse Propagation	16
2.1.1	Origin of Dispersion	21
2.2	Stationary Phase Approximation	22
2.3	Photonic Time-Stretch	23
2.4	Electro-optic Modulation	25
2.5	Non-linear Distortion in Time-stretch	28
2.6	Dispersion Penalty and Time-Bandwidth Product	30
<b>3</b>	<b>Doubling the Spectral Efficiency of Time-Stretch with Polarization Multiplexing</b>	<b>32</b>
3.1	Introduction	32
3.2	Prototype System	34
3.3	Performance Results	37
3.4	Conclusion	38
<b>4</b>	<b>All-Optical Time-stretch Transformation</b>	<b>40</b>
4.1	Introduction	40



4.2	Principle of Operation . . . . .	41
4.3	Prototype System . . . . .	44
4.4	Dispersion Penalty and its Mitigation Using Single-Sideband Filtering . . . . .	48
4.5	Conclusion . . . . .	50
<b>5</b>	<b>Coherent Time-Stretch Transformation . . . . .</b>	<b>51</b>
5.1	Introduction . . . . .	51
5.2	Coherent Detection . . . . .	53
5.3	Coherent Dispersive Fourier Transform . . . . .	54
5.4	Experimental Setup . . . . .	59
5.5	Digital Signal Processing . . . . .	60
5.6	Dispersion Compensation . . . . .	61
5.7	Conclusion . . . . .	67
<b>6</b>	<b>Photonic Time-Stretch Applications . . . . .</b>	<b>68</b>
6.1	Performance Monitoring 100 Gbps DQPSK Signal . . . . .	68
6.2	Real-time Bit-error Rate Estimation . . . . .	76
6.2.1	Probabilistic BER Estimation . . . . .	77
6.2.2	Integration in Optical Packet Switching Test-bed . . . . .	79
6.3	Instantaneous High-Resolution Wide-band Spectral Sweep . . . . .	81
<b>7</b>	<b>Time-stretch Accelerated Real-time Digital Signal Processing . . . . .</b>	<b>86</b>
7.1	Introduction . . . . .	87
7.2	System Overview . . . . .	89
7.2.1	Photonic Time-stretch Front-end . . . . .	89
7.2.2	Digitizer/Processing Board . . . . .	90

7.3	FPGA Logic Design . . . . .	93
7.3.1	Synchronization . . . . .	94
7.3.2	Framing . . . . .	96
7.3.3	Averaging . . . . .	98
7.3.4	Division . . . . .	99
7.4	Results . . . . .	100
7.4.1	Device Utilization Summary . . . . .	101
7.5	Future Work . . . . .	101
7.6	Conclusion . . . . .	102
<b>8</b>	<b>Sub-millisecond Fluorescence Microscopy using Beat-frequency Multi-plexed Excitation . . . . .</b>	<b>103</b>
8.1	Introduction . . . . .	103
8.2	Photodetection and digitization of fluorescence signals . . . . .	114
8.3	Digital Signal Processing . . . . .	114
8.4	Two-dimensional image scanning . . . . .	116
8.5	Imaging Flow Cytometry . . . . .	118
8.6	FIRE design criteria - spatial resolution, number of pixels, and field of view . . . . .	118
8.7	Shot noise-limited SNR analysis . . . . .	119
8.8	Optical sectioning capability . . . . .	123
8.9	Cell culture, Cell staining, and Microfluidic channel fabrication . . . . .	124
<b>9</b>	<b>Conclusion . . . . .</b>	<b>126</b>
	<b>References . . . . .</b>	<b>127</b>

## LIST OF FIGURES

1.1	Many types of cells circulate through the body in the blood stream. Most of those are red blood cells and platelets. However, many types of extremely rare cells are of great importance. In this table we list a subset of the cell types found in the blood stream. The ones highlighted are rare cells with enormous impacts on medicine and biology. . . . .	4
1.2	State-of-the-art ADCs, arranged based on their analog operating bandwidth and ENOB (Courtesy of reference [1]). Fundamental limits are plotted due to thermal noise, aperture jitter, and comparator ambiguity. The quantum limit is also plotted. I have added the results from the photonic time-stretch ADC as labeled. . . . .	7
1.3	Photonic time-stretch slows down wideband analog signals, reducing their bandwidth, so that they can be captured by lower speed, higher resolution analog-to-digital converters. . . . .	9
1.4	Schematic of TISER. An analog RF input is modulated onto a pre-chirped broadband optical pulse train and stretched in a dispersive fiber resulting in a reduced bandwidth copy of the original signal. The optical signal is converted back to the electrical domain at the photodetector (PD). The signal is then digitized and processed by a real-time ADC and digital processor. . . . .	10
1.5	The state-of-the-art in high-speed, sensitive optical imaging are the EMCCD and sCMOS cameras. As illustrated here, EMCCDs provide superior SNR at the lowest photon levels, while sCMOS is the better technology for brighter samples. Courtesy of reference [2]. . . . .	14
2.1	Schematic of a dual-drive Mach-Zehnder modulator. . . . .	26
2.2	Sinusoidal modulation transfer function typical of a MZM. The gray region centered at the quadrature point indicates the approximately linear operating region. . . . .	28

3.1	By staggering two orthogonally polarized pre-dispersed time-stretch pulses, we can double the time-aperture of TiSER for the same optical bandwidth. The result is a doubling of the time-bandwidth product. . . . .	34
3.2	Schematic of the dual-polarization photonic time-stretcher (DP-TiSER). MLL: Mode-locked laser, HNLF: Highly non-linear fiber, PC: Polarization controller, Pol: Polarizer, EDFA: Er-doped fiber amplifier, FM: Faraday mirror, PD: Photodetector. In order to mitigate the crosstalk between the polarization channels while stretching in the DCF, we used a double-pass configuration, using an optical circulator and a Faraday mirror. . . . .	36
3.3	(a) Single-tone test with 6 GHz RF signals; (b) two-tone test with 8.2 GHz and 10.25 GHz RF signals. More than 600 segments (300 segments per polarization channel) are stitched coherently to generate these plots. . . . .	37
3.4	Eye-diagram of 12.5Gb/s $2^{31} - 1$ PRBS data captured by the DP-TiSER combined with the TiSER oscilloscope. The number of sample points is twice more than the conventional TiSER oscilloscope. . . . .	38
4.1	Conceptual diagram for our all-optical time-stretch technique, replacing an electro-optic modulator with a four-wave mixing process in the photonic time-stretch. . . . .	41
4.2	(a) Spectral-domain representation. The ultrafast optical data signal ( $f_s$ ) mixes with the broadband pulsed pump ( $\Delta f_p = f_{p1} - f_{p2}$ ) via four-wave mixing (FWM). (b) Time-domain representation. At each time instant along the signal, a wavelength of the pre-chirped broadband pump mixes with the signal at that time instant, creating a chirped modulated idler. The idler is then time-stretched to reduce the analog bandwidth of the optical data signal.	43

4.3	Detailed schematic of the experimental setup for demonstrating the all-optical photonic time-stretcher using four-wave mixing. BW: Bandwidth; EDFA: Erbium-doped fiber amplifier; VOA: Variable optical attenuator; PC: Polarization controller; WDM: Wavelength division multiplexer; HNLF: Highly nonlinear fiber; OSA: Optical spectrum analyzer; PD: Photo-detector; ADC: Analog-to-digital converter. Inset: spectrum of pump, signal, and idler at the output of the HNLF. . . . .	46
4.4	Detailed schematic of the 40-Gb/s non-return-to-zero (NRZ) on-off-keying (OOK) signal transmitter. This unit was implemented to evaluate the performance of the all-optical time-stretch pre-processor. CW: Continuous wave; PC: Polarization controller; EDFA: Erbium-doped fiber amplifier; VOA: Variable optical attenuator; PRBS: Pseudo-random bit stream source. . . .	47
4.5	40-Gb/s non-return-to-zero (NRZ) on-off-keying (OOK) data. (a) Two real-time segments of 40-Gb/s data captured at an effective sampling rate of 1.25 TS/s. (b) Eye-diagram of 40-Gb/s constructed from real-time segments in equivalent-time mode. . . . .	47
4.6	(a) If the optical data signal is double-sideband modulated, the sidebands beat with carrier and result in interference at the photo-detector. (b) Dispersion penalty in an all-optical time-stretch digitizer with an initial dispersion of -150 ps/nm. Note that we intentionally increased the initial dispersion to shift the bandwidth roll-off into the measurable range of our equipment. When double-sideband (DSB) modulation is used, the measured penalty (blue curve) that is in good agreement with theoretical prediction (green solid curve). By employing single-sideband technique, the dispersion penalty is completely mitigated (red curve). (c) Single-sideband modulation is implemented by suppressing one of the sidebands of the optical data signal. An optical bandpass filter can be used for this purpose. . . . .	48

5.1	Mixing of relatively delayed chirped optical pulses results in a beat frequency in the time-domain. In (a) we illustrate the linear chirp of each pulse by a straight line on a frequency vs. time plot. The signal and LO pulses are delayed with respect to each other, resulting in interference of spectral components offset by a constant intermediate frequency, $\omega_{IF}$ . (b) The interference results in a sinusoidal modulation along the optical pulse. If the signal pulse is modulated with an RF signal, the amplitude and phase information is encoded in the IF modulation, analogous to a coherent heterodyne signal.	57
5.2	Interference of two broadband, chirped optical pulses results in an intermediate beat frequency along the pulse. (a) In this example, a time delay of 36 ps between the two pulses results in an intermediate frequency of 4 GHz. (b) We characterized the intermediate frequency for a range of relative delays. The measured dispersion of 1090 ps/nm, calculated from the slope, is in agreement with the dispersive fibers used.	58
5.3	Schematic of the optical portion of the cTSADC system. After photo-detection the time-stretched analog signal is digitized and processed digitally. In this demonstration, balanced detection was performed using a single PD, with the complementary pulses delayed in time to avoid overlap. Subtraction was performed digitally. D1: first dispersive fiber, D2: second dispersive fiber, OBPF: optical band-pass filter, VDL: variable delay line	60
5.4	We capture both outputs of the $2 \times 2$ interferometer and perform subtraction digitally. (a) The complementary outputs (blue and red) are aligned. (b) After subtraction the common mode signal is rejected, and the complementary portions are added, resulting in higher SNR	61

5.5	With direct detection, parasitic dispersion results in transfer function nulls, limiting the bandwidth. In coherent detection we can recover the full complex field, allowing for equalization of the dispersion penalty and a flat transfer function. The roll off at higher frequencies is due to limitations of the intensity modulator. Plotted along with the raw data is a sinusoidal model function fit to the un-equalized direct detection transfer function. The dispersion-induced phase was calculated from Eq. 5.11 and the additional chirp parameter was estimated from non-linear regression. . . . .	63
5.6	Conceptually, the dispersion induced phase acts to rotate the electric field in the complex plane. Each frequency component experiences a different rotation, dependent on the square of the frequency. The total power of the RF signal remains constant, but the balance of power between real-part (blue) and imaginary-part (red) shifts depending on the frequency. Equalization inverts the frequency dependent phase shift, returning all power back to the real-axis (green). Without coherent detection, the full complex field information is lost, and to linear approximation the recovered RF signal matches the attenuated power of the real-part. . . . .	64
5.7	40 Gbps PRBS data was time-stretched and detected using optical direct detection (a) and broadband coherent detection (b). A dispersion penalty transfer function, characterized in Fig. 5.5, imparts a frequency limitation when using direct detection, which can be equalized digitally using coherent detection. Rise/fall times, measured at 10% and 90% levels, improved from 18.5/19.1 ps to 16.1/15.8 ps upon equalization. . . . .	66
6.1	Conceptual diagram of two-RF-channel time-stretch enhanced recording (TiSER) oscilloscope with differential detection front-end for 100-Gb/s RZ-DQPSK signal monitoring. This scheme provides minimal mismatch between the captured I/Q-data. . . . .	70

6.2	Detailed schematic of the 100-Gb/s RZ-DQPSK signal transmitter and optical impairment emulation units. CW: Continuous wave, DGD: Differential group delay, CD: Chromatic dispersion, DL: Delay line, PC: Polarization controller, EDFA: Erbium-doped fiber amplifier, CLK: Clock, BPF: Bandpass filter. . . . .	71
6.3	Detailed schematic of the two-RF-channel time-stretch enhanced recording (TiSER) oscilloscope with differential detection front-end. Solid (black) and dashed (red) lines represent optical fibers and electrical cables, respectively. DLI: Delay line interferometer, BRx: Balanced receiver, MZM: Mach-Zehnder modulator, EDFA: Erbium-doped fiber amplifier, MLL: Mode-locked laser, DL: Delay line, BPF: Bandpass filter, PD: Photodetector, ADC: Analog-to-digital converter, PC: Polarization controller, DCF: Dispersion compensating fiber. . . . .	73
6.4	Eye and constellation diagrams for 100-Gb/s RZ-DQPSK data captured by the two-RF-channel TiSER oscilloscope. I/Q diagrams (a)-(c) without any channel impairments, (d)-(f) with 10-dB optical loss, (g)-(i) with differential group delay of 5 ps, (j)-(k) with chromatic dispersion of -20 ps/nm. . . . .	75
6.5	Eye-diagram of a 40 Gb/s RZ-OOK $2^{15} - 1$ PRBS signal time-stretched by 24. . . . .	79
6.6	TiSER was inserted into the packet-switching network test-bed at Columbia University as an optical performance monitor. TiSER successfully generated eye-diagrams and measured BER from $32\mu\text{s}$ packets of data. . . . .	81
6.7	Using quadratic interpolation and a windowing function, we can improve the spectral resolution of our frequency measurement. . . . .	84
6.8	TiSER simulation. Over a 40 GHz frequency range, the frequency error was calculated using the peak from the rectangular window and with quadratic interpolation using a Hann window. Simulations indicate $\pm 125$ MHz resolution with a sweep time of 37 MHz. . . . .	85



7.1	High level block diagram of real-time TiSER prototype and test setup. The signal generator consisted of a pseudo-random bit sequence (PRBS) generator. The board was directly clocked by the signal clock, running at 20 GHz, divided by 16. The time-stretch mode-locked laser (MLL) trigger required pulse shaping to meet the requirements as an input to the FPGA. . . . .	89
7.2	Schematic of the photonic time-stretch frontend. MLL: Mode Lock Laser, D1: first dispersive fiber, PC: polarization controller, MZM: Mach-Zehnder modulator, D2: second dispersive fiber, OBPF: optical band-pass filter, PD: photo-detector, RF LNA: RF low noise amplifier . . . . .	90
7.3	Block Diagram of the Custom Designed 3 GS/s Digitizer Board . . . . .	91
7.4	Analog RF electronics reshaped the synchronized impulse response train from the MLL to meet the requirements for an input to the FPGA. (A) Raw impulse response output from the PD in the MLL. The pulse width ( $< 1ns$ ) is too short to trigger the FPGA. (B) A 117 MHz filter broadened the pulses, while significantly attenuating the overall power. (C) An inverting amplifier inverted the pulses, effectively broadening the top portion of the pulse. (D) Finally a 500 MHz, 25 dB gain low noise amplifier (LNA) and bias of 1.1V brought the pulses to the necessary range to trigger the FPGA. . . . .	92
7.5	Flow chart of DSP in FPGA . . . . .	93
7.6	State machine diagram for the synchronization module. . . . .	95
7.7	State machine diagram for the framing module. . . . .	97
7.8	330 overlaid frames of unmodulated time-stretched pulses. Illustrates the successful synchronization of the FPGA to the MLL . . . . .	98
7.9	RMS deviation from the true envelope was calculated after averaging over varying numbers of pulses. The general trend is a more accurate recover of envelope for large number of averages, with diminishing returns beginning around 1000. . . . .	99

8.1	Schematic diagram of the FIRE microscope. BS: beamsplitter AOD: acousto-optic deflector AOFS: acousto-optic frequency shifter DM: dichroic mirror EF: fluorescence emission filter OL: objective lens PMT: photomultiplier tube DIG: 250 MS/s digital recording oscilloscope RS: resonant scanning mirror. Upper inset: the AOD produces a single diffracted 1st order beam for each RF comb frequency. Lower inset: beat frequency generation at the Mach-Zehnder interferometer (MZI) output. Not shown: A cylindrical lens is placed after the AOFS to match the divergence of the local oscillator (LO) beam to that of the RF beams. . . . .	106
8.2	Gabor lattice diagram of FIREs frequency-domain multiplexing approach. Points in the horizontal direction are excited in parallel at distinct radiofrequencies. Scanning this line scan excitation in the vertical direction using a galvanometer generates a two-dimensional image. . . . .	108
8.3	Illustration of the radiofrequency tagging of fluorescent emission in FIRE. (A) Time domain data output from the PMT. (B) Short-time Fourier transforms of the signal in (A), indicating the bead horizontal positions. (C) $256 \times 256$ pixel image of three immobilized fluorescent beads recorded using 256 excitation frequencies. The sample was imaged at a 4.4-kHz frame rate. The vertical axis in the image is oversampled to yield 256 pixels. Scale bar = $30 \mu m$ . . . . .	109

8.4	Comparison of FIRE microscopy with widefield fluorescence imaging. 488nm laser excitation was used for FIRE imaging ( $8.5\mu W$ per pixel, measured before the objective), and mercury lamp excitation was used for widefield imaging. All FIRE images use an RF comb frequency spacing of 400 kHz, and are composed of $200\times 92$ pixels. Slight vignetting is observed in the FIRE images due to the mismatch of the Gaussian profile of the LO beam with the flat-top RF comb beam. This mismatch and the resulting vignetting can be eliminated using digital pre-equalization of the RF comb in the direct digital synthesis (DDS) generator. The particular objective lens used is denoted in each FIRE image. (A-C) C6 astrocytes stained with Syto16. Scale bars = $10\ \mu m$ . (D) <i>S. cerevisiae</i> yeast stained with Calcein AM. Scale bars = $5\ \mu m$ . (E,F) NIH 3T3 cells stained with Calcein AM. Scale bars = $20\ \mu m$ . . . . .	110
8.5	High-speed imaging flow cytometry. All images are of MCF-7 breast carcinoma cells, stained with Syto16, taken using a 60x, 0.70-NA objective lens. (A) Representative FIRE images of cells flowing at a velocity of 1 m/s, taken using a pixel frequency spacing of 800 kHz, and $54\ \mu W$ of 488-nm laser power per pixel, measured before the objective. (B) Single $10\text{-}\mu s$ exposure frame transfer EMCCD images of individual cells flowing at a velocity of 1 m/s. The electron multiplier gain was adjusted to produce maximal image SNR, and the EMCCD vertical shift time was set to 564 ns. Blur is observed in the image due to the long exposure time and the frame transfer nature of the EMCCD. (C) Representative widefield fluorescence images of stationary MCF-7 cells. All scale bars are $10\ \mu m$ . . . . .	112
8.6	Intermediate image processing steps of FIRE images. After obtaining the raw image (A) from the FIRE system, the image is spatially filtered (B). A sine correction algorithm is applied (C), along with a median filter, to correct for artifacts introduced by the sine correction. Finally, the image is rescaled in intensity (D) to adjust the image saturation and remove any background. . . . .	117

8.7	The SNR at a particular pixel is dependent on the number of photons incident at that pixel as well as the total number of photons incident at all the other pixels in a line. In this figure, we plot the required number of photons detected at some pixel $k$ to achieve a shot noise limited SNR of 10, vs. the ratio of the number of photons incident on pixel $k$ to the total number of photons incident on a line (c.f. Equation 8.1). As illustrated, the required number of photons detected at pixel $k$ for an SNR of 10 decreases as the signal at pixel $k$ increasingly dominates the total signal detected. For sparse samples, the sensitivity of FIRE improves. The insets illustrate examples of a linescan with the corresponding $N_k/N_{tot}$ ratio. . . . .	122
8.8	Measured axial resolution of FIRE. A Gaussian fit to the data shows a $5.9 \mu m$ FWHM. The measurement is based on exciting a 500 nm fluorescent bead with 488-nm excitation, and scanning the sample through the focus at $1 \mu m$ intervals, using 488-nm excitation. A $100\times$ , 1.4-NA oil immersion objective was used in combination with a 200-mm focal length tube lens and a $100\text{-}\mu m$ tall slit aperture placed before the PMT. . . . .	124

## LIST OF TABLES

7.1	List of variables used in logic design descriptions . . . . .	94
7.2	Slice Logic Utilization . . . . .	101

## ACKNOWLEDGMENTS

First and foremost I am thankful to my advisor, Prof. Bahram Jalali, for his enormous support and guidance. His energy, drive, and passion have been inspirational, and I have grown leaps and bounds personally and professionally from the time I've spent with him.

Wholeheartedly I thank Prof. Asad Madni. I have been inspired by his passion for engineering and teaching, his knowledge, his leadership, and above all, his spirit. His insightful feedback and guidance were critical in completing this work, and I am especially grateful for his support during the writing of my dissertation.

I thank Prof. Eric Hudson for co-chairing my committee and for his guidance during my PhD studies. I also thank Profs. David Saltzberg and Mayank Mehta for participating on my committee and for their valuable feedback.

I am especially appreciative of the amazing students and postdocs Prof. Jalali has gathered together in his group. Working daily with such smart and motivated people has made my time in graduate school such a memorable and worthwhile experience. I wish to thank Eric Diebold, Daniel Solli, Ali Fard, Jost Adam, Cejo Konuparamban Lonappan, and Ali Ayazi. As teachers, collaborators, and role models, they have helped shape me into the scientist and person I am today.

I am grateful to the National Science Foundation's Center for Integrated Access Networks for financial support and for the educational experience they fostered. I thank our collaborators, Profs. Keren Bergman (Columbia University), Alan Willner (USC), and Stojan Radic (UCSD), and their students and postdocs, Caroline Lai, Daniel Brunina, Jeng-Yuan Yang, Mohammad R. Chitgarha, Sanja Zlatanovic, Camille-Sophie Brès, and Andreas Wiberg.

I have had many mentors over the course of my education, and I wish to thank a few in particular who have led me to this PhD in Physics: Mr. Jim Frank, Mr. James Hardy, Dr. Eric Drier, and Prof. Georg Hoffstaetter. I give special thanks as well to Dr. Bruce

Stillman for his guidance throughout all of my academic pursuits.

Most important of all, I am supremely grateful to my entire family for their unwavering love and support. Especially to my parents and my two little sisters... you have been the constant thread throughout my entire life. Thank you for always being there.

## VITA

- 2007            B.A. Physics  
                  Cornell University  
                  Ithaca, New York, USA
- 2007-2009      Teaching Assistant  
                  Department of Physics and Astronomy  
                  University of California, Los Angeles  
                  Los Angeles, California, USA
- 2009, 2010      Physics and Astronomy Outstanding Teaching Award  
                  University of California, Los Angeles  
                  Los Angeles, California, USA
- 2009            M.S. Physics  
                  University of California, Los Angeles  
                  Los Angeles, California, USA
- 2009-2013      Graduate Student Researcher  
                  Department of Electrical Engineering  
                  University of California, Los Angeles  
                  Los Angeles, California, USA

## PUBLICATIONS AND PRESENTATIONS

**Brandon W. Buckley**, Asad M. Madni, Bahram Jalali, "Coherent time-stretch transformation for real-time capture of wide-band signals", Optics Express (to be published)



Eric D. Diebold, **Brandon W. Buckley**, Daniel R. Gosset, Bahram Jalali, "Digitally synthesized beat frequency multiplexing for sub-millisecond fluorescence microscopy", Nature Photonics (to be published)

C. P. Lai, D. Brunina, **B. W. Buckley**, C. Ware, W. J. Zhang, A. S. Garg, B. Jalali, and K. Bergman, "First Demonstration of a Cross-Layer Enabled Network Node", Journal of Lightwave Technology, vol. 31, pp. 1512-1525, May 2013.

Daniel Lam, Ali M. Fard, **Brandon Buckley**, and Bahram Jalali, "Digital broadband linearization of optical links", Optics Letters, Vol. 38, Issue 4, pp. 446-448 (2013)

A. M. Fard, **B. Buckley**, S. Zlatanovic, C. S. Bres, S. Radic, and B. Jalali, "All-optical time-stretch digitizer," Applied Physics Letters, vol. 101, Jul 30 2012.

A. Fard, J. Y. Yang, **B. Buckley**, J. Wang, M. R. Chitgarha, L. Zhang, A. E. Willner, and B. Jalali, "Time-stretch oscilloscope with dual-channel differential detection front end for monitoring of 100 Gb/s return-to-zero differential quadrature phase-shift keying data," Optics Letters, vol. 36, pp. 3804- 3806, Oct 1 2011.

A. Fard, **B. Buckley**, and B. Jalali, "Spectral Efficiency Improvement in Photonic Time-Stretch Analog-to-Digital Converter via Polarization Multiplexing," IEEE Photonics Technology Letters, vol. 23, pp. 947-949, Jul 15 2011.

**B. Buckley** and G. H. Hoffstaetter, "Transverse emittance dilution due to coupler kicks in linear accelerators," Physical Review Special Topics-Accelerators and Beams, vol. 10, Nov 2007.

**Brandon W. Buckley**, Ali Fard, and Bahram Jalali , "Time-Stretch Analog-to-Digital Conversion Using Phase Modulation and Broadband Balanced Coherent Detection for Im-

proving Resolution”, Optical Fiber Communication Conference, Los Angeles, California, United States, March 6-10, 2011, Optical Processing Devices (OThW)

Ali Fard, **Brandon Buckley**, and Bahram Jalali, ”Doubling the Spectral Efficiency of Photonic Time-Stretch Analog-to-Digital Converter by Polarization Multiplexing”, Frontiers in Optics, Rochester, New York, United States, October 24-28, 2010, Optical Signal Processing Device (FThI)

C. Lai, A. M. Fard, **B. Buckley**, B. Jalali, and K. Bergman, ”Cross-Layer Signal Monitoring in an Optical Packet-Switching Test-Bed via Real-Time Burst Sampling,” IEEE Photonics Society 23rd Annual Meeting 2010, paper ME3.

Ali M. Fard., **Brandon Buckley**, and Bahram Jalali, ”Doubling the Spectral Efficiency of Photonic Time-Stretch Analog-to-Digital Converter by Polarization Multiplexing,” Frontiers in Optics (FiO) 2010, paper IO-C-589-FiO.

Ali M. Fard. Jeng-Yuan Yang, **Brandon Buckley**, Jian Wang, Mohammad R. Chitgarha, Lin Zhang, Alan E. Willner, and Bahram Jalali, ”100-Gb/s RZ-DQPSK Signal Monitoring Using Time-Stretch Enhanced Recording Oscilloscope,” CLEO 2011 Conference, paper CFP1.

”Wideband Real-time A/D Conversion and Biological Imaging Enabled by Photonic Time Stretch”, Presented at Optical Fiber Communication Conference, Los Angeles, California, United States, March 6-10, 2011, Workshop(OSuD)

”Optical Performance Monitoring in the CIAN Cross-Layer Network Test-Bed using the Time-Stretch Oscilloscope”, Presented at the NSF Center for Integrated Access Networks (CIAN) Industrial Affiliates Board Meeting, San Jose, 2010

# CHAPTER 1

## Introduction

### 1.1 High-speed Signals and Rare Events

High-speed signals and rare events play crucial roles in some of the most exciting new areas of science, engineering, and medicine.

In modern communication networks, data is streamed at enormously high-speeds. In the core of the optical network, data from many sources are aggregated to rates reaching many terabits-per-second (Tb/s). Laboratory demonstrations have achieved serial data rates exceeding 10 terabits-per-second (Tb/s)[3]. More recently, researchers have demonstrated 1.05 petabits-per-second (Pb/s) transmission over 52 km on a single optical fiber [4]. But high-data rates are no longer confined to just long haul networks. In modern data centers, thousands of servers communicate and work together using optical cables spanning hundreds of meters and transferring data at hundreds of gigabits-per-second (Gb/s)[5]. And on smaller scales, modern standard transfer protocols, such as PCI Express 4.0 (16 Gb/s/lane)[6], Thunderbolt (10 Gb/s/channel)[7], SATA Revision 3.0 (6 Gb/s)[8], and USB 3.0 (5 Gb/s)[9], all boast enormous speeds. Capturing and analyzing these high-speed signals requires large-bandwidth electronics and analog-to-digital converters (ADCs), with extremely high temporal resolution and low jitter. Additionally, to reach such high data rates, many communication standards employ multi-level phase and amplitude modulation formats, such as phase-shift keying (PSK) and quadrature amplitude modulation (QAM) [10, 11, 12, 13]. Receivers therefore need many bits of amplitude resolution, in addition to high-bandwidths, to accurately recover these signals.

In modern warfare, success on the battlefield is largely determined by how well one

can control the radio-frequency (RF) spectrum. Remote guidance, communication, and surveillance are all performed in the RF domain, and the bandwidths used are expanding. Wideband RF jamming techniques such as sweep, barrage, and pulse jamming, use ultra-wide band signals to corrupt huge portions of the EM spectrum. In response, advanced techniques such as spread spectrum frequency hopping exist to counter such jamming efforts, by sending information over ever larger bandwidths [14]. Radar systems are used to scan the full RF spectrum to detect these wide-band signals. This field of signals intelligence (SIGINT) relies on high-performance analog electronics and ADCs to find and decipher these signals across large bandwidths and buried in interference and noise [15]. RF techniques also are used as weapons to physically damage receivers. High-power electromagnetic pulses (EMPs) with tens of GHz of microwave bandwidth can cause large bursts of currents at the receiver, melting electronics and permanently damaging integrated circuits [16]. Studying these wide-band signals is critical for defending against attacks, but doing so requires large-bandwidth, high dynamic range electronics and ADCs.

Many important biochemical phenomena operate at high-speeds. Calcium and metabolic waves [17, 18], action potential firing in neurons [19, 20, 21], and calcium release and signaling in cardiac tissue [22] can all operate on millisecond time-scales. A better understanding of these mechanisms may lead to the next breakthroughs in cancer research, treatment of neurological disorders such as Alzheimer’s disease and autism, and heart disease. Some cellular mechanics can also reach such high-speeds. For instance, bacterial flagella propel cells to speeds of up to  $300 \mu\text{m/s}$  by rotating at hundreds of hertz [23], and elastic instabilities in fungi, such as from snap-buckling or explosive fracture, can operate on time scales of well below 1 ms [24]. Capturing such fast events requires cameras with kHz frame rates and sensitivities down to the single photon-per-pixel level.

The challenge of detecting rare events can be compared to finding a needle in a haystack. Typically defined to be one-in-a-thousand phenomena, rare events of interest can sometimes be even scarcer - perhaps one-in-a-billion. Despite their small concentrations, rare-events in nature often have enormous importance. For instance, circulating tumor cells (CTCs), detached from an initial cancer site, may number fewer than 10 in a milliliter sample of

blood - as compared to a billion or more red blood cells [25]. Yet those few CTCs can lead to the spread of cancer throughout the body. Similarly scarce cells in the body, such as hematopoietic stem cells [26], antigen-specific T-cells [27], and circulating fetal cells in pregnant mothers [28], all number less than 1000 in a typical milliliter blood sample, but play vital rolls in the body and carry critical information (Fig. 1.1). An exciting example of rare-events in engineering are optical rogue waves [29], the optical analog of monster oceanic rogue waves. And in particle physics, extremely rare decay processes may go unnoticed amidst a background of hundreds of millions, but detecting them is key in determining whether or not the standard model comprises a complete description of our Universe [30]. When studying such rare events, overcoming the Poissonian noise inherent in quantifying small sample sizes is critical. Therefore, large amounts of data must be captured and analyzed, calling for high-speed, high-throughput capture, processing, and data mining capabilities. Additionally, detecting such rare particles from a large noise background requires detectors with superior sensitivity and resolution.

<b>Blood Component</b>	<b>Concentration (cells / mL of blood)</b>
Erythrocytes (RBC)	5,400,000,000
Thrombocytes	350,000,000
Neutrophils	6,000,000
T Lymphocytes	1,500,000
CD4+ T cells	1,000,000
B Lymphocytes	600,000
Monocytes	500,000
Eosinophils	250,000
Natural Killer Cells	200,000
Basophils	50,000
Dendritic Cells	20,000
<b>Hematopoietic Stem Cells</b>	<b>2,000</b>
<b>Antigen-Specific T Cells</b>	<b>1,000</b>
<b>Circulating Endothelial Cells</b>	<b>500</b>
<b>Fetal Cells in Maternal Blood</b>	<b>500</b>
Endothelial Progenitor Cells	200
<b>Circulating Tumor Cells</b>	<b>10</b>

Figure 1.1: Many types of cells circulate through the body in the blood stream. Most of those are red blood cells and platelets. However, many types of extremely rare cells are of great importance. In this table we list a subset of the cell types found in the blood stream. The ones highlighted are rare cells with enormous impacts on medicine and biology.

## 1.2 Analog to Digital Converters

Analog-to-digital converters (ADCs) map signals from the continuous real-world to the discrete realm of computers. They enable us to leverage the enormous advances made in complementary metaloxidesemiconductor (CMOS) technology over the past few decades to digitally process, share, and store information. As such, they are essential in the study of high-speed signals and rare-events.

ADCs quantize analog signals at periodic intervals, thereby discretizing a continuous signal in amplitude and time. A sample-and-hold circuit samples the voltage of an analog signal and holds that voltage at a constant level. A quantizer then digitizes the sampled analog voltage by comparing it to a discrete set of digital levels. Many ADC architectures exist, employing multiple such stages in different configurations. Precise clock generation and distribution is required to synchronize all these components. And finally, DSP at the back-end corrects for distortions and mismatches.

Independent of the architecture, the performance of all ADCs can be compared through a handful of metrics. These include the sampling rate, nominal bit depth, signal-to-noise ratio (SNR), the signal-to-noise and distortion ratio (SNDR), and the spurious free dynamic range (SFDR) [31].

Discretizing in the time-domain can result in distortions of the signal. However, if the sampling rate is at least twice the largest frequency of the signal, the frequency domain information of the signal is accurately recovered. Satisfying this Nyquist criterion is critical for high-resolution digitization. Large sampling rates are therefore required to capture high-speed signals.

Discretization in the amplitude, however, leads necessarily to quantization error and distortion. This noise can be approximated to have a flat frequency distribution, with a total root mean square (RMS) noise power given by:  $Q/\sqrt{12}$  [32].  $Q$  is the difference between quantized voltage levels,  $Q = V_{FS}/2^N$ , where  $V_{FS}$  is the full scale voltage of the ADC and  $N$  is the nominal number of bits. For a signal that fills the full scale voltage of

the ADC, the SNR from nominal quantization noise is given by

$$SNR(dB) = 6.02 \times N + 1.76. \tag{1.1}$$

Because the quantization noise power is constant, and approximately spread flat across the full spectrum, increasing the sampling rate lowers the noise floor level. If the ADC over samples the signal, the digitized signal can be low pass filtered, effectively reducing quantization noise. Therefore, higher SNR is possible, for the same number of quantization levels, if we increase the sampling rate.

Additional error can arise in real-world situations. Electronic thermal noise and shot noise, plus sampling aperture jitter will all reduce the SNR with which analog signals are digitized. Additionally, distortions of the signal can accrue due to non-linearities in electronic switches and amplifiers, and timing mismatches in clock distribution. The SNDR is an important metric, which takes all these additional effects into account, defined as:

$$SNDR(dB) = 20 \times \log \left( \frac{Signal}{Noise + Distortion} \right). \tag{1.2}$$

The total effect of the additional noise and distortion is to reduce the effective number of bits with which the ADC quantizes an analog sample. Using Equation 1.1, the ENOB is therefore defined as

$$ENOB = \frac{SNDR(dB) - 1.76}{6.02}. \tag{1.3}$$

Together with the sampling rate, the ENOB is the most crucial metric used to characterize an ADC.

There exists an inverse relationship between analog bandwidth operation and ENOB of ADCs. Figure 1.2 illustrates this relationship by plotting state-of-the-art ADCs by their ENOB and analog bandwidths. Plotted along with the data are fundamental limitations due to thermal noise, aperture jitter, and comparator ambiguity. All of these limits scale inversely with bandwidth. The quantum limit is also plotted, based on the Heisenberg uncertainty relationship between energy and time, i.e. the voltage is quantum mechanically blurred over very short sampling times, fundamentally limiting our measurement accuracy.



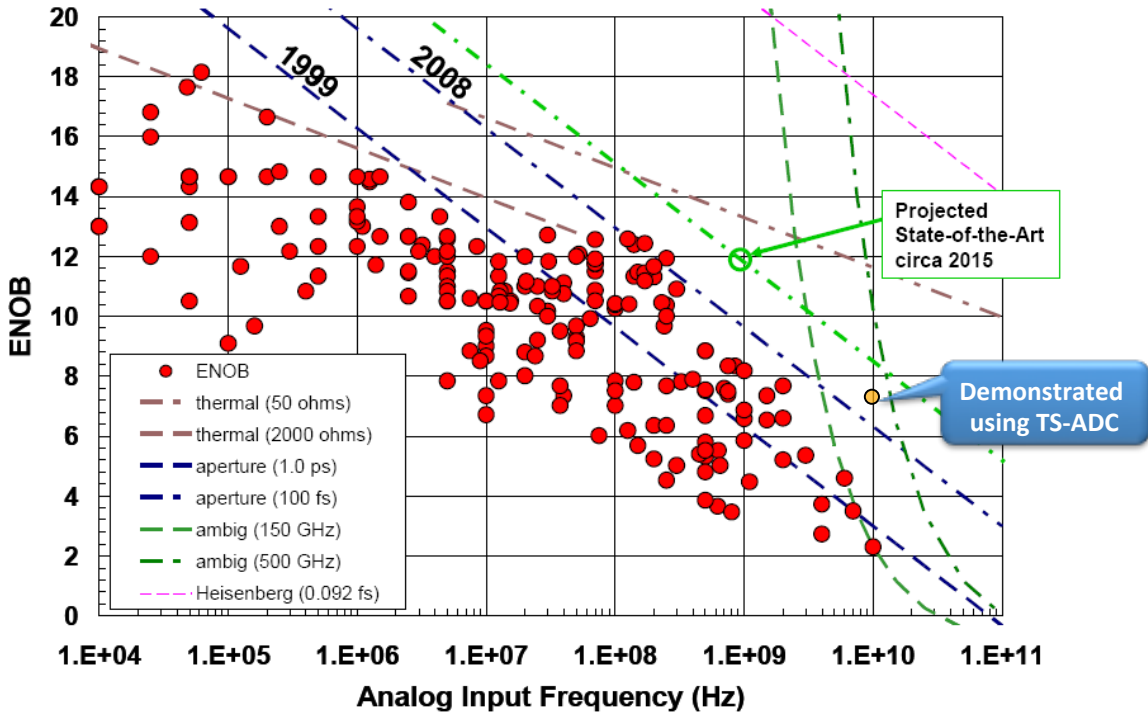

Figure 1.2: State-of-the-art ADCs, arranged based on their analog operating bandwidth and ENOB (Courtesy of reference [1]). Fundamental limits are plotted due to thermal noise, aperture jitter, and comparator ambiguity. The quantum limit is also plotted. I have added the results from the photonic time-stretch ADC as labeled.

SFDR is defined as the ratio of the RMS value of the signal to the RMS value of highest noise spur. SFDR can be quoted in dBc (decibels below the carrier), or dBFS (decibels below full scale). Spurs can exist in the digitized output of the ADC due to timing mismatches and spurious frequency sources. Non-linear distortion of an input signal also leads to spurs, which manifest at the harmonics of the signal. In addition to ENOB, SFDR is an important parameter for characterizing the dynamic range of an ADC.

### 1.2.1 Photonic time-stretch

From Figure 1.2, it is clear that capturing higher bandwidth signals comes with a necessary trade off in resolution. Sample interleaving architectures can overcome this limitation, by employing many lower bandwidth ADCs working in parallel. Each ADC samples the

same analog signal at a rate far under the Nyquist rate, but each samples the signal at a different time. The result is an ADC with a higher effective sampling rate and analog bandwidth. Though time-interleaving architectures can improve speeds and resolution of ADCs, mismatches between the individual ADCs plus excessive aperture jitter associated with aligning the many samples in time, invariably result in limited resolution [33].

The photonic time-stretcher (TiSER) [34, 35, 36, 37] is an alternative architecture, which also uses many lower speed, higher resolution ADCs in parallel. Instead of capturing successive samples with separate ADCs, TiSER slows down analog signals so that a single low speed ADC can capture long, continuous portions of the signal at a time (Fig. 1.3). TiSER thereby avoids the added aperture jitter associated with precisely synchronizing and aligning the clocks from many ADCs. By slowing down the analog signals before sampling, the effective aperture jitter is in fact reduced, thereby further improving resolution. Additionally, since oversampling distributes the quantization noise over a larger bandwidth, TiSER can overstretch analog signals to boost sampling rates and improve resolution. Added to Figure 1.2 is a TiSER system which achieved 45 dB SNDR (7.2 ENOB) and 52 dB SFDR over 10 GHz of analog noise bandwidth, a record for wideband digitization [38]. Additionally, using large stretch factors, enormous real-time sampling rates can be achieved, with previous demonstrations exceeding 10 TS/s using a 250 stretch factor [39].

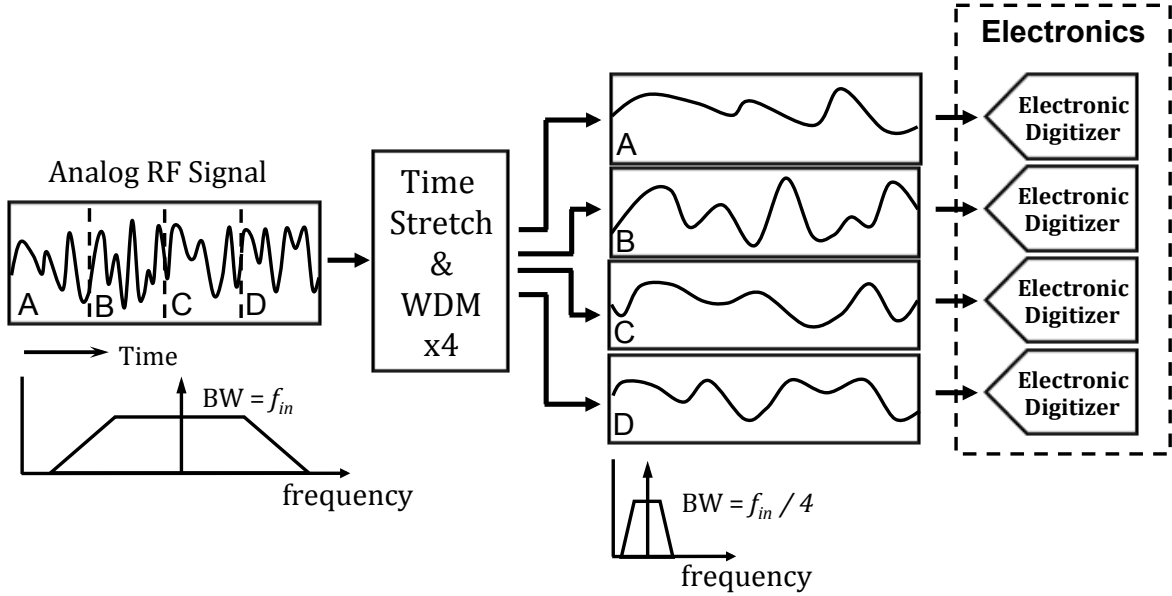

Figure 1.3: Photonic time-stretch slows down wideband analog signals, reducing their bandwidth, so that they can be captured by lower speed, higher resolution analog-to-digital converters.

TiSER is implemented using state-of-the-art mode-locked lasers (MLL), fiber optic components, and microwave photonic technology, leveraging the enormous investments being made in the telecommunications industry (Fig. 1.4). A pre-chirped optical pulse train is generated using a MLL and dispersive optics. The pulse-width is termed the time-aperture of TiSER. An electrical analog signal of interest is modulated onto this chirped broadband carrier using an electro-optic (EO) intensity modulator. The modulated pulses are then stretched in a long dispersive fiber, slowing down the analog signal. A photo-detector (PD) converts the stretched optical pulses back to the electrical domain, where they can be digitized by electronic ADCs. Finally, digital signal processing recovers the original analog signal.

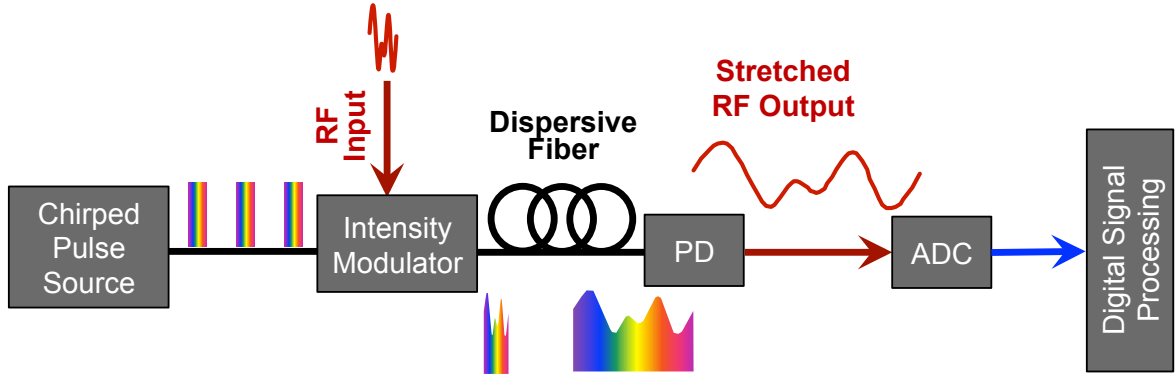

Figure 1.4: Schematic of TiSER. An analog RF input is modulated onto a pre-chirped broadband optical pulse train and stretched in a dispersive fiber resulting in a reduced bandwidth copy of the original signal. The optical signal is converted back to the electrical domain at the photodetector (PD). The signal is then digitized and processed by a real-time ADC and digital processor.

TiSER can be implemented in continuous time-fashion, as illustrated in Figure 1.3, by employing multiple ADCs and wavelength channels. Alternatively, TiSER can be implemented using only a single wavelength channel and one ADC. Though not a full receiver, the single channel version of TiSER can act as an oscilloscope [40]. The TiSER oscilloscope enables a new time of sampling modality termed real-time burst sampling. Windows of data are captured and sampled with very high sampling rates. The TiSER oscilloscope combines the real-time capabilities of real-time oscilloscopes and the large analog bandwidths of equivalent time oscilloscopes. The TiSER oscilloscope is very useful for analyzing repetitive signals, such as high-speed digital data, with high-throughput and high-fidelity. Additionally, because of its real-time capabilities, it is more capable of capturing rare events and characterizing non-Gaussian heavy tail distributions [29].

TiSER has no fundamental bandwidth limitation, with the potential to stretch wide-band analog signals ad infinitum. Additionally, TiSER can employ ever slower, higher resolution ADCs at the back-end, while reducing aperture jitter with increased stretching, thereby achieving higher ENOBs. There are, however, practical limitations to the bandwidth of TiSER, and distortions can arise due the time-stretching process.

EO modulators all have inherent bandwidth restrictions, due to the capacitive loads required to couple the RF signal to the optical carrier. Engineers are steadily pushing EO modulator technology to higher bandwidths, but recent trends in the market have slowed advances, leaving the state-of-the-art currently at  $\sim 100$  GHz [41]. Secondly, the time-stretch transformation inherently adds a quadratic phase on the spectrum of the slowed down analog signal, similar to dispersive fading common to all fiber optic links [42]. When the intensity is measured at the PD, the quadratic phase leads to interference at the PD. For double side-band modulated signals, the two side-bands destructively interfere, leading to frequency reduction. The effect places a limit on the time-bandwidth product (TBP) of TiSER, whereby an increase in the time-aperture leads to reduced bandwidth, and vice-versa. There are methods to overcome this dispersion penalty, employing single-side band modulation [36, 43] or phase-diversity with maximum ratio combining [44], but a truly general technique, which enables equalization of the dispersion induced phase for an arbitrary signal would be the ideal solution.

Non-linear distortions can also arise in TiSER, reducing the ENOB. The highest speed EO modulator technology, Mach-Zehnder modulators (MZMs), inherently impart a sinusoidal intensity mapping from the electrical domain to the optical domain, leading to harmonic distortion. Additionally distortion arises from non-linear squaring of the electric field at the PD. Digital signal processing can mitigate much of these distortions, enabling TiSER to achieve record setting ENOB and SFDR [38]. However, in order to continue advancing the resolution and bandwidth of time-stretch, additional optical and digital techniques are necessary.

In this thesis I discuss techniques, which I have developed to overcome some of the limitations in bandwidth and resolution mentioned above. In Chapter 2, I discuss in more detail pulse propagation in dispersive fibers and the time-stretch transformation. In Chapter 3, I present a method to double the spectral efficiency of TiSER using the additional polarization degree of freedom in optical fibers [45]. An all-optical modulation scheme is introduced in Chapter 4, which uses ultra-fast non-linear four-wave mixing to directly modulate an optical signal onto the pre-chirped optical pulse train [46]. With this all-optical technique,

we bypass the bandwidth limiting EO modulation, enabling ultra-wide bandwidth operation. In Chapter 5, I introduce the coherent dispersive Fourier transform, which is used in TiSER as a linear detector, with which I can recover the phase and amplitude of the time-stretched signal. This full-field recovery enables equalization of the dispersion induced phase, for a general signal input. This coherent TiSER also avoids non-linear distortion due to squaring of the electric field at the PD.

In (Chapter 6), I present applications of the TiSER system. In particular, experiments were performed in test-beds at the University of Southern California and at Columbia University, in which TiSER was used as a signal integrity monitor of high-speed optical data [47, 48]. In addition, I present preliminary simulations and discuss the potential for TiSER to be employed in wide-band instantaneous frequency measurements.

In the final chapter on time-stretch technology, (Chapter 7) I discuss my work in developing real-time digital signal processing at the back-end of TiSER using a field-programmable gate array (FPGA). By integrating the data capture and processing onto a single platform, we achieve very low processing latency and vastly increase the data handling capacity of TiSER. With a stretch factor of up to 100, we demonstrate an instantaneous sampling rate of 250 GS/s, and real-time digital processing throughput of 2 Tb/s.

### 1.3 High-speed Fluorescence Imaging

Fluorescence imaging is the most widely used method for unveiling the molecular composition of biological specimens. However, the weak optical emission of fluorescent probes and the tradeoff between imaging speed and sensitivity [49] is problematic for acquiring blur-free images of fast phenomena, such as sub-millisecond biochemical dynamics in live cells and tissues [50], and cells flowing at high speed [51]. The spatial resolution of modern fluorescence microscopy has been improved to a point such that sub-diffraction limited resolution is routinely possible [52]. However, the demand for continuous, sub-millisecond time resolution using fluorescence microscopy remains largely unsatisfied. Such a real-time fluorescence microscope would enable resolution of dynamic biochemical phenomena such

as calcium and metabolic waves in live cells [17, 18], action potential sequences in large groups of neurons [19, 20, 21], or calcium release correlations and signaling in cardiac tissue [22].

High-speed microscopy is also invaluable for imaging biological cells in flow. Flow cytometry is the ultimate technology for characterizing large populations of cells. By flowing cells single file at high speeds (up to 10 m/s), each cell can be interrogated individually, at rates in excess of 100,000 cells/s. Conventional flow cytometers employ single point laser interrogation, measuring either the forward and side scattered light, or a fluorescent signal. Single point measurements suffice for characterizing average distributions of large cell populations, but when searching for rare cells, they typically do not offer sufficient specificity [53]. Debris, clumps of cells, and non-specific labeling can all lead to large false positive rates. Multi-parameter techniques, such as multicolor fluorescent tagging [54] and high-speed imaging, in combination with forward and side scatter, can improve our ability to distinguish rare cells from the background. Flow imaging is additionally useful as it enables high-throughput morphology [51], translocation [55], and cell signaling [56] analysis quickly on large cell populations.

As fluorescence imaging frame rates increase towards the kHz range, the small number of photoelectrons generated during each exposure drops below the noise floor of conventional image sensors, such as the charge coupled device (CCD). The desire to perform high-speed, low-photon number imaging has been the primary driving force behind the development of the electron multiplying CCD (EMCCD) camera. EMCCDs use on-chip electronic gain to circumvent the high-speed imaging SNR problem. However, while EMCCDs can exhibit 1000-fold gain, the serial pixel readout strategy limits the full frame ( $512 \times 512$  pixels) rate to less than 100 Hz.

Due to their parallel readout architecture, scientific complementary metal-oxide-semiconductor (sCMOS) cameras exhibit low readout noise and pixel readout rates up to  $50\times$  higher than EMCCDs, including line scan readout rates of  $\sim 100$  kHz. However, the internal gain of EMCCDs ultimately makes them more attractive than sCMOS for the lowest light fluorescence imaging applications [2]. A comparison of the two imaging technologies is presented in

Figure 1.5. While both technologies are widely used in high-speed fluorescence microscopy, neither possesses a sufficient line readout rate to perform blur-free imaging of cells at the meter per second flow velocities typical of flow cytometry.

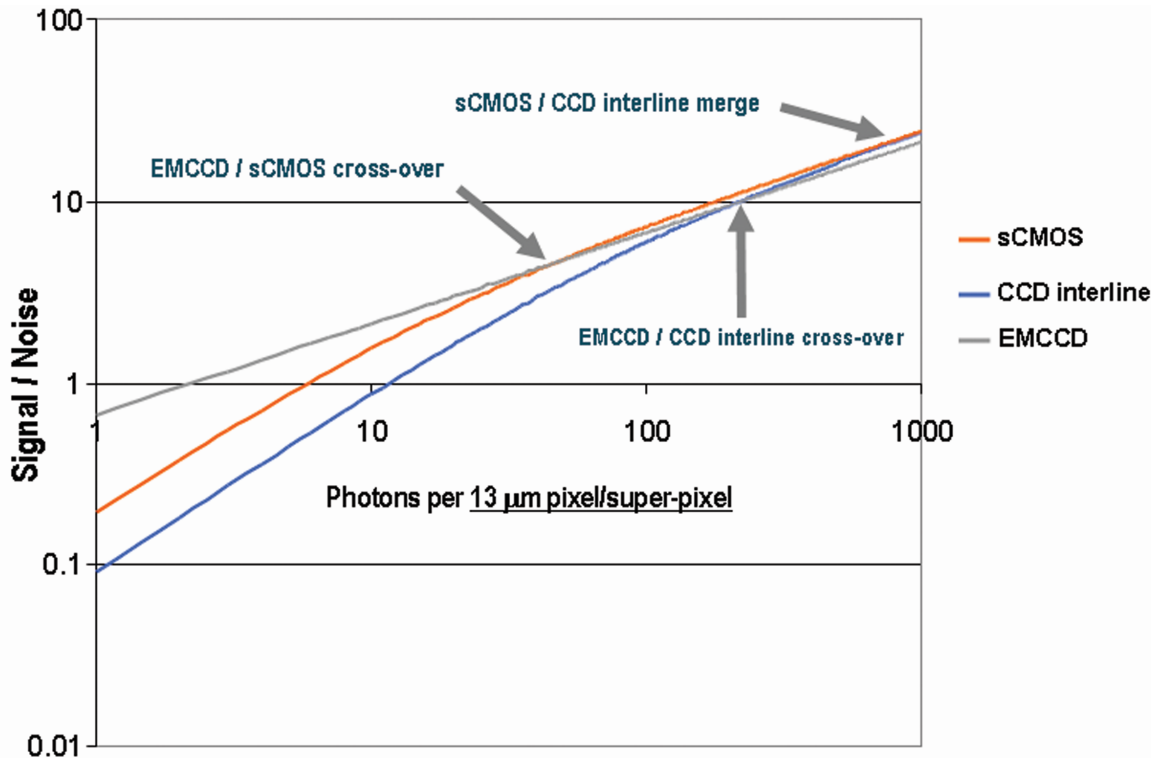

Figure 1.5: The state-of-the-art in high-speed, sensitive optical imaging are the EMCCD and sCMOS cameras. As illustrated here, EMCCDs provide superior SNR at the lowest photon levels, while sCMOS is the better technology for brighter samples. Courtesy of reference [2].

A photomultiplier tube (PMT) can provide  $1000\times$  higher gain,  $10\times$  lower dark noise, and  $50\times$  higher bandwidth than EMCCDs, but they are not typically manufactured in large array format. This limits the utility of PMTs in fluorescence microscopy to point-scanning applications, in which the speed of serial beam scanning limits the overall frame rate [57].

In Chapter 8, I introduce a new approach to high-speed fluorescence microscopy. Termed Fluorescence Imaging using Radio-frequency Tagged Emission (FIRE), this new approach employs orthogonal frequency division multiplexing (OFDM) techniques, borrowed from



the wireless communication field, to read out whole lines of pixels in parallel with a single-pixel PMT. FIRE combines the high-speed pixel rates of conventional CMOS technology, with the amplification capabilities and sensitivity of EMCCDs. Fire has already achieved record pixel and frame rate fluorescence imaging (250 Megapixels-per-second and 4.4 kHz) of stationary cells, as well as blur free image acquisition of cells in high-speed flow (1 m/s corresponding to 50,000 cells/s). Coupled with a real-time acquisition and processing electronic back-end, FIRE is the ideal tool for studying high-speed dynamics and detecting rare-phenomena.

## CHAPTER 2

### Photonic Time-Stretch: Fundamentals

In this chapter I discuss the fundamentals of photonics time-stretch. I begin with electromagnetic pulse propagation, deriving the origins of chromatic dispersion. The stationary phase approximation is used to examine the effects of large dispersion on optical pulses. I then go through the mathematics of time-stretch transformation. Finally, I discuss in detail the time-bandwidth product, electro-optic modulation, and the distortions that arise in time-stretching.

#### 2.1 Optical Pulse Propagation

Maxwell's equations govern the dynamics of the electromagnetic (EM) field in matter:

$$\nabla \cdot \mathbf{D}(\mathbf{r}, t) = \rho_f(\mathbf{r}, t) \quad (2.1a)$$

$$\nabla \cdot \mathbf{B}(\mathbf{r}, t) = 0 \quad (2.1b)$$

$$\nabla \times \mathbf{E}(\mathbf{r}, t) = -\frac{\partial \mathbf{B}(\mathbf{r}, t)}{\partial t} \quad (2.1c)$$

$$\nabla \times \mathbf{H}(\mathbf{r}, t) = \mathbf{J}_f(\mathbf{r}, t) + \frac{\partial \mathbf{D}(\mathbf{r}, t)}{\partial t} \quad (2.1d)$$

where  $\mathbf{E}$  and  $\mathbf{H}$  are the electric and magnetic fields,  $\mathbf{D}$  and  $\mathbf{B}$  are the the electric and magnetic flux densities, and  $\rho_f$  and  $\mathbf{J}_f$  are the free, unbounded charge and current densities - the sources of the EM field. I will use only MKS units in this thesis. The EM fields,  $\mathbf{E}$  and  $\mathbf{H}$ , are related to their corresponding flux densities,  $\mathbf{D}$  and  $\mathbf{B}$ , via the constitutive

relations

$$\mathbf{D}(\mathbf{r}, t) = \int_{-\infty}^t \varepsilon(\mathbf{r}, t - t') \cdot \mathbf{E}(\mathbf{r}, t') dt' \quad (2.2a)$$

$$\mathbf{B}(\mathbf{r}, t) = \int_{-\infty}^t \mu(\mathbf{r}, t - t') \cdot \mathbf{H}(\mathbf{r}, t') dt' \quad (2.2b)$$

where  $\varepsilon$  and  $\mu$  are the EM permittivity and permeability, which are in general tensorial parameters. Here we consider only the linear response of the material from the EM fields. The constitutive relations of Eq.(2.2a) assume spatially local interaction between the EM fields and flux densities but include temporally nonlocal interactions. However, to ensure causality, the flux densities can only depend on past EM fields. The permittivity and permeability  $\varepsilon(\mathbf{r}, t)$  and  $\mu(\mathbf{r}, t)$  must therefore vanish for  $t > 0$ . The convolution integrals in Eq. (2.2a) reflect this causality condition by terminating the upper limits of integration at time  $t$ .

We can equivalently consider the EM field in the frequency domain. Using the following definition of the Fourier transform:

$$F(t) = \frac{1}{2\pi} \int_{-\infty}^{\infty} \tilde{F}(\omega) \exp(-i\omega t) d\omega \quad (2.3a)$$

$$\tilde{F}(\omega) = \int_{-\infty}^{\infty} F(t) \exp(i\omega t) dt \quad (2.3b)$$

Maxwell's Equations and the constitutive equations from Eqs.(2.1) and (2.2a) are transformed to the frequency domain via

$$\nabla \cdot \tilde{\mathbf{D}}(\mathbf{r}, \omega) = \tilde{\rho}_f(\mathbf{r}, \omega) \quad (2.4a)$$

$$\nabla \cdot \tilde{\mathbf{B}}(\mathbf{r}, \omega) = 0 \quad (2.4b)$$

$$\nabla \times \tilde{\mathbf{E}}(\mathbf{r}, \omega) = i\omega \tilde{\mathbf{B}}(\mathbf{r}, \omega) \quad (2.4c)$$

$$\nabla \times \tilde{\mathbf{H}}(\mathbf{r}, \omega) = \tilde{\mathbf{J}}_f(\mathbf{r}, \omega) - i\omega \tilde{\mathbf{D}}(\mathbf{r}, \omega) \quad (2.4d)$$

$$\tilde{\mathbf{D}}(\mathbf{r}, \omega) = \tilde{\varepsilon}(\mathbf{r}, \omega) \cdot \tilde{\mathbf{E}}(\mathbf{r}, \omega) \quad (2.5a)$$

$$\tilde{\mathbf{B}}(\mathbf{r}, \omega) = \tilde{\mu}(\mathbf{r}, \omega) \cdot \tilde{\mathbf{H}}(\mathbf{r}, \omega). \quad (2.5b)$$

The above equations are applicable to an electromagnetic field in a general causal, linear material. However, in deriving the pulse propagation equations relevant to time-stretch, we can narrow our discussion to a very small subclass of materials. In particular, we consider optical pulse propagation in dielectric materials that are nonmagnetic,  $\tilde{\mu}(\mathbf{r}, \omega) = \mu_0$ , and which have no free sources,  $\tilde{j}(\mathbf{r}, \omega) = \mu_0$ . Furthermore, we can assume a permittivity which is a scalar quantity, independent of electric field orientation. Maxwell's equations are greatly simplified with these assumptions.

$$\nabla \cdot \left( \tilde{\varepsilon}(\mathbf{r}, \omega) \tilde{\mathbf{E}}(\mathbf{r}, \omega) \right) = 0 \quad (2.6a)$$

$$\nabla \cdot \tilde{\mathbf{H}}(\mathbf{r}, \omega) = 0 \quad (2.6b)$$

$$\nabla \times \tilde{\mathbf{E}}(\mathbf{r}, \omega) = i\omega\mu_0 \tilde{\mathbf{H}}(\mathbf{r}, \omega) \quad (2.6c)$$

$$\nabla \times \tilde{\mathbf{H}}(\mathbf{r}, \omega) = -i\omega\tilde{\varepsilon}(\mathbf{r}, \omega) \tilde{\mathbf{E}}(\mathbf{r}, \omega) \quad (2.6d)$$

where we have substituted in the constitutive relations. We can eliminate the magnetic field and arrive at

$$\nabla \times \nabla \times \tilde{\mathbf{E}}(\mathbf{r}, \omega) = \frac{\tilde{\varepsilon}(\mathbf{r}, \omega)}{\varepsilon_0} \frac{\omega^2}{c^2} \tilde{\mathbf{E}}(\mathbf{r}, \omega) \quad (2.7)$$

where  $\varepsilon_0$  is the vacuum permittivity, and  $c = 1/\sqrt{\mu_0\varepsilon_0}$  is the speed of light in vacuum. We can make one more simplifying assumption for the material. Typically, the permeability  $\tilde{\varepsilon}(\mathbf{r}, \omega)$  is spatially uniform, except for discrete discontinuities, as between the core and cladding in an optical fiber. In describing the electromagnetic fields inside the spatially uniform regions, we can ignore the spatial dependence of the permeability. Gauss's law is simplified to  $\nabla \cdot \left( \tilde{\varepsilon}(\mathbf{r}, \omega) \tilde{\mathbf{E}}(\mathbf{r}, \omega) \right) = \tilde{\varepsilon}(\omega) \nabla \cdot \tilde{\mathbf{E}}(\mathbf{r}, \omega) = 0$  and we have  $\nabla \times \nabla \times \tilde{\mathbf{E}}(\mathbf{r}, \omega) = \nabla \left( \nabla \cdot \tilde{\mathbf{E}}(\mathbf{r}, \omega) \right) - \nabla^2 \tilde{\mathbf{E}}(\mathbf{r}, \omega) = -\nabla^2 \tilde{\mathbf{E}}(\mathbf{r}, \omega)$ . Making the substitution into Eq.(2.7), we arrive at the Helmholtz equation

$$\nabla^2 \tilde{\mathbf{E}}(\mathbf{r}, \omega) + \frac{\tilde{\varepsilon}(\omega)}{\varepsilon_0} \frac{\omega^2}{c^2} \tilde{\mathbf{E}}(\mathbf{r}, \omega) = 0. \quad (2.8)$$

The Helmholtz equation can be solved to find the electric field, from which the magnetic field is uniquely determined.

We are interested in a solution to Equation 2.8 representing a guided EM wave with a well defined propagation direction and with relatively narrow bandwidth upshifted to a

high-frequency carrier. We also consider only transverse electric waves. An ansatz can thus be chosen:

$$\mathbf{E}(\mathbf{r}, t) = \hat{x} \{F(x, y)A(z, t) \exp(i\beta_0 z - i\omega_0 t)\}. \quad (2.9)$$

$A(z, t)$  is the pulse amplitude that we will be most concerned with. To solve for  $A(z, t)$ , we first take the Fourier transform of the ansatz

$$\tilde{\mathbf{E}}(\mathbf{r}, \omega) = \hat{x} \left\{ F(x, y) \tilde{A}(z, \omega - \omega_0) \exp(i\beta_0 z) \right\}. \quad (2.10)$$

and substitute into the Helmholtz equation, Equation 2.8. Introducing a new frequency dependent variable,  $k(\omega)$ , we are left with two equations

$$\nabla_t^2 F(x, y) + \left[ \frac{\tilde{\varepsilon}(\omega) \omega^2}{\varepsilon_0 c^2} - k^2(\omega) \right] F(x, y) = 0 \quad (2.11a)$$

$$2i\beta_0 \frac{\partial \tilde{A}(z, \omega - \omega_0)}{\partial z} + [k^2(\omega) - \beta_0^2] \tilde{A}(z, \omega - \omega_0) = 0 \quad (2.11b)$$

where we have ignored  $\frac{\partial^2 \tilde{A}}{\partial z^2}$  since the envelope varies much slower than the high-frequency carrier, per our assumption of narrow bandwidth. The transverse Helmholtz equation, Equation 2.11a, can be solved to determine the transverse spatial profile of the guided traveling wave. An expression for  $k(\omega)$  will be determined which must hold for a valid solution to the transverse Helmholtz equation. If we assume the wave number  $k(\omega)$  to be very nearly  $\beta_0$ , we can approximate  $k^2(\omega) - \beta_0^2$  as  $2\beta_0(k(\omega) - \beta_0)$ . From Equation 2.11b, the pulse amplitude then satisfies

$$\frac{\partial \tilde{A}(z, \omega - \omega_0)}{\partial z} = i[k(\omega) - \beta_0] \tilde{A}(z, \omega - \omega_0), \quad (2.12)$$

which can be integrated with respect to  $z$  to obtain the solution

$$\tilde{A}(z, \omega - \omega_0) = \tilde{A}(0, \omega - \omega_0) \exp \{i[k(\omega) - \beta_0] z\}. \quad (2.13)$$

The result of the propagation in the  $z$  direction acts to impart a frequency dependent complex phase on the pulse spectrum. If we consider the possibility of a complex wave number, we can split  $k(\omega)$  into its real and imaginary parts:  $k(\omega) = \beta(\omega) + i\alpha(\omega)/2$ . Substituting this expression into our solution for the pulse amplitude, Equation 2.13 becomes

$$\tilde{A}(z, \omega - \omega_0) = \tilde{A}(0, \omega - \omega_0) \exp \left\{ i[\beta(\omega) - \beta_0] z - \frac{\alpha(\omega)}{2} z \right\}. \quad (2.14)$$

$\beta(\omega)$  is termed the propagation constant, imparting pure complex phase, and  $\alpha(\omega)$  is termed the loss or absorption coefficient, attenuating the power with propagation. Because of the frequency dependence of the propagation constant,  $\beta(\omega)$ , different spectral components accumulate different phase shifts as the pulse propagates resulting in dispersion.

To study the effect of dispersion, we can use the fact that  $A(z, \omega - \omega_0)$  is localized around  $\omega_0$  and Taylor expand the propagation constant

$$\beta(\omega) = \sum_{n=0}^{\infty} \beta_n \frac{(\omega - \omega_0)^n}{n!} \quad (2.15a)$$

$$\beta_n \equiv \left( \frac{\partial^n \beta(\omega)}{\partial \omega^n} \right)_{\omega=\omega_0}. \quad (2.15b)$$

We can assign  $\beta_0$  from the original ansatz, Equation 2.9, to agree with the above,  $\beta_0 \equiv \beta(\omega_0)$ , such that substituting in the Taylor expanded propagation constant into our solution for the pulse amplitude, Equation 2.14, gives us

$$\tilde{A}(z, \omega - \omega_0) = \tilde{A}(0, \omega - \omega_0) \exp \left\{ i \left[ \beta_1(\omega - \omega_0) + \frac{1}{2} \beta_2(\omega - \omega_0)^2 + \dots \right] z - \frac{\alpha(\omega)}{2} z \right\}. \quad (2.16)$$

Each term in the Taylor expansion of  $\beta(\omega)$  leads to a different effect on the evolution of the pulse shape. The portion of the phase change which scales linearly with the frequency causes the pulse amplitude to travel at a group velocity  $v_g = 1/\beta_1$ . The portion of the phase change which scales with the square of the frequency leads to second order dispersion, or equivalently, linear group velocity dispersion (GVD). Conceptually, GVD is due to a varying slope of the propagation constant with respect to frequency, and therefore a group velocity which is dependent on frequency. The effect is that different spectral components of the pulse walk off from each other during propagation, spreading out the pulse in time.  $\beta_2$  is termed the dispersion parameter, with units of  $s^2/m$ . More practical units for the dispersion parameter would be  $ps/(nm \cdot km)$ , and we therefore define

$$D = -\frac{2\pi c}{\lambda^2} \beta_2 \quad (2.17)$$

with  $\lambda = \frac{2\pi c}{\omega_0}$ .

The higher order terms in the expansion of  $\beta(\omega)$ ,  $\beta_3, \beta_4, \dots$  lead to non-linear GVD, such that the group velocity of each spectral component scales non-linearly with frequency.

### 2.1.1 Origin of Dispersion

From the solution of the transverse Helmholtz equation, Equation (2.11a), we will obtain an equation for  $k(\omega)$  which must be satisfied. There are two origins of the frequency dependence of the expression for  $k(\omega)$ : (i) the frequency dependence of the EM permittivity,  $\tilde{\varepsilon}(\omega)$ , and (ii) the inherent frequency dependence of the Helmholtz equation. The first effect, dependence on  $\tilde{\varepsilon}(\omega)$ , is termed material dispersion, while the second, which is dependent on the boundary conditions and index of refraction profile, is termed the waveguide dispersion. The total dispersion is a contribution of the two.

The material dispersion can be studied by ignoring the transverse Laplacian in Equation 2.11a. We are left with a relation for  $k(\omega)$

$$k^2(\omega) = \frac{\tilde{\varepsilon}(\omega) \omega^2}{\varepsilon_0 c^2} \quad (2.18)$$

Writing the real and imaginary parts of the parameters in Eq.(2.18) we have

$$\left[ \beta(\omega) + i \frac{\alpha(\omega)}{2} \right]^2 = \left[ \frac{\text{Re} \{ \tilde{\varepsilon}(\omega) \}}{\varepsilon_0} + i \frac{\text{Im} \{ \tilde{\varepsilon}(\omega) \}}{\varepsilon_0} \right]^2 \frac{\omega^2}{c^2}. \quad (2.19)$$

If we make the approximation of low loss,  $\alpha(\omega) \ll \beta(\omega)$ , which is appropriate for propagation in fibers, we have  $\left[ \beta(\omega) + i \frac{\alpha(\omega)}{2} \right]^2 \approx \beta^2(\omega) + i \beta(\omega) \alpha(\omega)$  and we can solve for the propagation and loss parameters from Eq. (2.18) in terms of the real and imaginary parts of the EM permeability [58]

$$\beta(\omega) \approx \sqrt{\frac{\text{Re} \{ \tilde{\varepsilon}(\omega) \}}{\varepsilon_0}} \frac{\omega}{c} \equiv n(\omega) \frac{\omega}{c} \quad (2.20a)$$

$$\alpha(\omega) \approx \frac{\text{Im} \{ \tilde{\varepsilon}(\omega) \}}{\text{Re} \{ \tilde{\varepsilon}(\omega) \}} \beta(\omega) \quad (2.20b)$$

The Kramers-Kronig relations [58] give us the relationship between the real and imaginary parts of the electric permittivity. Following from the fundamental causality of the material response, these relations, along with Equation 2.20b, indicate an unavoidable loss associated with material dispersion. In order to increase the dispersion-to-loss ratio of dispersive elements, waveguide dispersion must therefore be exploited. Examples of large dispersive elements which utilize novel geometries to overcome the dispersion-to-loss limit

of material dispersion are dispersion compensating fibers and chromo-modal dispersive devices [59].

## 2.2 Stationary Phase Approximation

To study the effect of large dispersion on the pulse shape of a propagating optical pulse, we can invoke the stationary phase approximation when performing the inverse Fourier integral. The final result, as we will see, is to map the spectral profile of the pulse into the time domain.

Starting with the solution to the Helmholtz equation, Eq.(2.16), we can simplify by making a time transformation:  $t \rightarrow t - \beta_1 z = t - z/v_g$ . The effect in the frequency domain is to impart a phase,  $\exp[-i\beta_1(\omega - \omega_0)]$ , exactly canceling the corresponding term in Eq.(2.16). Conceptually, the transformation leads to us following the optical pulse at its average group velocity, such that we study exclusively changes in pulse shape. For the time-being we consider only linear GVD, ignoring higher order GVD and loss, and write the inverse Fourier integral for the pulse amplitude

$$\begin{aligned} A(z, t) &= \frac{1}{2\pi} \int_{-\infty}^{\infty} \tilde{A}(0, \omega) \exp \left[ i \left( \frac{1}{2} \beta_2 z \omega^2 - \omega t \right) \right] d\omega \\ &= \frac{1}{2\pi} \exp \left[ -i \frac{t^2}{2\beta_2 z} \right] \int_{-\infty}^{\infty} \tilde{A}(0, \omega) \exp \left[ i \frac{1}{2} \beta_2 z \left( \omega - \frac{t}{\beta_2 z} \right)^2 \right] d\omega. \end{aligned} \quad (2.21)$$

For large dispersion, the quadratic phase in Eq.(5.3) oscillates rapidly for frequencies  $\omega \neq t/(\beta_2 z)$ . Those portions of the integral will average to zero, and only the contribution from  $\omega = t/(\beta_2 z)$  will be of consequence. In this limit of large  $\beta_2 z$  we invoke the stationary phase approximation (SPA), which gives us

$$\lim_{\beta_2 z \rightarrow \infty} A(z, t) = \sqrt{\frac{i}{2\pi\beta_2 z}} \exp \left[ -i \frac{t^2}{2\beta_2 z} \right] \tilde{A} \left( 0, \frac{t}{\beta_2 z} \right). \quad (2.22)$$

Apart from a scale factor and a phase change quadratic in time, the result of large GVD is to map the spectral shape into the time domain. When viewed on a real-time oscilloscope,



after photo detection, the full system is equivalent to a single shot, high-speed optical spectrum analyzer [60]. We call this phenomenon optical dispersive Fourier transformation (ODFT).

The ability to resolve very sharp spectral features depends on the amount of GVD used. With finite  $\beta_2 z$ , spectral components of frequencies close to  $\omega = t/(\beta_2 z)$  will contribute to the integral at the same point in time, blurring out the spectrum-to-time mapping. The resolution of ODFT is given by [61]

$$\Delta\omega = 2\sqrt{\frac{\pi}{\beta_2 z}}. \quad (2.23)$$

## 2.3 Photonic Time-Stretch

In this section I present the mathematical framework of photonic time-stretch.

We start with an optical pulse, with electric field profile given by  $A_0(t)$ . The pulse must be broadband and have a flat spectral shape. This will become clear as we proceed with the derivation.

The first step in the PTS process is pre-chirping via second-order dispersion in the first fiber. A quadratic phase is imparted on the electric field in the frequency domain (Eq. 2.21):

$$\tilde{A}_{D1}(\omega) = \tilde{A}_0(\omega) \left[ i\frac{1}{2}\beta_2 L_1 \omega^2 \right], \quad (2.24)$$

where  $\beta_2$  is the dispersion parameter of the fiber and  $L_1$  is the length of the first fiber.

The next step in the PTS process is the modulation of a time-domain signal onto the pre-chirped pulse,  $A_{D1}(t)$ . We consider a general input signal  $s(t) \leftrightarrow \tilde{s}(\omega_{RF})$ . We have written the frequency variable as  $\omega_{RF}$  to highlight that the modulated signal must be in the RF domain ( $< 100GHz$ ), as compared to the optical domain of the time-stretch pulse ( $\sim 2THz$  bandwidth around  $200THz$ ). We model modulation as a multiplication in the time domain, independent of the modulation mechanism. The time-stretch pulse electric field profile becomes

$$A_m(t) = A_{D1}(t)s(t). \quad (2.25)$$

Because multiplication in the time-domain corresponds to convolution in the frequency domain, we have the Fourier transform of the modulated pulse given by

$$\tilde{A}_m(\omega) = \frac{1}{2\pi} \int_{-\infty}^{\infty} \tilde{s}(\omega_{RF}) \tilde{A}_{D1}(\omega - \omega_{RF}) d\omega_{RF}. \quad (2.26)$$

Time-stretching occurs by dispersing the modulated optical pulse in a second dispersion step:

$$\tilde{A}_{D2}(\omega) = \tilde{A}_m(\omega) \exp \left[ i \frac{1}{2} \beta_2 L_2 \omega^2 \right], \quad (2.27)$$

with  $L_2$  the length of the second fiber.

Upon substituting Equations (2.24,2.25,2.26) into Equation (2.27) we have

$$\tilde{A}_{D2}(\omega) = \frac{1}{2\pi} \int_{-\infty}^{\infty} \tilde{s}(\omega_{RF}) \tilde{A}_0(\omega - \omega_{RF}) \exp \left[ i \frac{1}{2} \beta_2 L_1 (\omega - \omega_{RF})^2 + i \frac{1}{2} \beta_2 L_2 \omega^2 \right] d\omega_{RF}. \quad (2.28)$$

We can rearrange the argument of the exponent as follows:

$$L_1(\omega - \omega_{RF})^2 + L_2\omega^2 = \left( \omega - \frac{\omega_{RF}}{M} \right)^2 (L_1 + L_2) + \frac{L_2}{M} \omega_{RF}^2, \quad (2.29)$$

where we have introduced the stretch factor  $M = \frac{L_2}{L_1} + 1$ . We can rewrite Equation (2.28) as

$$\tilde{A}_{D2}(\omega) = \frac{1}{2\pi} \int_{-\infty}^{\infty} \tilde{s}(\omega_{RF}) \exp \left[ i \frac{1}{2} \frac{\beta_2 L_2}{M} \omega_{RF}^2 \right] \tilde{A}_0(\omega - \omega_{RF}) \exp \left[ i \frac{1}{2} \beta_2 L_{tot} \left( \omega - \frac{\omega_{RF}}{M} \right)^2 \right] d\omega_{RF} \quad (2.30)$$

with the total length of fiber defined as  $L_{tot} \equiv L_1 + L_2$ .

To simplify Eq.(2.30) we must make our first assumption on the time-stretch pulse. Let us consider the case where  $\tilde{s}(\omega_{RF})$  vanishes above a maximum RF frequency  $\omega_{RF}^{max}$ . This is a reasonable assumption as the RF driving electronics and modulation mechanism have a finite bandwidth. In cases where an electro-optic modulator is used,  $\omega_{RF}^{max}$  is typically less than 100GHz. The limits on the convolution integral in Equation (2.30) therefore effectively span  $-\omega_{RF}^{max}$  to  $+\omega_{RF}^{max}$ . If the spectral intensity  $\tilde{A}_0(\omega)$  is constant over a range of  $2\omega_{RF}^{max}$ , for all  $\omega$ , then we are justified in approximating  $\tilde{A}_0(\omega - \omega_{RF})$  as simply  $\tilde{A}_0(\omega)$ . Or, we can make the approximation:  $\tilde{A}_0(\omega - \omega_{RF}) \approx \tilde{A}_0(\omega - \frac{\omega_{RF}}{M})$ . This assumption on the spectral intensity of the time-stretch pulse requires an optical bandwidth ( $\Delta\omega > 1THz$ )

and a smooth spectral shape. We can ensure this requirement is satisfied by choosing an appropriate time-stretch pulse source, such as from a stable, inhomogeneously broadened mode-locked laser.

Making the above approximation, and taking the Fourier transform of Eq.(2.30) gives us the final time-domain electric field profile after time-stretching:

$$A_{D2}(t) = \left( \frac{1}{2\pi} \int_{-\infty}^{\infty} \tilde{A}_0(\omega) \exp \left[ i \frac{1}{2} \beta_2 L_{tot} \omega^2 - i \omega t \right] d\omega \right) \times \left( \frac{1}{2\pi} \int_{-\infty}^{\infty} \tilde{s}(\omega_{RF}) \exp \left[ i \frac{1}{2} \frac{\beta_2 L_2}{M} \omega_{RF}^2 - i \frac{\omega_{RF}}{M} t \right] d\omega_{RF} \right) \quad (2.31a)$$

$$\equiv A_{env}(t) s_M(t). \quad (2.31b)$$

As we can see, the final profile consists of the the original pulse,  $A_0(t)$ , but dispersed such that the spectrum is mapped to the time domain through ODFT,  $A_{env}(t) \propto \tilde{A}_0(\omega = t/\beta_2 L)$ , via Equation 2.22. Modulated on this spectral envelope is a transformed version of the original analog signal,  $s_M(t)$ . As can be seen in the second line of Equation 2.31a, the spectral components of  $s_M(t)$  are those of the original signal,  $\tilde{s}(\omega_{RF})$ , with a dispersion induced phase,  $\phi_{DIP} = \frac{1}{2} \frac{\beta_2 L_2}{M} \omega_{RF}^2$

$$s_M(t) = \frac{1}{2\pi} \int_{-\infty}^{\infty} \tilde{s}(\omega_{RF}) \exp \left[ i \phi_{DIP}(\omega_{RF}) - i \frac{\omega_{RF}}{M} t \right] d\omega_{RF}. \quad (2.32)$$

However, most importantly, each spectral component,  $\tilde{s}(\omega_{RF}) \exp(i\phi_{DIP})$ , is mapped to a lower frequency,  $\frac{\omega_{RF}}{M}$ . The original spectral information is in tact, but condensed to a smaller bandwidth. The signal has been time-stretched.

## 2.4 Electro-optic Modulation

Mapping an analog electrical signal into the optical domain requires an interaction between the two electric fields. Such interactions are inherently weak, relying on non-linear phenomena. The fastest and most efficient modulation technology are electro-absorption modulators (EAMs) and Mach-Zehnder Modulators (MZMs).

Electro-absorption modulators (EAMs) take advantage of the Franz-Keldysh effect, in which an induced voltage in a semiconductor material alters the optical absorption coefficient. EAMs can achieve large bandwidths (up to 80 Gb/s [62]), but suffer from reduced wavelength dependent absorption, limited modulation depth, and limited optical power handling capabilities [11].

MZMs rely on the Pockel's effect, by which an induced voltage across a crystal linearly changes the refractive index [63]. The effect on a propagating optical signal is a voltage dependent phase shift. An MZM employs one or two such phase shifters, configured in a Mach-Zehnder interferometer. The interference of the phase modulated signals at the output of the MZM results in an amplitude modulated signal. Using two phase shifters, driven with opposite phases, improves the efficiency of the modulation. MZMs boast minimal wavelength-dependent modulation characteristics, can reach extinction ratios exceeding 20 dB, and feature lower insertion loss than EAMs [11].

The maximum RF bandwidth of MZMs is limited by the RC time constant of the capacitors applying the voltage across the crystal. By using an RF waveguide, in which the RF signal travels down the the length of the crystal with the light, the RC time-constant limit can be broken. For these traveling wave MZMs, the RF bandwidth limit then is determined by the RF waveguide dispersion, which leads to mismatch between the phase velocity of the RF signal and the group velocity of the light. In TiSER we almost exclusively employ dual-drive, traveling wave, Lithium niobate (LiNbO<sub>3</sub>) MZMs, with RF bandwidths of 40+ GHz.

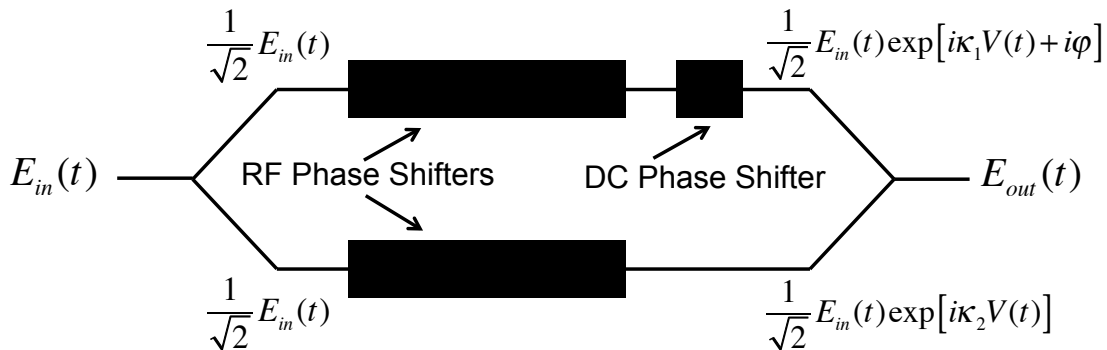

Figure 2.1: Schematic of a dual-drive Mach-Zehnder modulator.

A dual drive MZM is illustrated in Figure 2.1. An input electric optical field is split in a 50-50 coupler and sent to two RF phase shifters. The two phase shifters are driven by the same voltage signal  $V(t)$ , but impart different phase shifts based on the modulation constants,  $\kappa_{1,2}$ . An additional DC phase shifter acts on one of the arms to adjust the overall phase delay between the two arms. Upon interference at the the output, the electric field,  $E_{out}$  is given by

$$\begin{aligned} E_{out}(t) &= E_{in}(t) \frac{1}{2} \{ \exp [i\kappa_1 V(t) + i\varphi] + \exp [i\kappa_2 V(t)] \} \\ &= E_{in}(t) \cos \left[ \frac{\varphi}{2} + \left( \frac{\kappa_1 - \kappa_2}{2} \right) V(t) \right] \exp \left[ i \frac{\varphi}{2} + i \left( \frac{\kappa_1 + \kappa_2}{2} \right) V(t) \right]. \end{aligned} \quad (2.33)$$

In an ideal MZM, the two arms are perfectly matched, but with opposite signs, i.e.  $\kappa_1 = -\kappa_2$ . In such a case, Eq. (2.33) becomes

$$E_{out}(t) = E_{in}(t) \cos \left( \frac{\varphi}{2} + \kappa V(t) \right) \exp \left( i \frac{\varphi}{2} \right). \quad (2.34)$$

Although the phase modulation may be linear, the interference pattern of Eq. (2.35) leads to a non-linear sinusoidal modulation transfer function (Fig. 2.2). By tuning the DC bias,  $\varphi = \pi/2$ , to 50% modulation point, termed the quadrature point, and by maintaining an appropriately limited voltage range, we can achieve approximately linear modulation (gray region in Figure 2.2). The output electric field, ignoring the overall phase shift, is therefore given by

$$E_{out}(t) = E_{in}(t) \cos \left( \frac{\pi}{4} + \frac{m}{2} V(t) \right), \quad (2.35)$$

where  $m = \pi V_{RF}/V\pi$  is termed the modulation depth, with  $V_{RF}$  the amplitude of the voltage signal ( $|V(t)| \leq 1$ ), and  $V\pi$  the voltage range corresponding to a 100% swing optical transmission (Fig.(2.2)).

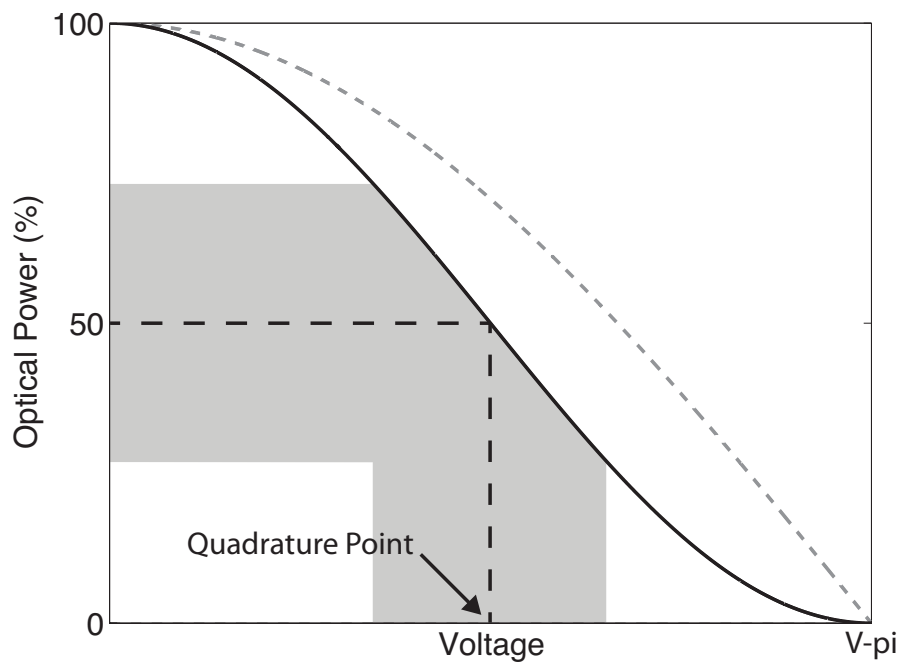

Figure 2.2: Sinusoidal modulation transfer function typical of a MZM. The gray region centered at the quadrature point indicates the approximately linear operating region.

Although there is a region at which the modulation is approximately linear, the MZM is inherently a non-linear device, and leads to higher-order side bands. These distort the signal and, when used in TiSER, limit the resolution with which the system can recover the original analog signal.

## 2.5 Non-linear Distortion in Time-stretch

We can analyze the effects of the non-linear transfer function of the MZM (Eq. 2.35) by considering a single tone input signal:

$$s(t) = \cos\left(\frac{\pi}{4} + \frac{m}{2} \cos \omega_{RF} t\right). \quad (2.36)$$

The spectral components of  $s(t)$  in Equation 2.36 are determined using the Jacobi-Anger expansion:

$$s(t) = \frac{\sqrt{2}}{2} \sum_{n=-\infty}^{\infty} c_n J_n \left( \frac{m}{2} \right) \exp(-in\omega_{RF}t) \quad (2.37)$$

with

$$c_n = \begin{cases} (-1)^{n/2} & \text{if } n \text{ even} \\ (-1)^{n+1/2} & \text{if } n \text{ odd,} \end{cases}$$

such that

$$\tilde{s}(\omega) = \frac{\sqrt{2}}{2} \sum_{n=-\infty}^{\infty} c_n J_n \left( \frac{m}{2} \right) \delta(\omega - n\omega_{RF}). \quad (2.38)$$

As we see, the signal contains all harmonics of the single tone input, due to the non-linear modulation.

After time-stretching, the signal is determined from Equation 2.32

$$s_M(t) = \frac{\sqrt{2}}{2} \sum_{n=-\infty}^{\infty} c_n J_n \left( \frac{m}{2} \right) \exp \left[ i\phi_{DIP}(n\omega_{RF}) - in\frac{\omega_{RF}}{M}t \right]. \quad (2.39)$$

All the spectral harmonics are mapped to lower frequencies due to time-stretching, and accumulate the dispersion induced phase. If we were to recover this complex signal using linear coherent detection, we could equalize the dispersion penalty and perform the inverse of the MZM transfer function, thereby recovering the original single-tone signal. However, when direct detection is employed, a PD measures the intensity of the electric field. The detected current is given by:

$$I(t) \propto |A_{env}(t)|^2 |s_M(t)|^2. \quad (2.40)$$

By using the approximation:  $J_n(m) \approx (1/2^n n!) m^n$ , we can expand  $|s_M(t)|^2$  in Equation 2.39, and keeping terms with lowest order in  $m$  we have

$$|s_M(t)|^2 = 1 - m \cos \phi_{DIP} \cos \frac{\omega_{RF}}{M}t \quad (2.41)$$

$$+ \frac{m^2}{8} (1 - \cos 4\phi_{DIP}) \cos 2\frac{\omega_{RF}M}{t} \quad (2.42)$$

$$+ \frac{m^3}{96} (\cos 9\phi_{DIP} + 3 \cos 3\phi_{DIP}) \cos 3\frac{\omega_{RF}}{M}t \quad (2.43)$$

+ ...

The first line of Equation 2.41 gives us the desired single-tone time-stretched signal. The subsequent lines contribute to non-linear distortion of the signal.

## 2.6 Dispersion Penalty and Time-Bandwidth Product

The dispersion induced phase

$$\phi_{DIP}(\omega_{RF}) = \frac{1}{2} \frac{\beta_2 L_2}{M} \omega_{RF}^2. \quad (2.44)$$

is equivalent to that which would be imparted on the signal if it were dispersed by a fiber of length  $L_2/M$ . It is not that the fiber is shorter, but that the frequency of the signal decreases as it is stretched, so the total dispersion induced phase is reduced. However, it still imparts a bandwidth limiting dispersion penalty to our time-stretched signal upon detection, as seen in the first line of Equation 2.41. For a double sideband modulated signal the transfer function is given by  $H_{DIP}(\omega_{RF}) = \cos(\phi_{DIP}(\omega_{RF}))$ . Effectively, the dispersion penalty acts to low pass filter our time-stretched signal. Conceptually, this occurs because the two side-bands accrue different phase shifts as they propagate down the dispersive fiber. Upon interference at the PD, the phase shift leads to destructive interference. The 3-dB point of the dispersion penalty low pass filter occurs at  $\Delta\omega_{RF} = \sqrt{\frac{\pi}{2} \frac{M}{\beta_2 L_2}} \approx \sqrt{\frac{\pi}{2} \frac{1}{\beta_2 L_1}}$  where we have approximated  $M \approx L_2/L_1$ , which is valid for large M.

The time-aperture is defined as the pulse width after the first dispersive fiber, equivalent to the amount of time that each pulse captures data:  $T_A = \beta_2 L_1 \Delta\omega_{opt}$ , where  $\Delta\omega_{opt}$  is the optical bandwidth of the time-stretching pulse. The time-bandwidth product is defined as  $TBP = 2T_A \Delta\omega_{RF}$ . With a double sideband modulated signal, the time-bandwidth product of time-stretch is limited to

$$TBP_{DSB} = \frac{\Delta\omega_{opt}}{2\Delta\omega_{RF}}. \quad (2.45)$$

To overcome this limitation two techniques exist. Since the dispersive fading phenomenon arises from interference of the two sidebands, single sideband modulation can be used to avoid this effect [36, 43]. The second technique, termed phase diversity, uses maximum ratio combining of two outputs from a MZM, which have inherently complemen-



tary transfer functions [44]. However, there is as yet no general technique to mitigate the dispersion penalty for an arbitrarily modulated input.

## CHAPTER 3

# Doubling the Spectral Efficiency of Time-Stretch with Polarization Multiplexing

A crucial feature of photonic time-stretch (TiSER) is the spectral efficiency, i.e. the optical bandwidth required to capture a certain time aperture of an RF signal over sufficient RF bandwidth. It is naturally desirable to maximize the time aperture so that more of the signal is captured. In addition, a larger capture window results in improved frequency resolution when analyzing the RF spectra of analog signals. The time-bandwidth product, equal to the time-aperture times the 3-dB RF bandwidth due to dispersion penalty, is proportional to the optical bandwidth (Eq. 2.45). The TBP achieved for a particular optical bandwidth is the spectral efficiency of TiSER. In this chapter, I introduce the dual-polarization photonic time-stretcher (DP-TiSER), which exploits polarization multiplexing in the TiSER system to double the spectral efficiency [45]. DP-TiSER maps two consecutive segments of the RF signal onto two orthogonal polarization states and multiplexes them on a single-wavelength channel. The result is a doubling of the effective time-bandwidth product for a constant optical bandwidth. This technique can also be used in the TiSER oscilloscope to significantly increase the record length and hence, the sampling throughput.

### 3.1 Introduction

The time aperture of the TiSER system is equal to the width of the optical pulse after the first dispersive fiber, given by  $T_A = \Delta\lambda D_1$ , where  $\Delta\lambda$  is the optical bandwidth and  $D_1$  is the initial dispersion. When double side-band modulation (DSB) is employed to modulate the RF signal onto the pre-chirped pulse, a frequency-fading phenomenon due

to dispersion [36], i.e. dispersion penalty, is inevitable. The overall effect is to limit the effective 3-dB RF bandwidth of the TiSER to an expression dependent on the inverse square root of the initial dispersion:  $\Delta f_{RF} = [1/(8|\beta_2|L_1)]^{1/2}$ , where  $\beta_2$  is the group-velocity dispersion (GVD) parameter. Hence, for a certain desired RF bandwidth, a limit is placed on the maximum pre-dispersion that can be tolerated, at which point, to increase the time aperture, one must use time-stretching pulses with larger optical bandwidth. Alternatively stated, the product of the time aperture and RF bandwidth, a figure of merit termed the time-bandwidth product (TBP), depends linearly on optical bandwidth (Eq. 2.45) [64]:

$$TBP = \frac{\Delta\omega_{opt}}{2\Delta\omega_{RF}}. \quad (3.1)$$

In order to meet the increasing RF bandwidth demands of modern applications, the TiSER system must therefore employ broadband optical pulses with larger optical bandwidth, straining the capabilities of the SC source, and eventually leading to undesired distortions, such as wavelength-dependent loss and optical nonlinearity. Improving the spectral efficiency of the TiSER system equates to increasing the TBP independent of optical bandwidth, so that large RF bandwidth demands can be met feasibly and efficiently.

TiSER effectively utilizes the optical spectrum to its advantage. However, the optical polarization is an additional degree of freedom to be used to increase the information capacity of a fiber optic link. Dual-polarization multiplexing is used extensively in modern optical communication networks to achieve enormous data rates. We can similarly use polarization multiplexing to double the information captured and stretched by TiSER. As illustrated in Figure 3.1, we separate each pre-chirped optical pulse into orthogonal polarization states. We can stagger them in time by adding relative delays. The two pulses capture adjacent windows of the same analog signal thereby doubling the total capture window for the same optical bandwidth.

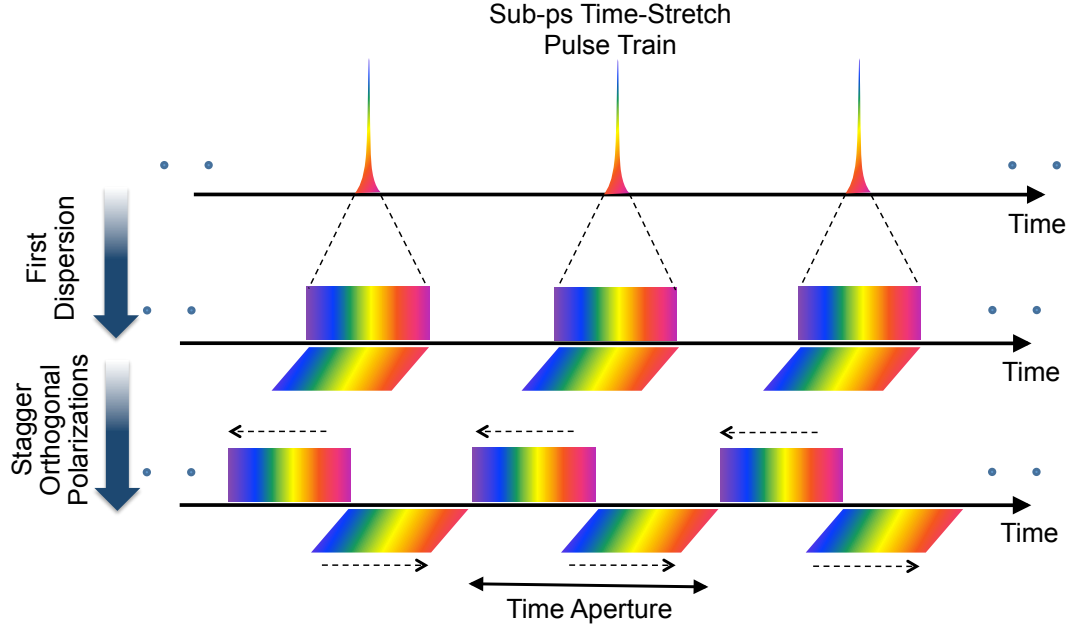

Figure 3.1: By staggering two orthogonally polarized pre-dispersed time-stretch pulses, we can double the time-aperture of TiSER for the same optical bandwidth. The result is a doubling of the time-bandwidth product.

### 3.2 Prototype System

The DP-TiSER uses a mode-locked laser (MLL) followed by a highly nonlinear fiber (HNLF) to generate the broadband optical pulses as illustrated in Figure (3.2). The pulses are chirped using a spool of dispersion compensating fiber (DCF) with total dispersion value of  $-41\text{ps/nm}$ . The pre-chirped optical pulses are polarized and split into two orthogonally polarized pulse trains via a polarization beam splitter. A polarization controller before the polarization beam splitter is adjusted to ensure equal amplitudes in the two channels upon detection.

A delay line in one of the arms staggers the two orthogonally polarized pulse trains, leaving a small region of overlap. They are then modulated by the same RF signal in two dual-output push-pull Mach-Zehnder modulators. Due to the time skew, the two corresponding pulses capture two consecutive segments of an RF signal, doubling the time

aperture.

The complementary outputs of the modulators are used to perform differential operation for 2nd order distortion cancellation. To avoid mismatch between the signal paths of the complementary outputs, the complementary pulse trains are multiplexed in time onto the same polarization state. Polarization controllers at each output are used to align the polarizations. The pulses from the complementary outputs are delayed relative to each other by approximately half the pulse period to avoid overlap after stretching.

The orthogonally polarized pulse trains from the two modulators are overlapped in time by a second delay line in one of the arms and then separately amplified using two C-band erbium doped fiber amplifiers (EDFA). The two signals are then polarization multiplexed in a polarization beam combiner. The polarization multiplexed optical pulse trains are stretched using total dispersion of  $-606\text{ps/nm}$  to achieve stretch factor of  $\sim 16$ .

In order to mitigate the crosstalk between the polarization channels due to polarization mode dispersion (PMD), a double-pass configuration consisting of a spool of DCF with total dispersion value of  $-303\text{ps/nm}$ , circulator, and faraday mirror was used. After dispersion, the polarization multiplexed signals are demultiplexed via a polarization beam splitter. The useful portion of the optical bandwidth ( $\sim 20\text{nm}$ ) around  $1551\text{nm}$  is filtered, and the stretched optical pulses are detected using two photodetectors. The obtained RF signals are digitized by a  $16\text{ GHz}$  real-time oscilloscope with  $50\text{GS/s}$  sampling rate (Tektronix-DPO71604).

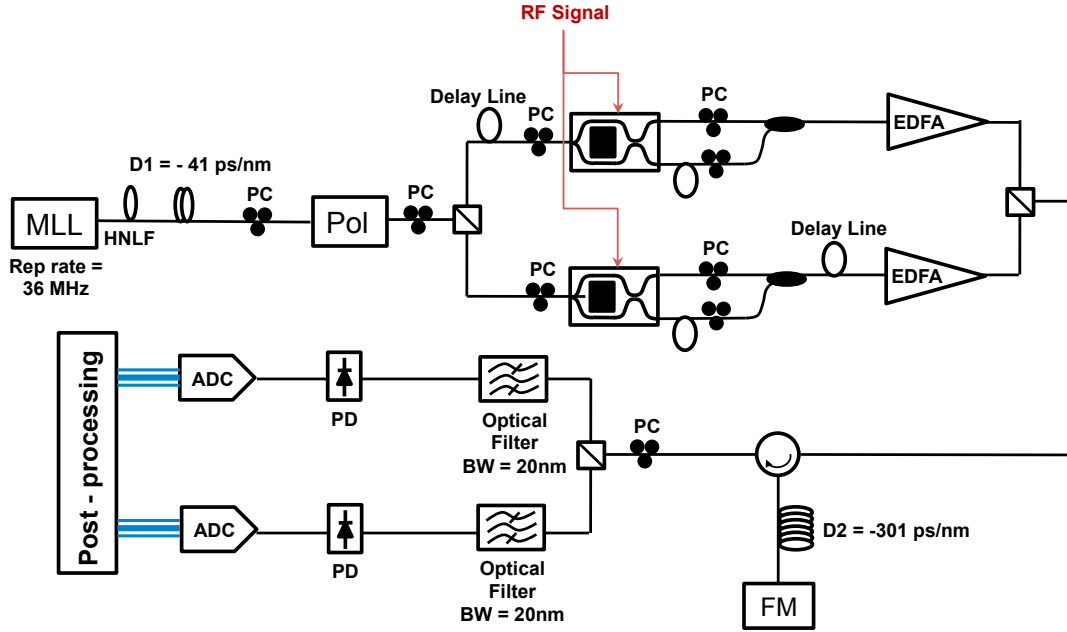

Figure 3.2: Schematic of the dual-polarization photonic time-stretcher (DP-TiSER). MLL: Mode-locked laser, HNLF: Highly non-linear fiber, PC: Polarization controller, Pol: Polarizer, EDFA: Er-doped fiber amplifier, FM: Faraday mirror, PD: Photodetector. In order to mitigate the crosstalk between the polarization channels while stretching in the DCF, we used a double-pass configuration, using an optical circulator and a Faraday mirror.

Digital signal processing is performed offline for correcting nonlinear distortions such as 2nd order distortion due to dispersion, time-warps, and 3rd order distortion due to the Mach-Zehnder modulator [65]. We applied a 1.1GHz low-pass filter in digital signal processing, to filter out out of band quantization noise, improving our SNR. The DP-TiSER preprocessor demonstrated here achieves an effective time aperture of  $2 \cdot 41\text{ps/nm} \cdot 20\text{nm} = 1.64 \text{ ns}$ .

### 3.3 Performance Results

To demonstrate the functionality of the DP-TiSER preprocessor, we performed a single-tone test at 6 GHz and a two-tone test at 8.2 GHz and 10.25 GHz as shown in figure (3.3). After distortion corrections, the captured segments of each polarization channel are stitched in the digital domain to verify the increase in the effective time aperture. The power spectrum of the RF signal is calculated after stitching more than 300 consecutive segments. The single-tone (Fig. 3.3a) and two-tone (Fig. 3.3b) tests show 6.1-6.3 and 5-5.1 effective number of bits (ENOBs) respectively over 10 GHz instantaneous noise bandwidth. These results showcase the high-resolution recording of wide-band RF signals using this system.

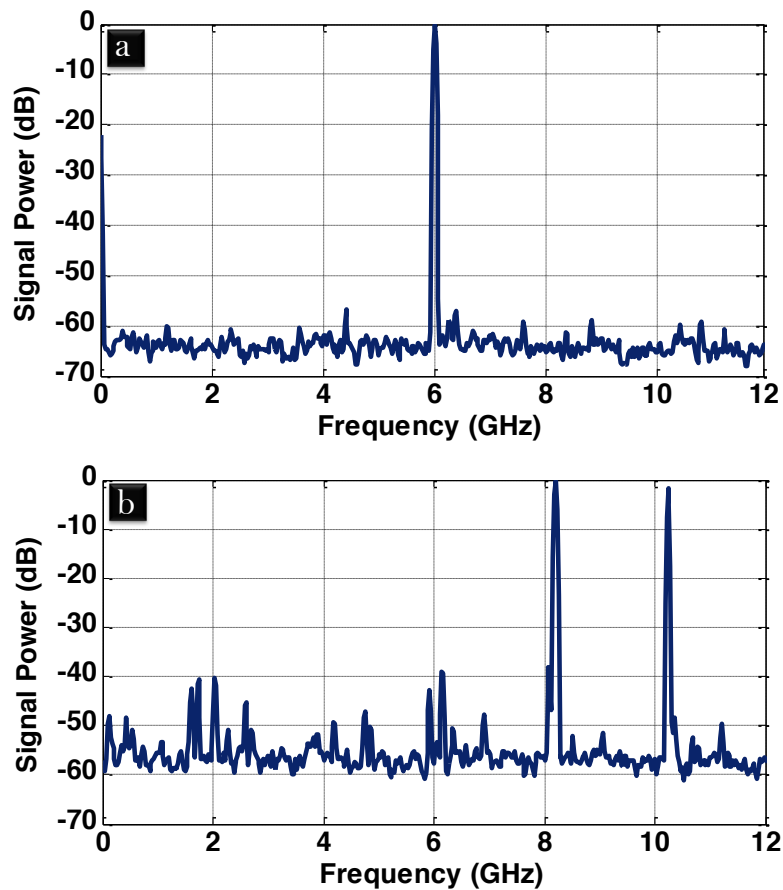

Figure 3.3: (a) Single-tone test with 6 GHz RF signals; (b) two-tone test with 8.2 GHz and 10.25 GHz RF signals. More than 600 segments (300 segments per polarization channel) are stitched coherently to generate these plots.

In order to demonstrate the use of DP-TiSER in the TiSER oscilloscope, an eye-diagram of 12.5Gb/s  $2^{31} - 1$  PRBS data was captured as shown in Fig. 3.4. Due to the significant increase in the time-aperture, a particular number of sample points is recorded in a shorter time period than with the conventional TiSER oscilloscope. Thereby, the sampling throughput of the TiSER oscilloscope is improved by a factor of two, providing 200 times higher sampling throughput than the state-of-the-art sampling (equivalent-time) oscilloscopes [66].

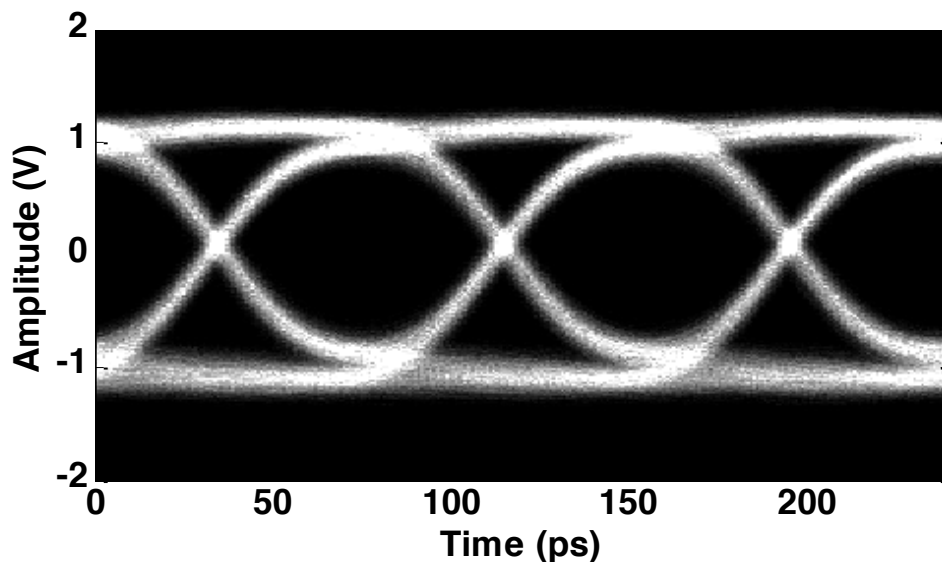

Figure 3.4: Eye-diagram of 12.5Gb/s  $2^{31} - 1$  PRBS data captured by the DP-TiSER combined with the TiSER oscilloscope. The number of sample points is twice more than the conventional TiSER oscilloscope.

### 3.4 Conclusion

In summary, I have demonstrated the dual-polarization photonic time-stretcher (DP-TiSER), which improves the spectral efficiency of TiSER. By using polarization multiplexing, this technique reduces the demand on optical bandwidth for larger time aperture per channel. I've shown that this system is able to record high-bandwidth RF signals. Furthermore, the DP-TiSER preprocessor can be used to achieve a significant improvement in the record



length and sampling throughput of the time-stretch enhanced recording (TiSER) oscilloscope.

## CHAPTER 4

### All-Optical Time-stretch Transformation

In this chapter, I demonstrate an all-optical photonic time-stretcher (TiSER) system, which captures optical signals directly, eliminating the bandwidth limitation imposed by optical-to-electrical (O/E) and electrical-to-optical (E/O) conversions [46]. This approach maps the signal under test onto a chirped optical carrier using four-wave mixing (FWM) in a highly nonlinear fiber.

#### 4.1 Introduction

Over the last decades, FWM has formed the basis for a class of versatile parametric devices enabling amplification and regeneration [67, 68, 69, 70], frequency conversion [69, 71], phase conjugation [72, 73], and optical sampling [74]. The all-optical time-stretch digitizer uses ultrafast FWM between a pre-chirped, broadband pump pulse and a wide-band optical signal. The resulting idler is a chirped broadband pulse on top of which is modulated the amplitude and phase of the wide-band optical signal. The modulated chirped idler is then stretched in time before detection, so that the signal can be recorded using a low-bandwidth photo-detector and electronic analog-to-digital converter. Another technique that achieves real-time full-field measurement of ultrafast optical waveforms was demonstrated by Fontaine et al. [75]. This method is able to measure the amplitude and phase of an optical signal by performing parallel coherent detection on spectral slices.

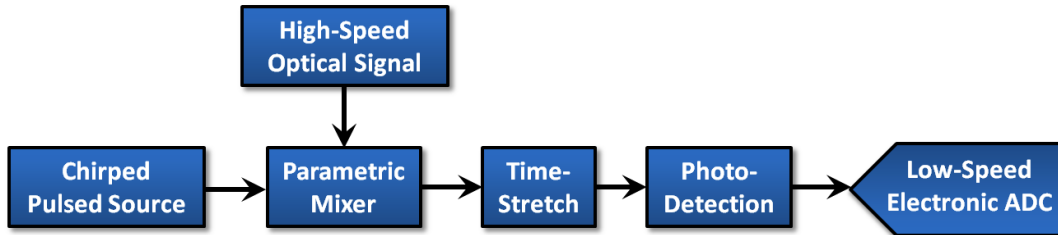

Figure 4.1: Conceptual diagram for our all-optical time-stretch technique, replacing an electro-optic modulator with a four-wave mixing process in the photonic time-stretch.

Our proposed technique, based on photonic time-stretch, should not be confused with the time-lens technique [76, 77, 78]. The two techniques are different in nature and in origin, and their differences have been previously documented [36, 79]. The time-lens is an elegant technique that constructs the temporal equivalent of a classical lens. Hence, an equivalent lens equation needs to be satisfied. It is suited for slowing down optical pulses. Photonic time-stretch is a dispersive (analog) communication link [79]. In contrast to the time lens, it does not require the input signal to be dispersed. It was originally developed for boosting the speed of electronic ADCs by slowing down the electrical waveforms before the electronic quantizer [35, 34, 36]. Due to the lack of wide-band and low loss electrical dispersive elements, the time lens is not suited for this application. In addition, in its original version for capturing electrical signals, photonic time-stretch has been extended to continuous-time operation [80, 36], a feat that is required when comparing against all-electronic ADCs. The present demonstration attempts to create an all-optical equivalent of the time-stretch technique, where it can be noted that the input signal is not dispersed.

## 4.2 Principle of Operation

To replace the electro-optic modulation to all-optical modulation in the input stage of TiSER, we employ a broadband optical pulse source as the pump for FWM. The ultrafast optical data (signal to be digitized) then represents the signal in the FWM process. The pump is pre-chirped to map wavelengths into time (i.e., wavelength-to-time mapping). This

can be realized by using a mode-locked laser (MLL) followed by a dispersive medium such as dispersion compensating fiber (DCF). The all-optical TiSER technique also employs a medium with a large nonlinear index such as highly nonlinear fiber (HNLF) to perform mixing. The HNLF is a particularly well-suited medium for this purpose, since it offers low-loss propagation and precise dispersion tailoring. From the spectral-domain point-of-view, the signal mixes with the pre-chirped broadband pump, generating a broadband chirped idler that contains information of the signal (Fig. 4.2a).

From the time-domain point-of-view, at each time instant, a wavelength of the pre-chirped broadband pump mixes with the signal, creating a modulated idler that is chirped (Fig. 4.2b). The dispersion profile of the nonlinear medium is engineered such that the zero-dispersion wavelength (ZDW) lies near the pump wavelengths, and the slope is close to zero within the signal and pump bands. This ensures maximal phase matching, and nearly no walk-off, while mixing occurs. In other words, one-to-one mapping of the signal waveform onto wavelength of the pre-chirped pump is achieved. The modulated chirped idler is then extracted and time-stretched using another dispersive medium, e.g., dispersion compensating fiber (DCF). A photo-detector converts this time-stretched optical signal to electrical domain and the resultant signal is hence a stretched replica of the original optical data signal with much reduced analog bandwidth. An electronic analog-to-digital converter that would normally be too slow can now be used to digitize the electrical signal.

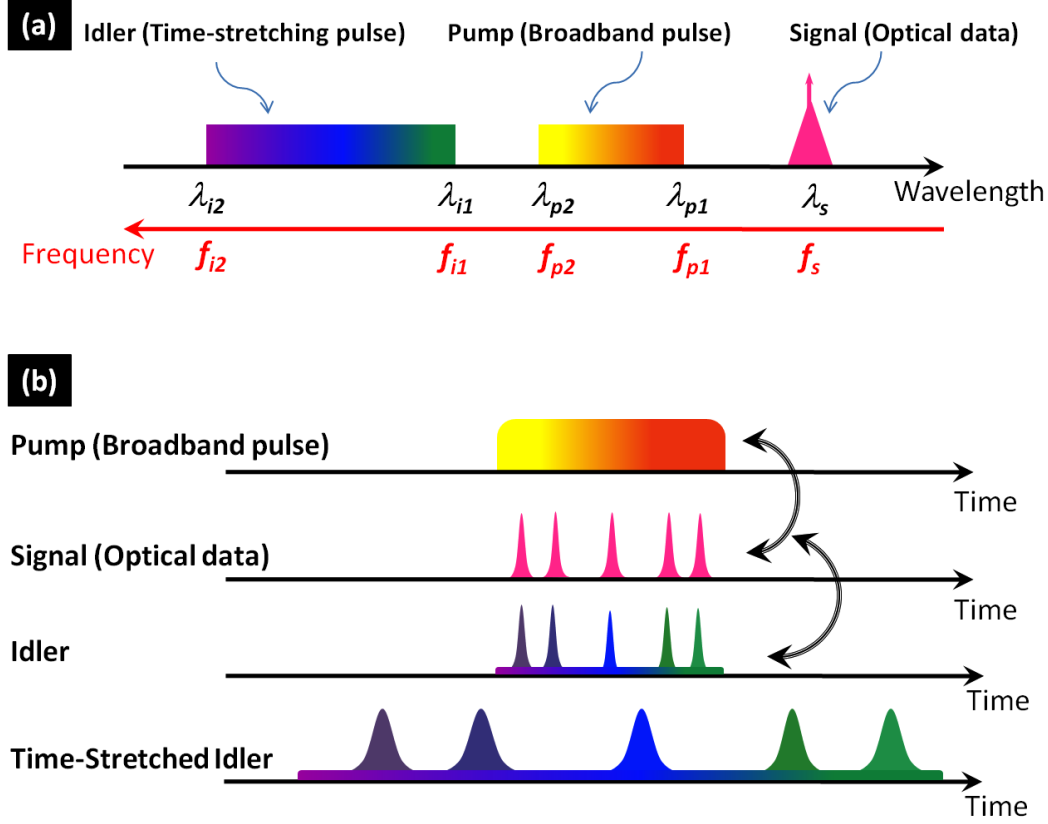

Figure 4.2: (a) Spectral-domain representation. The ultrafast optical data signal ( $f_s$ ) mixes with the broadband pulsed pump ( $\Delta f_p = f_{p1} - f_{p2}$ ) via four-wave mixing (FWM). (b) Time-domain representation. At each time instant along the signal, a wavelength of the pre-chirped broadband pump mixes with the signal at that time instant, creating a chirped modulated idler. The idler is then time-stretched to reduce the analog bandwidth of the optical data signal.

In the case of degenerate FWM process employed here, the idler frequency ( $f_i$ ) can be expressed in terms of pump ( $f_p$ ) and signal ( $f_s$ ) wavelengths,

$$f_i = 2f_p - f_s \quad (4.1)$$

Assuming that the signal's optical bandwidth is negligible compared with the pump and idler bandwidths, the idler bandwidth can be written as

$$\Delta f_i = f_{i1} - f_{i2} = 2(f_{p1} - f_{p2}) = 2\Delta f_p \quad (4.2)$$

where  $f_{i1}$ ,  $f_{i2}$ ,  $f_{p1}$ , and  $f_{p2}$  are as noted in Figure (4.2a), and  $\Delta f_p$  is the pump bandwidth. As evident from Equation (4.2), the idler bandwidth ( $\Delta f_i$ ) is at least twice larger than the pump bandwidth ( $\Delta f_p$ ). The effect has been also reported by Inoue [71] that a frequency displacement of mixing signals leads to twice the frequency shift of the mixing product. In TiSER, the time-stretch factor (S) is determined by,

$$S = 1 + \frac{D_2 \Delta \lambda_2}{D_1 \Delta \lambda_1} \quad (4.3)$$

where  $D_1$  and  $D_2$  are the dispersion values of the first and second dispersive media, while  $\Delta \lambda_1$  and  $\Delta \lambda_2$  are the optical bandwidths before and after modulation. In case of conventional TiSER [34, 36, 35], Equation (4.3) simplifies to  $S = 1 + D_2/D_1$ , since the optical bandwidths before and after modulation are constant. However, in case of all-optical TiSER,  $\Delta \lambda_1$  and  $\Delta \lambda_2$  are not the same, and are proportional to  $\Delta f_p$  and  $\Delta f_i$ , respectively. This implies that S is increased (by a factor of >2) compared with conventional TiSER. As will be discussed later in this chapter, the increase in optical bandwidth also appears to be useful in improving the bandwidth limitation due to dispersion penalty.

### 4.3 Prototype System

We constructed a prototype system illustrated in Figure (4.3). A mode-locked laser (MLL) followed by an optical bandpass filter was used to generate an optical pulse train with  $\sim 7$  nm bandwidth centered at 1565 nm and a pulse repetition rate of  $\sim 37$  MHz. The optical pulses were dispersed in time using a spool of dispersive fiber (dispersion value of -41 ps/nm) to enable wavelength-to-time mapping. The average power of the pulse train was set to 20.8 dBm using a combination of an Erbium-doped fiber amplifier (EDFA) and a variable optical attenuator (VOA). Hence, the obtained pulses had  $\sim 280$ -ps time-width, offering real-time burst sampling (RBS) over repetitive intervals that can span several sequential bits (for 40-Gb/s data). Another optical bandpass filter was used to suppress the amplified spontaneous emission (ASE) noise. The pre-chirped broadband pulse train was then fed into the FWM modulator unit as shown in Figure (4.3). The FWM modulator consists of a WDM coupler to combine the pump and signal and a  $\sim 20$ -m long segment of HNLF

with 1556-nm ZDW and  $0.0191 \text{ ps}/(\text{km}\cdot\text{nm}^2)$  dispersion slope. The output was monitored through a 1% tap on an optical spectrum analyzer (OSA).

The resulting chirped idler containing the optical data signal is picked off by a WDM and is sent to another spool of dispersive fiber (dispersion value of  $-1105 \text{ ps}/\text{nm}$ ) achieving a stretch factor of  $\sim 54$ . It is at this stage that the optical data signal is stretched in time and its analog bandwidth is significantly reduced. At the photo-detector, the stretched optical signal is converted to the electrical domain. A commercial digitizer (Tektronix DPO72004) with 20-GHz analog bandwidth and 50-GS/s sampling rate is used to digitize the time-stretched signals. Since the oscilloscope vastly over samples the signal, we used a digital low-pass filter, with 1.5 GHz cut-off frequency, to filter out higher frequency noise.

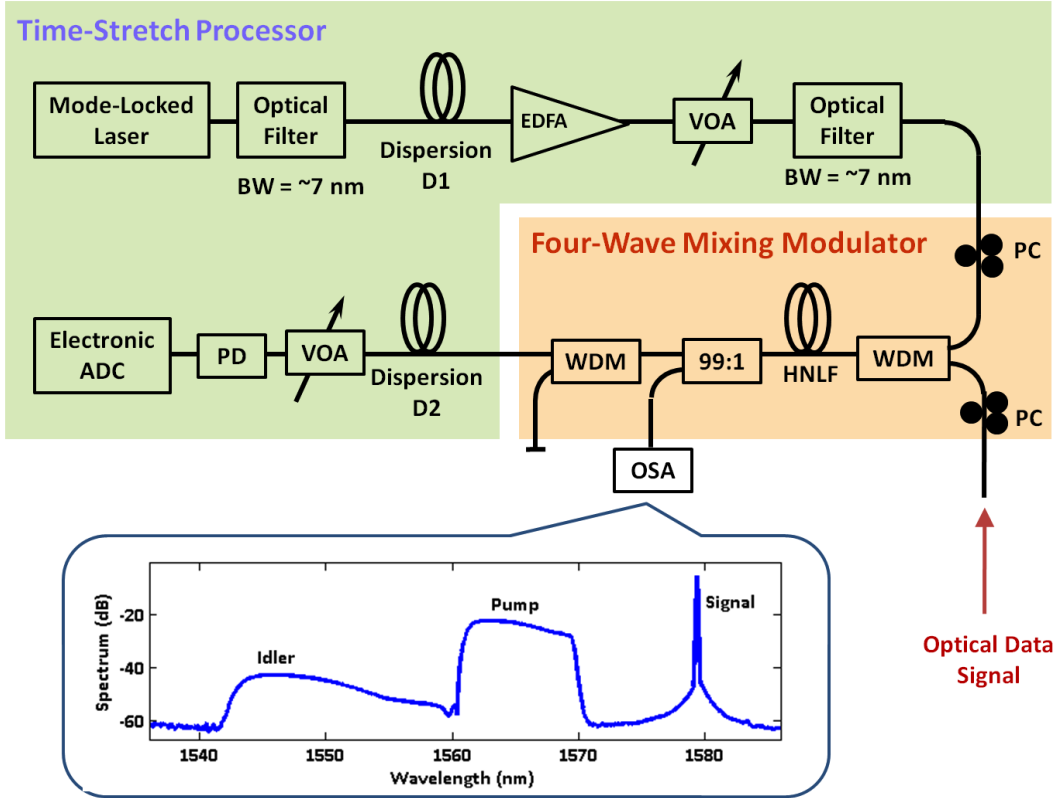

Figure 4.3: Detailed schematic of the experimental setup for demonstrating the all-optical photonic time-stretcher using four-wave mixing. BW: Bandwidth; EDFA: Erbium-doped fiber amplifier; VOA: Variable optical attenuator; PC: Polarization controller; WDM: Wavelength division multiplexer; HNLF: Highly nonlinear fiber; OSA: Optical spectrum analyzer; PD: Photo-detector; ADC: Analog-to-digital converter. Inset: spectrum of pump, signal, and idler at the output of the HNLF.

To evaluate the performance of the all-optical time-stretch digitizer, we implemented a 40-Gb/s non-return-to-zero (NRZ) on-off keying (OOK) signal transmitter as shown in Figure (4.4). This transmitter consists of a continuous-wave laser (1579nm) and >40 GHz Mach-Zehnder modulator driven by a 40-Gb/s pseudo-random bit stream (PRBS) source. An EDFA and a VOA are used to obtain the desired power level (14.2 dBm) at the output. The 40-Gb/s optical data signal is captured by the all-optical time-stretch digitizer. Real-time segments of the optical data signal spanning 8-10 sequential bits are captured every



$\sim 27$  ns (repetition rate of the mode-locked laser is  $\sim 37$  MHz) at an effective sampling rate of 1.25 TS/s as shown in Figure (4.5a). Using these segments, the original signal was reconstructed in equivalent-time mode (Fig. 4.5b).

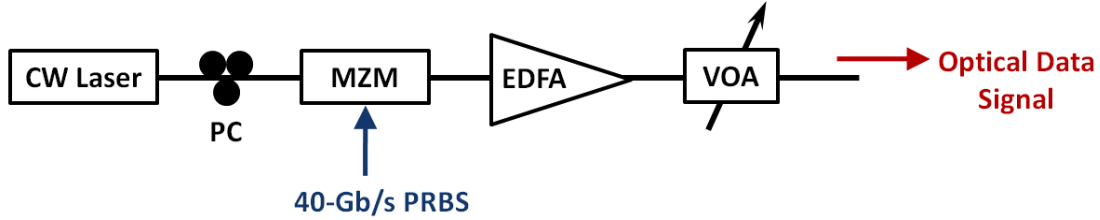

Figure 4.4: Detailed schematic of the 40-Gb/s non-return-to-zero (NRZ) on-off-keying (OOK) signal transmitter. This unit was implemented to evaluate the performance of the all-optical time-stretch pre-processor. CW: Continuous wave; PC: Polarization controller; EDFA: Erbium-doped fiber amplifier; VOA: Variable optical attenuator; PRBS: Pseudo-random bit stream source.

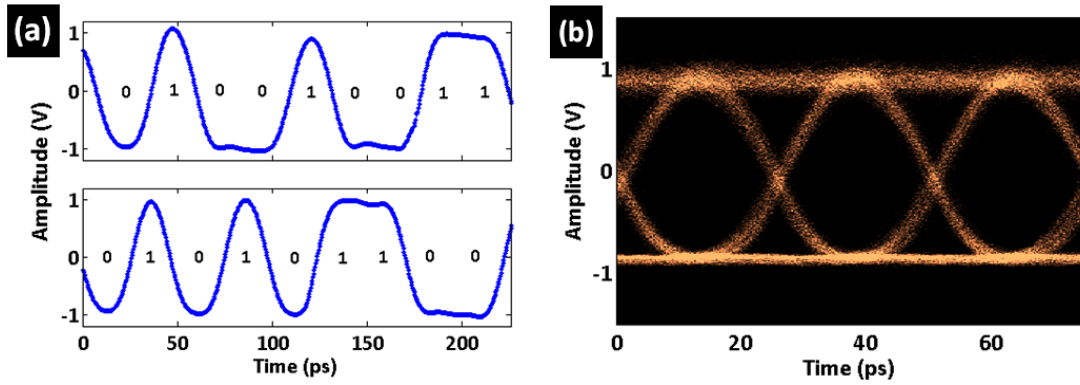

Figure 4.5: 40-Gb/s non-return-to-zero (NRZ) on-off-keying (OOK) data. (a) Two real-time segments of 40-Gb/s data captured at an effective sampling rate of 1.25 TS/s. (b) Eye-diagram of 40-Gb/s constructed from real-time segments in equivalent-time mode.

## 4.4 Dispersion Penalty and its Mitigation Using Single-Sideband Filtering

In conventional TiSER, when double-sideband modulation (DSB) is used to encode RF signals onto the optical pre-chirped carrier, a frequency-fading phenomenon due to dispersion occurs [36]. This is due to the fact that dispersion introduces different phase shifts in sidebands and leads to constructive/destructive interference beating of the sidebands with the carrier at the photodetector. This effect is illustrated in Figure (4.6a). The 3-dB RF bandwidth of TiSER that is limited:  $\Delta f_{RF} \approx [1/(8\pi |\beta_2| L_1)]^{1/2}$ , where  $\beta_2$  is the GVD parameter.

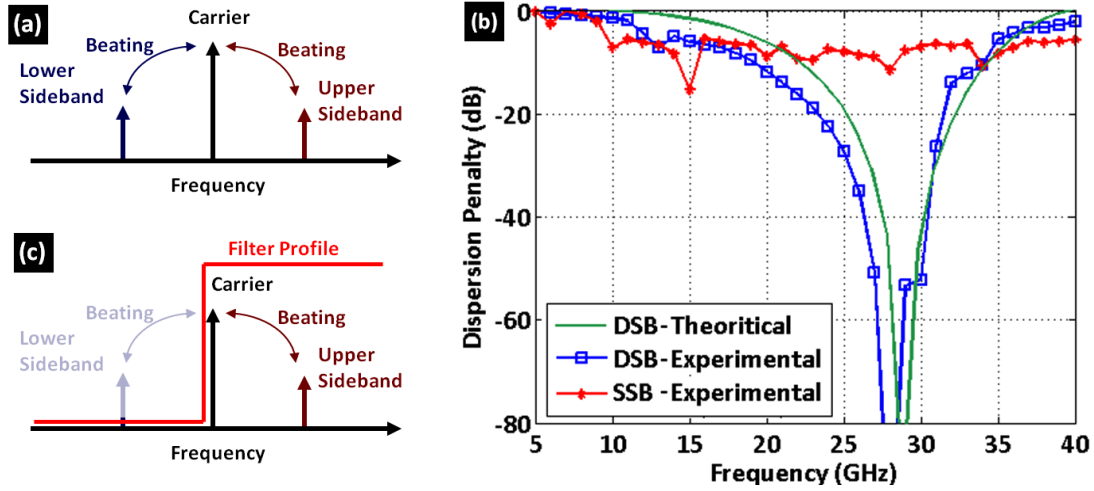

Figure 4.6: (a) If the optical data signal is double-sideband modulated, the sidebands beat with carrier and result in interference at the photo-detector. (b) Dispersion penalty in an all-optical time-stretch digitizer with an initial dispersion of -150 ps/nm. Note that we intentionally increased the initial dispersion to shift the bandwidth roll-off into the measurable range of our equipment. When double-sideband (DSB) modulation is used, the measured penalty (blue curve) that is in good agreement with theoretical prediction (green solid curve). By employing single-sideband technique, the dispersion penalty is completely mitigated (red curve). (c) Single-sideband modulation is implemented by suppressing one of the sidebands of the optical data signal. An optical bandpass filter can be used for this purpose.

Similar phenomenon is observed in all-optical TiSER. Since the optical data signal is a double-sideband modulated signal, the resultant idler is also double-sideband modulated. Therefore, the idler sidebands undergo different linear and nonlinear phase shifts, resulting in power penalty at the photo-detector. Advantageously, the increase in optical bandwidth (discussed in Section 4.2) through FWM increases the stretch factor by a factor of two, thereby reducing the dispersion fading phenomenon. The dispersion penalty 3-dB bandwidth is approximately increased by two, compared with conventional TiSER. To observe this effect and characterize the system, we intentionally increased the initial dispersion to shift the bandwidth roll-off into the measurable range of our equipment. In order to characterize the system, we implemented an optical signal generator similar to Figure (4.4) with an RF synthesizer instead of a 40-Gb/s PRBS source. The RF synthesizer was swept from 5 GHz to 45 GHz. Figure (4.6b) shows the measured dispersion penalty (blue curve) and theoretical calculation (green solid curve) for an all-optical time-stretch pre-processor with initial dispersion of -150 ps/nm. This measurement is in good agreement with theoretical calculation shown in the same plot. Note that the theoretical calculation does not consider nonlinear phase shift as explained in Reference [81]. The slight mismatch between the theoretical prediction and measurement comes from the fact that nonlinear phase shift in the fibers shifts the null frequency of dispersion penalty curve toward lower frequencies as evident from Figure (4.6b). Also, note that the 3-dB bandwidth limitation for the demonstration in Section 4.3 was >40 GHz, which is more than sufficient for capturing a 40-Gb/s NRZ-OOK signal.

In TiSER, single-sideband modulation [43] successfully eliminates the bandwidth limitation due dispersion penalty. Our all-optical time-stretch pre-processor behaves in the same way. Hence, we adapt this technique to our proposed system by converting optical data modulation format from double-sideband modulation (DSB) to single-sideband modulation (SSB) before the four-wave mixing modulation. This can be performed by using an optical bandpass filter to suppress one of the optical sidebands as illustrated in Figure (4.6c). In order to demonstrate mitigation of dispersion penalty using SSB modulation conversion, we used a programmable optical processor (Finisar, WaveShaper 1000) to implement a desired

filter profile. An optical signal transmitter (similar to Fig. 4.4) with an RF synthesizer sweeping from 5 GHz to 45 GHz was also used. Figure (4.6b) shows the measured dispersion penalty curve (red curve) for all-optical TiSER with initial dispersion of -150 ps/nm with SSB filtering. The result shows the complete mitigation of the dispersion penalty null frequency by converting the optical data signal to SSB format.

## 4.5 Conclusion

To summarize, I have proposed and demonstrated in this chapter an all-optical time-stretch digitizer for direct capture of ultrafast optical data signals. This was achieved by integrating all optical modulation into the time stretch digitizer. As a proof-of-concept prototype, I captured 40-Gb/s non-return-to-zero (NRZ) on-off keying (OOK) data. I also presented the effects of the power penalty due to dispersion and provided a solution using all-optical single-sideband modulation to mitigate this limitation.

## CHAPTER 5

### Coherent Time-Stretch Transformation

Time stretch transformation of wideband waveforms boosts the performance of analog-to-digital converters and digital signal processors by slowing down analog electrical signals before digitization. The transform is based on dispersive Fourier transformation implemented in the optical domain. A coherent receiver would be ideal for capturing the time-stretched optical signal. Coherent receivers offer improved sensitivity, allow for digital cancellation of dispersion-induced impairments and optical nonlinearities, and enable decoding of phase-modulated optical data formats. Because time-stretch uses a chirped broadband ( $>1$  THz) optical carrier, a new coherent detection technique is required. In this chapter, I introduce and demonstrate coherent time stretch transformation; a technique that combines dispersive Fourier transform with optically broadband coherent detection [82].

#### 5.1 Introduction

Photonic time-stretch analog-to-digital conversion (TSADC) extends the bandwidth and resolution of ADCs beyond the state-of-the-art by slowing down analog electrical signals before digitization[35, 34, 36, 37]. At the back-end, the slowed down signals can be captured by ADCs running significantly slower than the original Nyquist rate, and at a higher bit depth and resolution. Stretching further reduces the effective aperture jitter, and avoids channel mismatches inherent in sample interleaving architectures[33]. Previous implementations of TSADC have demonstrated record setting signal-to-noise ratio (SNR) of 45 dB and spurious free dynamic range (SFDR) of 52 dB over 10 GHz analog noise bandwidth[38]. The TSADC uses a linearly chirped broadband optical pulse train as a carrier, upon which

is modulated an analog radio-frequency (RF) signal of interest. Large chromatic dispersion further chirps the optical pulses, separating the spectral components and simultaneously stretching the modulated RF signal in time. The ratio of the optical pulse widths after and before the final dispersion determines the total stretch factor. Stretch factors of up to 250 have previously been demonstrated[39].

In optical communication links, two detection schemes can be employed: direct detection and coherent detection [83]. In direct detection, a photodetector (PD) captures an optical signal and the energy, proportional to the amplitude squared of the electric field, is converted to a current. Direct detection is the most straightforward receiver system and has been exclusively employed in TSADC thus far. Along with simplicity, however, come drawbacks. All phase information of the signal is lost, the non-linear squaring of the electric field leads to high-harmonic distortion, and the output signal lies at baseband where it is susceptible to interference from low frequency noise. In coherent detection receivers, the optical signal is mixed with a reference beam, termed the local oscillator (LO), before detection. The LO is designed to be stable and at a higher power than the signal. Upon squaring at the PD, a cross term is generated which is proportional to the linear electric field of the signal and LO. Although more complicated to implement, coherent detection offers many advantages over direct detection. High-harmonic distortion due to squaring is avoided, amplitude and phase information can be extracted, the cross term can be up-shifted away from low frequency noise, and the signal is effectively amplified by the strength of the LO. All of these benefits result in a receiver with up to 20 dB greater sensitivity [84]. Finally, with coherent detection, advanced phase and amplitude modulation schemes with high spectral efficiency and robustness to distortions can be employed [85]. For all of these reasons, coherent detection has become the universal standard in modern lightwave communications.

When considering coherent detection for TSADC, a unique challenge arises because of the chirped broadband optical carrier. Here we introduce the coherent dispersive Fourier transform (cDFT), an extension of the optical dispersive Fourier transform (ODFT) [60, 86], which for the first time enables coherent detection in the TSADC. In cDFT, we interfere

two chirped broadband optical pulses, one carrying the time-stretched RF signal and the other acting as an LO. A beat frequency is generated from the interference, from which we can recover the full optical phase and amplitude of the modulated signal. The full coherent TSADC (cTSADC) system promises to significantly improve bandwidth and resolution, as well as reduce power consumption. Additionally, when used in all-optical TSADC [46], this technique will enable time-stretching of advanced phase and amplitude modulated optical signals. As a proof-of-principle illustration, we have built a fully functioning prototype system, with an RF bandwidth of greater than 30 GHz (limited by the intensity modulator), and with a stretch factor of 24. Utilizing the information of the full complex electric field, we also achieve digital dispersion compensation across the full bandwidth of the system, and employ it in equalization of a time-stretched 40 Gbps data signal.

## 5.2 Coherent Detection

In conventional coherent detection systems, a stable continuous wave (CW) LO reference beam mixes with the signal of interest. We can represent the signal and LO electric fields in the time domain as  $E_{sig}(t) \exp(i\omega_{sig}t)$  and  $E_{LO} \exp(i\omega_{LO}t)$  respectively, where  $E_{sig}(t)$  is the time domain signal carrying information,  $E_{LO}$  is the approximately time independent electric field amplitude of the LO source, and  $\omega_{sig}$  and  $\omega_{LO}$  are the optical carrier frequencies. The optical intensity, converted to a current signal at the PD, is proportional to the amplitude squared of the sum of the electric fields

$$I(t) \propto |E_{sig}(t)|^2 + |E_{LO}|^2 \pm \text{Re}\{E_{sig}(t)E_{LO}^* \exp(i\omega_{IF}t)\} \quad (5.1)$$

where  $\omega_{IF} = \omega_{sig} - \omega_{LO}$  is the intermediate frequency (IF), and the asterisk signifies complex conjugation, with all electric fields assumed to be complex in general. The last term on the right is the cross term of interest, which scales linearly with the signal and LO electric fields, and which is upshifted to the IF. In homodyne detection, the signal and LO operate at the same frequency so the IF cancels to zero, leaving only phase offsets. In heterodyne detection the signal and LO operate at different optical frequencies, and the IF is some finite RF frequency given by the difference of the two. The plus and minus signs in front

of the cross term represent the complementary outputs of a  $2 \times 2$  interferometric mixer. Balanced detection is achieved by subtracting the two complementary outputs, leaving only the cross term.

Coherent detection offers many advantages over direct detection. With a sufficiently well characterized LO beam, the phase and amplitude of the signal electric field  $E_{sig}(t)$  can be determined in DSP. This capability has spurred the recent advances in coherent light-wave technology, in which phase and amplitude modulated signal formats are employed for improved spectral efficiency and robustness to impairments [85]. With the full complex field information, digital back propagation can be used to mitigate distortions from chromatic dispersion, non-linear amplitude modulation, and optical nonlinearities [87, 88, 89]. In heterodyne detection systems, the cross term is upshifted away from low frequency noise, allowing for improved resolution. Finally, with a high power LO, the signal is effectively amplified upon interference resulting in a mixing gain, which boosts the signal above the thermal noise limit without the need for additional amplifiers.

### 5.3 Coherent Dispersive Fourier Transform

Developing a coherent detection system for TSADC poses a unique challenge. Unlike in conventional optical communication links, which use a narrow band CW beam as the carrier, the TSADC system uses a broadband, chirped optical pulse to carry the information. If we mix a broadband, chirped pulse with a narrowband LO, the IF of the mixing term will be chirped and span the full optical bandwidth of the pulse ( $> 1$  THz). The resulting bandwidth of the heterodyne signal will extend beyond the detection bandwidth of the backend PD and electronics.

To overcome this obstacle, we have developed the cDFT. We use as the LO a second broadband chirped optical pulse, which is an unmodulated copy of the carrier pulse. When the two chirped optical pulses, relatively delayed with respect to each other, are mixed, the optical signals interfering at each point in time are offset by a constant frequency, resulting in a chirp-free IF modulation along the optical pulse (see . 5.1). The phase and amplitude



of the modulated time-stretched RF signal are encoded in the IF modulation, similar to in heterodyne detection, and can be recovered by adapting standard analog and digital techniques from coherent lightwave communications.

After dispersion, the electric field of each pulse is given by

$$\begin{aligned} E(t) &= \frac{1}{2\pi} \int \tilde{E}_0(\omega) \exp \left[ i \left( \frac{1}{2} \beta_2 L \omega^2 - \omega t \right) \right] d\omega \\ &= \frac{1}{2\pi} \exp \left( -i \frac{t^2}{2\beta_2 L} \right) \int \tilde{E}_0(\omega) \exp \left[ i \frac{1}{2} \beta_2 L \left( \omega - \frac{t}{\beta_2 L} \right)^2 \right] d\omega. \end{aligned} \quad (5.2)$$

For large dispersion, that is  $\lim_{\beta_2 L \rightarrow \infty}$ , we can exercise the stationary phase approximation (Eq (2.22)), and the electric field in Eq.(5.2) is given by

$$\lim_{\beta_2 L \rightarrow \infty} E(t) = \frac{1}{2\pi} \sqrt{\frac{2\pi i}{\beta_2 L}} \exp \left[ -i \frac{t^2}{2\beta_2 L} \right] \tilde{E}_0 \left( \frac{t}{\beta_2 L} \right). \quad (5.3)$$

Typically it is only the amplitude of the electric field which has relevance, and the time-dependent phase is ignored, with the ODFT typically described as  $|E(t)| \propto \left| \tilde{E}_0 \left( \frac{t}{\beta_2 L} \right) \right|$  after large dispersion.

When two chirped optical pulses, which are relatively delayed with respect to each other, interfere at a photodetector, the resulting signal is given by

$$\begin{aligned} I_{PD} &\propto \left| E_{sig}(t) \exp \left[ -i \frac{t^2}{2\beta_2 L} \right] \pm E_{LO}(t + \tau) \exp \left[ -i \frac{(t + \tau)^2}{2\beta_2 L} \right] \right|^2 \\ &\propto |E_{sig}(t)|^2 + |E_{LO}(t + \tau)|^2 \\ &\quad \pm \text{Re} \left\{ E_{sig}(t) E_{LO}^*(t + \tau) \exp \left[ i \left( \frac{\tau}{\beta_2 L} t + \frac{\tau^2}{2\beta_2 L} \right) \right] \right\}. \end{aligned} \quad (5.4)$$

Assigning  $\omega_{IF} \equiv \tau/\beta_2 L$  we see that the cross term is given by

$$\text{Re} \left\{ E_{sig}(t) E_{LO}^*(t + \tau) \exp \left[ i \left( \omega_{IF} t + \frac{\tau^2}{2\beta_2 L} \right) \right] \right\}. \quad (5.5)$$

The cross term is upshifted by a constant intermediate frequency  $\omega_{IF}$ , analogous to heterodyne detection.

Noting that  $\tau$  is very small in comparison to  $\sqrt{\beta_2 L}$ , and relative to the total pulse width after dispersion ( $\sim 10$  ns), the time delay  $\tau$  ( $< 50$  ps) is negligible. Additionally, the

resolution of the ODFT[61] is insufficient to resolve spectral components on that scale. With this in mind, we can ignore  $\tau$  in Eq. (5.5) and the cross term is proportional to

$$Re \{ E_{sig}(t) E_{LO}^*(t) \exp [i\omega_{IF}t] \}. \quad (5.6)$$

The cDFT technique can be made clearer by noting the similarity with Fourier transform spectral interferometry [90]. Indeed, cDFT is a single-shot spectral interferometer mapped to the time-domain via the ODFT. In conventional spectral interferometry, two optical pulses, relatively delayed, are mixed and the optical spectrum is measured. In the simplest case, one pulse is a well-characterized LO pulse, with the goal being to ascertain the spectral amplitude and phase of the electric field of the second pulse. The optical spectral intensity measured is proportional to

$$I(\omega) \propto \left| \tilde{E}_{sig}(\omega) \right|^2 + \left| \tilde{E}_{LO}(\omega) \right|^2 \pm Re \{ \tilde{E}_{sig}(\omega) \tilde{E}_{LO}^*(\omega) \exp(i\omega_{IF}\tau) \} \quad (5.7)$$

where  $\tau$  is the relative time delay and  $\omega$  the optical frequency. The similarities between Eq.(5.1) and Eq(5.7) can be seen, the crucial difference being that Eq.(5.1) is a time-domain signal and Eq.(5.7) is a frequency domain signal. The cross term of Eq. (5.7) is proportional to the signal and LO electric fields, and upshifted by an IF. If the LO spectrum is known, the phase and amplitude of the signal electric field can be determined.

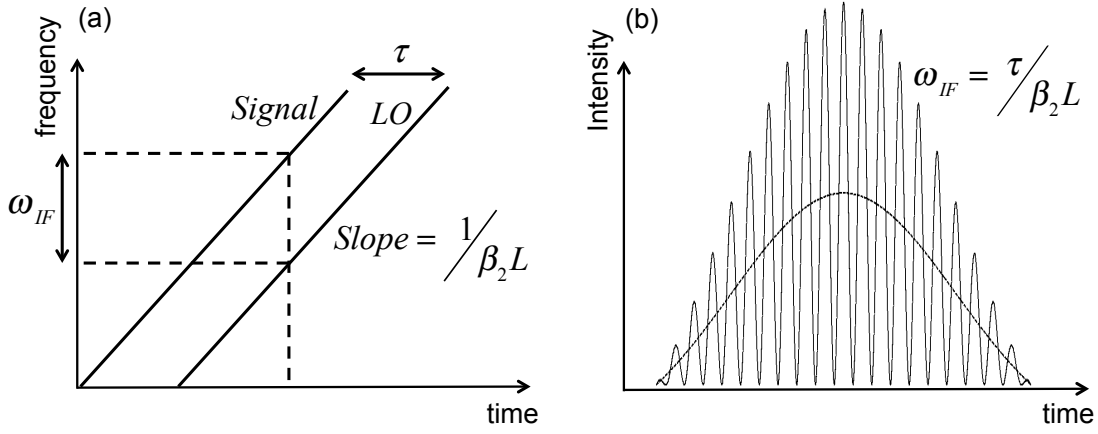

Figure 5.1: Mixing of relatively delayed chirped optical pulses results in a beat frequency in the time-domain. In (a) we illustrate the linear chirp of each pulse by a straight line on a frequency vs. time plot. The signal and LO pulses are delayed with respect to each other, resulting in interference of spectral components offset by a constant intermediate frequency,  $\omega_{IF}$ . (b) The interference results in a sinusoidal modulation along the optical pulse. If the signal pulse is modulated with an RF signal, the amplitude and phase information is encoded in the IF modulation, analogous to a coherent heterodyne signal.

In cDFT, the mixed signal is not detected by an optical spectrum analyzer, but is instead dispersed and captured with a single pixel PD. The large dispersion performs a ODFT, mapping the optical spectrum into the time domain via  $\omega \rightarrow t/\beta_2 L$ , where  $\beta_2$  is the dispersion parameter and  $L$  is the length of the fiber [61]. The complex exponential multiplying the cross term of Eq. (5.7) is transformed to

$$\exp(i\omega\tau) \rightarrow \exp\left[i\left(\frac{t}{\beta_2 L}\right)\tau\right] \equiv \exp(i\omega_{IF}t) \quad (5.8)$$

with  $\omega_{IF} = \tau/\beta_2 L$ , the IF frequency of the now time domain signal. The optical spectra of the signal and LO pulses are also transformed into time-domain traces. Advantageously, the IF can be adjusted, even for a fixed dispersion, simply by controlling the relative time-delay  $\tau$ . An example of a time-stretch pulse exhibiting an IF of 4 GHz, corresponding to a  $\tau$  of 35 ps, is shown in Fig. 5.2a, and the IFs for various time delays are plotted in Fig. 5.2b. A linear fit is well matched to the data, with a slope indicating a dispersion of 1090

ps/nm, in good agreement with the dispersion used.

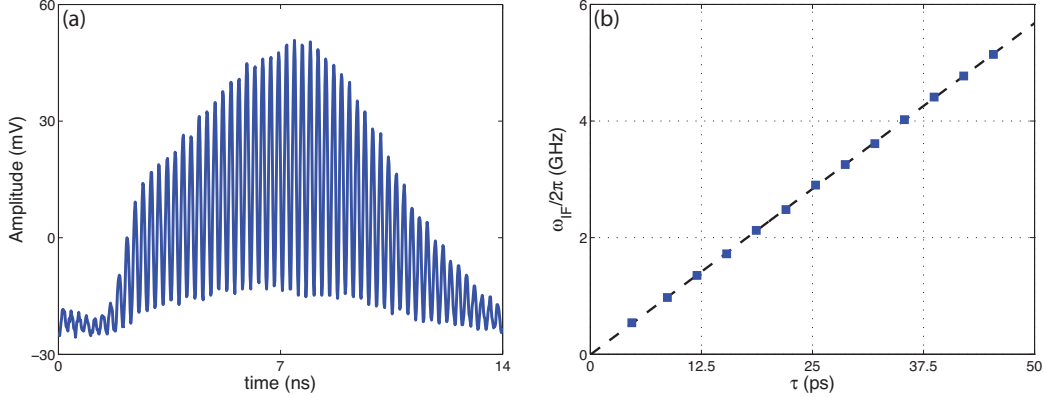

Figure 5.2: Interference of two broadband, chirped optical pulses results in an intermediate beat frequency along the pulse. (a) In this example, a time delay of 36 ps between the two pulses results in an intermediate frequency of 4 GHz. (b) We characterized the intermediate frequency for a range of relative delays. The measured dispersion of 1090 ps/nm, calculated from the slope, is in agreement with the dispersive fibers used.

In the cTSADC system, the LO pulse is an unmodulated copy of the signal pulse, and it is the RF time-stretched signal that is being characterized, not the inherent phase and amplitude of the carrier pulse electric field. The signal and LO spectral profiles from Eq. (5.7), after ODFT can be written as

$$\tilde{E}_{LO}(\omega) \rightarrow E_{env}(t), \tilde{E}_{sig}(\omega) \rightarrow E_{env}(t)E_{RF}(t) \quad (5.9)$$

where  $E_{RF}(t)$  is the time-stretched RF signal, and  $E_{env}(t)$  is the optical spectrum of the original broadband pulse mapped to the time-domain. Here again, as in Eq. (5.6) we are ignoring  $\tau$ . After balanced detection, the signal is proportional to the cross term of Eq. (5.7), with the substitutions of Eq.(5.8) and Eq.(5.9),

$$I_{BD} \propto |E_{env}(t)|^2 Re \{E_{RF}(t) \exp(i\omega_{IF}t)\} \quad (5.10)$$

The task, finally, is to characterize the envelope trace and to employ coherent lightwave

communication processing techniques to recover the full phase and amplitude information of the linear time-stretched RF signal.

## 5.4 Experimental Setup

We implemented an optical fiber based cTSADC prototype system(Fig. 5.3). An Erbium doped fiber mode locked laser (MLL) generates a 37MHz optical pulse train, which is band-pass filtered around 1570 nm to 10 nm 3 dB bandwidth. We pre-chirp the pulse train using a dispersive fiber of 45 ps/nm dispersive parameter, stretching the pulses to 450 ps width. An erbium doped fiber amplifier (EDFA) amplifies the pre-chirped pulse train to 20 dBm average power before a  $1 \times 2$  splitter separates the pulses into signal and LO. The signal pulses are sent to a Mach-Zehnder modulator (MZM), which modulates the RF signal on top. The LO is sent through a variable optical attenuator (VOA), which matches the insertion loss of the MZM ( $\sim 7$  dB). It is important to match the powers of the signal and LO pulses at the receiver to maximize modulation depth of the interference fringes and to ensure the IF amplitude spans the full scale of the back end ADC. The two pulse trains are counter-propagated through a second dispersive fiber of 1045 ps/nm dispersion imparting a total stretch factor of 24. Optical circulators (OC) at each end of the dispersive fiber direct the pulses into and out of the dispersive fiber accordingly. A delay line in one of the arms adds the relative time delay  $\tau$ . In this demonstration we used a delay of 47 ps for an IF of 5.3 GHz. The signal and LO pulses are mixed in a  $2 \times 2$  coupler, the two outputs being complementary. The polarizations of the two optical beams are aligned using a fiber coupled polarization controller in one of the arms (not shown in Fig. 5.3). In lieu of a balanced detector (BD), we delay the complementary output pulses, staggering them in time, before combining and sending to a single pixel PD. The complementary pulses are realigned and subtracted digitally. If subtraction of complementary outputs were carried out before digitization, matching of signal and LO optical power would not be necessary and mixing gain could be achieved. Average power reaching the PD is approximately -6 dBm. A trans-impedance amplifier integrated on the PD amplifies the photocurrent, which

is then digitized by a 50 GSps, 16 GHz ADC. All patch chords are single mode fiber of total length less than 10m and negligible dispersion (17 ps/nm-km).

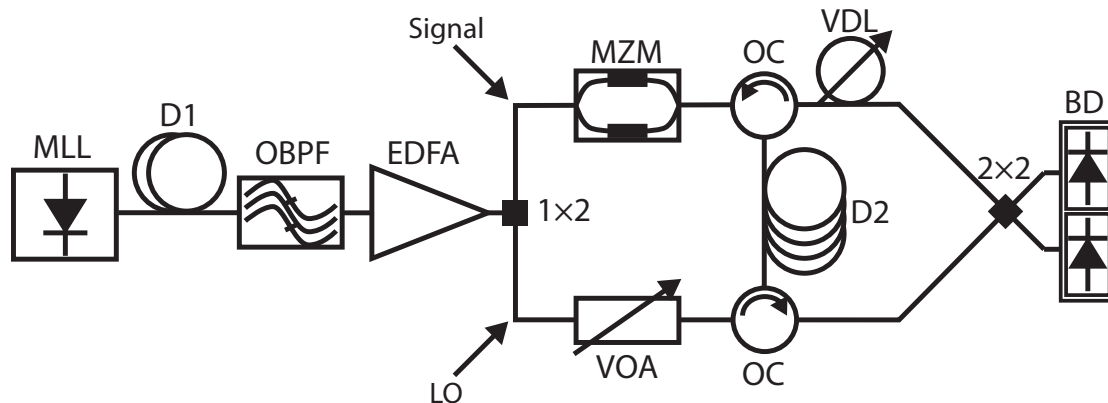

Figure 5.3: Schematic of the optical portion of the cTSADC system. After photo-detection the time-stretched analog signal is digitized and processed digitally. In this demonstration, balanced detection was performed using a single PD, with the complementary pulses delayed in time to avoid overlap. Subtraction was performed digitally. D1: first dispersive fiber, D2: second dispersive fiber, OBPF: optical band-pass filter, VDL: variable delay line

## 5.5 Digital Signal Processing

DSP is implemented in MATLAB[91] to subtract the complementary outputs, down-convert the IF signal, divide out the spectral envelope, and recover the full amplitude and phase information of the time-stretched RF signal. Balanced detection is performed digitally by capturing both complementary outputs from the  $2 \times 2$  interferometer in a single PD. The complementary outputs are aligned and subtracted, removing the common mode DC portion of the optical pulses (see Fig.5.4). The subtracted signal is band-pass filtered around the IF to remove out of band noise, in particular  $1/f$  noise at lower frequencies. We perform a discrete Hilbert transform on each pulse, extract the instantaneous frequency of the IF signal and average over 1000 pulses[92]. We then down convert the upshifted signal to baseband. Because the RF time-stretched signal is AC coupled and uncorrelated with the laser pulses, averaging of the 1000 pulses leaves only the background envelope. We

divide out the background from each pulse to recover the full complex electric field of the modulated RF signal. With the knowledge of the linear complex electric field, steps can be taken in the digital domain to remove distortions from non-linear amplitude modulation, parasitic dispersive effects, and optical non-linearities.

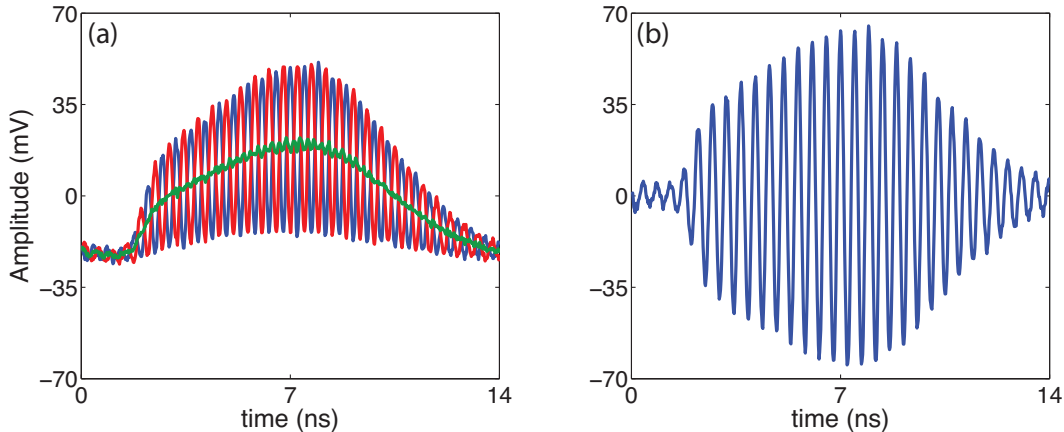

Figure 5.4: We capture both outputs of the  $2 \times 2$  interferometer and perform subtraction digitally. (a) The complementary outputs (blue and red) are aligned. (b) After subtraction the common mode signal is rejected, and the complementary portions are added, resulting in higher SNR

## 5.6 Dispersion Compensation

As an illustration of the power of cTSADC, we digitally equalize the parasitic dispersion penalty. Dispersion acts by imparting a phase quadratic with optical frequency, i.e.  $\exp(i\beta_2 L\omega^2/2)$  [67]. In an optical communication link using double sideband modulation and direct detection, this dispersion induced phase leads to an intensity transfer function proportional to  $\cos(i\beta_2 L\omega_{RF}^2/2)$ , limiting the bandwidth of the system [42] Conceptually one can understand this intensity attenuation as arising from destructive interference of the two sidebands modulated about the carrier, which accrue different dispersion induced phase shifts because of their different optical frequencies.

In TSADC, dispersion is exploited to our advantage, to map the optical spectrum into time and stretch the RF modulated signal. However, the parasitic dispersive effect still

manifests itself, though with an attenuated dispersion induced phase,

$$\exp\left(i\frac{1}{2}\frac{\beta_2 L_2}{M}\omega^2\right) \quad (5.11)$$

where  $M$  is the stretch factor, and  $L_2$  the length of the second dispersive fiber [36]. Two methods exist which allow TSADC to overcome this bandwidth limiting dispersion penalty: one employs single side-band modulation to avoid the interference at the detector [36, 43] and the second, termed phase diversity, uses maximum ratio combining of two outputs from a MZM, which have inherently complementary transfer functions [44]. However, there is as yet no general technique to mitigate the dispersion penalty for an arbitrarily modulated input. Additionally, with all-optical TSADC, for which the dispersion penalty is the only bandwidth limitation, the above techniques are not always applicable and a more general technique is required.



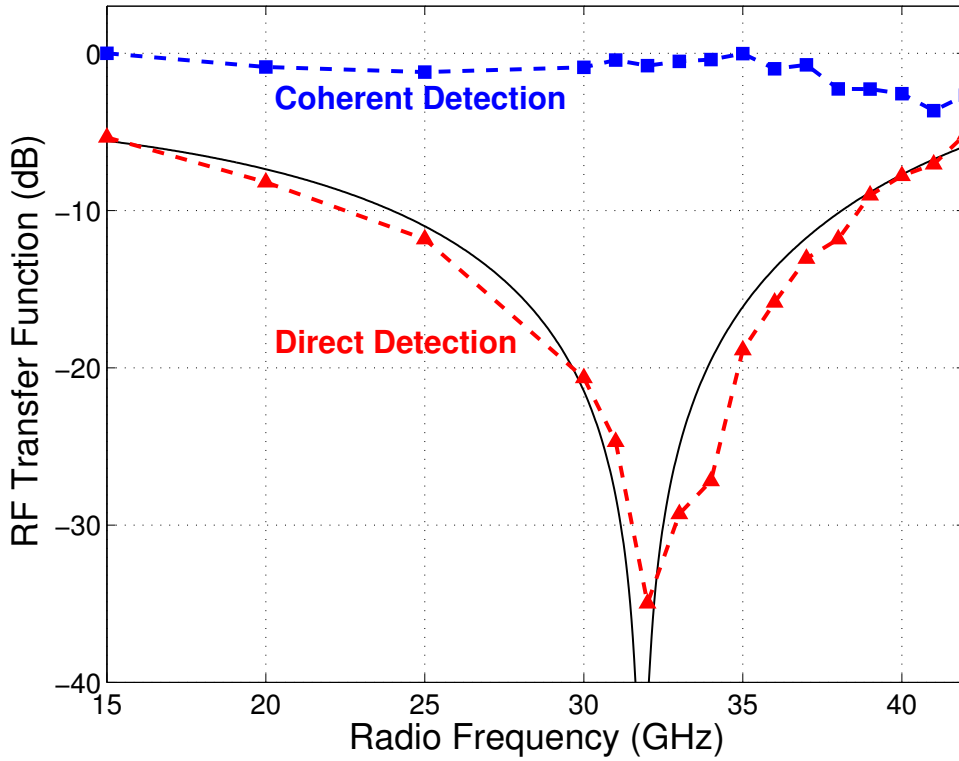

Figure 5.5: With direct detection, parasitic dispersion results in transfer function nulls, limiting the bandwidth. In coherent detection we can recover the full complex field, allowing for equalization of the dispersion penalty and a flat transfer function. The roll off at higher frequencies is due to limitations of the intensity modulator. Plotted along with the raw data is a sinusoidal model function fit to the un-equalized direct detection transfer function. The dispersion-induced phase was calculated from Eq. 5.11 and the additional chirp parameter was estimated from non-linear regression.

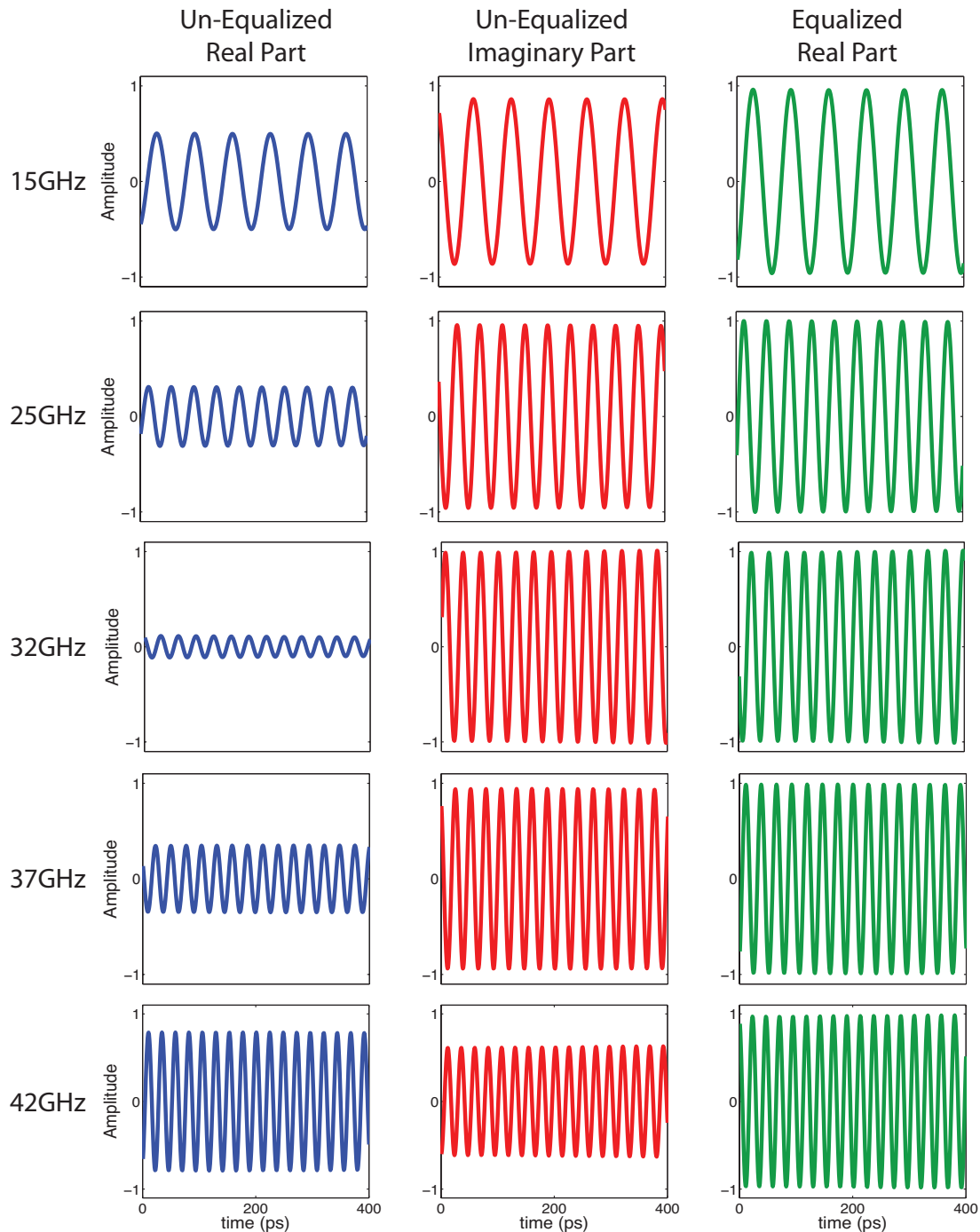

Figure 5.6: Conceptually, the dispersion induced phase acts to rotate the electric field in the complex plane. Each frequency component experiences a different rotation, dependent on the square of the frequency. The total power of the RF signal remains constant, but the balance of power between real-part (blue) and imaginary-part (red) shifts depending on the frequency. Equalization inverts the frequency dependent phase shift, returning all power back to the real-axis (green). Without coherent detection, the full complex field information is lost, and to linear approximation the recovered RF signal matches the attenuated power of the real-part.

With the full complex optical field captured using cTSADC, we are able to digitally equalize the dispersion induced phase in Eq. (5.11). For each captured pulse we take a 576 point discrete Fourier transform and multiply by the inverse of the exponential in Eq. (5.11). A set of 576 samples (sample rate is 50 GSps) spans 11.5 ns, the approximate pulse width after stretching. We characterized the transfer functions for both conventional direct detection and broadband coherent detection back-ends by capturing and time-stretching single-tone RF signals ranging from 15 GHz to 43 GHz. We performed dispersion compensation on the coherent detection data, and plotted the intensities for each frequency (Fig. 5.5). From Eq.(5.11) we calculate the dispersion induced phase to be  $25.6 \text{ ps}^2$ . The z-cut MZM imparted an additional chirp-induced phase to the sinusoidal transfer function, shifting the first dispersion null to a lower frequency and further limiting the RF bandwidth. A non-linear regression estimated the chirp parameter to be 0.61, and this effect was accounted for in the dispersion compensation [93]. Dispersion compensation mitigates the parasitic dispersive effects, boosting the bandwidth of TSADC.

The dispersion induced phase shift acts to rotate the RF signal in the complex plane. Because the dispersion induced phase is frequency dependent, each frequency component of the signal rotates a different amount. Coherent detection recovers the full complex field profile of the RF signal and dispersion compensation inverts the rotation of each frequency component back to the real-axis. With all frequency components aligned, we can recover the original RF signal without distortion. In Fig. 5.6 we illustrate the rotation in the complex plane of each frequency component by plotting the real and imaginary parts of a time-stretched sinusoidal signal at a range of frequencies. With increasing frequency, the amplitude of the real-part decreases as the amplitude of the imaginary part increases, until a null is reached at approximately 32 GHz ( $\phi_{DIP} = \pi/2$ ). The magnitude of the RF signal (real part squared plus imaginary part squared) remains constant. At higher frequencies, the balance of power shifts back to the real-part of the RF signal. The phase relation of the real and imaginary parts shifts  $180^\circ$  after the null at 32 GHz, indicating that  $\phi_{DIP} > \pi/2$ . To linear approximation, the PD recovers only the real-part of the RF signal, so that the amplitude of the real-part in Fig. 5.6 follows approximately the direct detection transfer

function of Fig. 5.5. In compensating dispersion, we are inverting the phase shift between the real and imaginary parts. In Fig. 5.6 we plot in green the equalized real-portion of the RF signal at each frequency component. Inverting the dispersion induced phase shifts transfers all power of the RF signal to the real-axis, aligning the frequency components and eliminating distortion.

To further demonstrate the dispersion compensation capabilities, we captured a 40 Gbps pseudo-random binary sequence (PRBS) signal and generated eye-diagrams for both direct detection and coherent detection back-ends. The signal out of the PRBS generator is 1 V peak-peak. The 40 Gbps MZM used has a  $V\pi \approx 4V$ , which required amplification to achieve a reasonable modulation depth. We used a 65 GHz RF amplifier, with 22dBm saturation power, and 9 dB attenuation to boost the PRBS signal to 2.8V. With direct detection, dispersion penalty distorts the eye-diagram due to high-frequency attenuation (Fig. 5.7a). When applying dispersion compensation with the cTSADC system the distortion is mitigated (Fig. 5.7b). As an indication of the increased bandwidth due to dispersion compensation, we recorded improvement in rise/fall times, measured at 10% and 90% levels, from 18.5/19.1 ps to 16.1/15.8 ps.

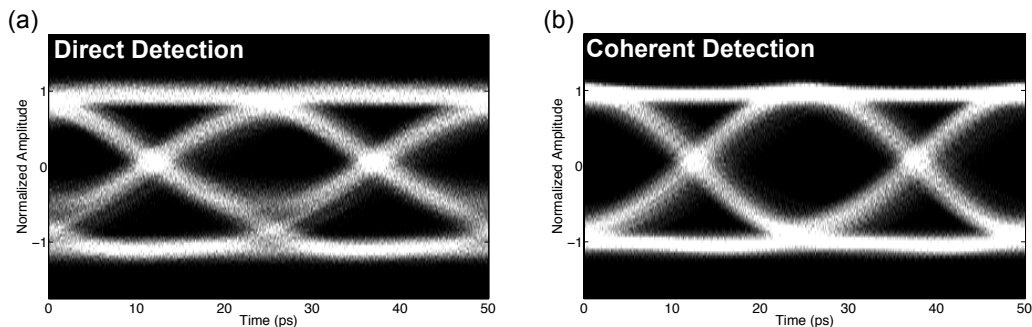

Figure 5.7: 40 Gbps PRBS data was time-stretched and detected using optical direct detection (a) and broadband coherent detection (b). A dispersion penalty transfer function, characterized in Fig. 5.5, imparts a frequency limitation when using direct detection, which can be equalized digitally using coherent detection. Rise/fall times, measured at 10% and 90% levels, improved from 18.5/19.1 ps to 16.1/15.8 ps upon equalization.

## 5.7 Conclusion

Photonic TSADC is a powerful technology that boosts the bandwidth and resolution of ADC technology, enabling many advanced applications, such as for military systems, biomedical diagnostics, and telecommunications. In this paper, we demonstrated for the first time a TSADC system with a coherent receiver back-end, which promises to offer to TSADC many of the benefits that coherent detection has brought to modern lightwave communications. In particular, we developed a fully functioning prototype cTSADC system with a stretch factor of 24 and analog bandwidth of  $> 30$  GHz, which captures the full amplitude and phase information of a time-stretched RF signal. Taking advantage of the full field information, we successfully performed digital dispersion compensation, equalizing the bandwidth reducing parasitic dispersive effect. Further studies will develop and characterize improvements in SNR from upshifting the signal away from low frequency noise, avoiding the non-linear distortion from square-law detection, and through implementing additional distortion corrections such as equalization of non-linear modulation. When combined with analog balanced detection, mixing gain can also be exploited to boost the signal power and improve sensitivity without additional optical or electrical amplifiers. Looking further ahead, application of this coherent detection technique in all-optical TSADC will improve the bandwidth, as well as allow it to capture advanced phase and amplitude optical modulation formats. With all of the afforded benefits, we foresee broadband coherent detection to become the standard receiver system for TSADC.

## CHAPTER 6

### Photonic Time-Stretch Applications

In this chapter I discuss applications of TiSER. A dual-channel TiSER prototype is used to capture 100 Gbps differential quadrature phase shift keyed optical data [47]. TiSER is used for rapid bit-error rate estimation in an optical packet switching network test bed at Columbia University. Finally, I present simulations and discuss the potential for TiSER to be used for instantaneous frequency measurements.

#### 6.1 Performance Monitoring 100 Gbps DQPSK Signal

Optical performance monitoring (OPM) [94, 95, 96] is an important function in self-managed and reconfigurable optical switch networks because it provides invaluable information about mean-time-to-repair and mean-time-to-failure. OPM functionality requires rapid measurement and evaluation of the high-data rate signal quality in a very short time scale. Moreover, the need for efficient use of bandwidth has fueled the use of advanced data modulation formats, such as differential quadrature phase-shift keying (DQPSK), multi level quadrature amplitude modulation (QAM) [10, 11, 12, 13]. In contrast to the conventional binary signaling where a 1-bit quantizer (limiting amplifier) is sufficient to digitize the data, detection and monitoring of such data formats require analog-to-digital converters (ADC) which are difficult to realize because of the ultra high real-time bandwidth that is required.

The photonic time-stretch analog-to-digital converter (TSADC) [34, 35, 36, 97] is one of the potential solutions for such applications. By extending the bandwidth of electronic converters, it is capable of digitization of continuous ultra-high bandwidth electronic signals

[39] with high resolution [38]. With the use of single sideband modulation [36] or phase diversity [36], the TSADC has no fundamental bandwidth limitation, although in practice the maximum bandwidth is limited by that of the electro-optic modulator. Called time-stretch enhanced recording (TiSER) oscilloscope [40], the single channel version of TSADC has a simple architecture and offers real-time burst sampling (RBS) over repetitive intervals that can span hundreds of sequential bits (for 100 Gbps data). In addition to the RBS capability, it provides much higher sampling throughput than sampling oscilloscopes hence reducing the time for bit error rate characterization [40].

The TiSER oscilloscope has proven its capability of capturing amplitude-modulated signal. However, capture of phase- and amplitude-modulated signals requires simultaneous detection and digitization of in-phase (I) and quadrature-phase (Q) components of the signal in order to enable reconstruction of the original signal in the digital domain. In this letter, we demonstrate the two-RF-channel version of TiSER with differential detection front-end for capturing optical DQPSK signals. We also show signal monitoring of 100-Gb/s RZ-DQPSK data degraded by different channel impairments. This system holds promising capabilities of rapid performance evaluation in high-capacity optical networks employing phase- and amplitude- modulation formats.

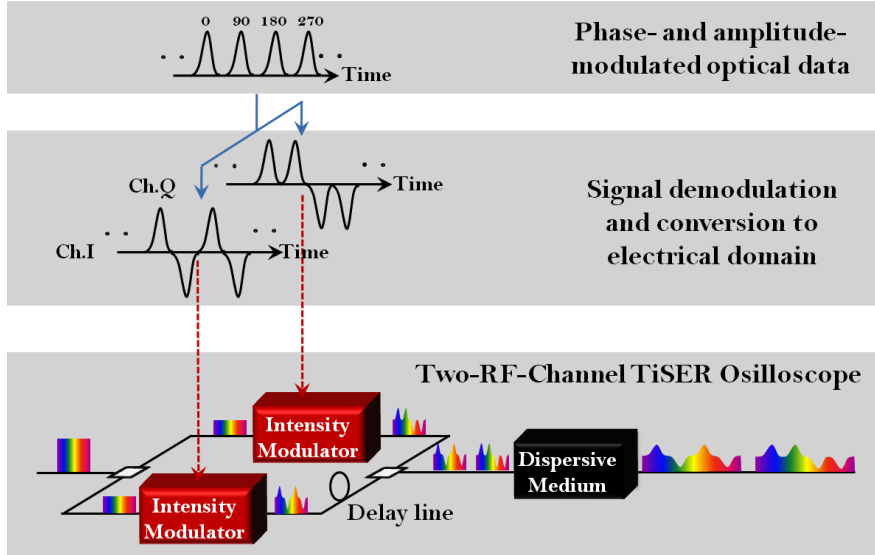

Figure 6.1: Conceptual diagram of two-RF-channel time-stretch enhanced recording (TiSER) oscilloscope with differential detection front-end for 100-Gb/s RZ-DQPSK signal monitoring. This scheme provides minimal mismatch between the captured I/Q-data.

The proposed system uses an optical differential detection front-end to demodulate the DQPSK signal into two electrical signals (i.e., denoted by Ch.I and Ch.Q) by means of a pair of one-bit delay-line interferometers and two balanced receivers. Consequently, it performs the RBS on two electrical channels simultaneously. The two-RF-channel TiSER oscilloscope uses only one wavelength-channel to capture both I- and Q- channels. As illustrated in Fig. 6.1, a train of pre-chirped broadband pulses is equally split into two paths (i.e., two channels) and guided through two high-speed intensity modulators. In order to phase-lock the I- and Q- channels, the signal paths from delay-line interferometers to the intensity modulators are tuned so that the corresponding bits of I- and Q- signals are captured at the same time. The modulated pulse trains are delayed with respect to each other and sent through the second dispersive medium for time-stretching. This configuration provides minimal mismatch between the captured I- and Q- signals.

To demonstrate the performance of the two-RF-channel TiSER oscilloscope, we implemented a 100-Gb/s RZ-DQPSK signal transmitter (Fig. 6.2). This transmitter consists of a continuous-wave laser (1552.524 nm), a  $> 40$  GHz nested Mach-Zehnder modulator



driven by two 50 Gb/s pseudo-random binary sequences, and finally a 50% RZ pulse carver to create RZ pulses. Two polarization controllers in front of the modulators are adjusted to maximize the signals output power and extinction ratio. The signal is then boosted by an Er-doped fiber amplifier (EDFA) and sent through tunable chromatic dispersion (CD) and differential-group-delay (DGD) emulators so as to add different distortions onto the signal. Finally, the 100-Gb/s RZ-DQPSK signal is amplified and filtered by means of an EDFA and a 1.2-nm bandpass filter (BPF). Different types of optical impairments such as chromatic dispersion, differential group delay, and optical loss are applied to the optical data through the impairment emulator units (Fig. 2).

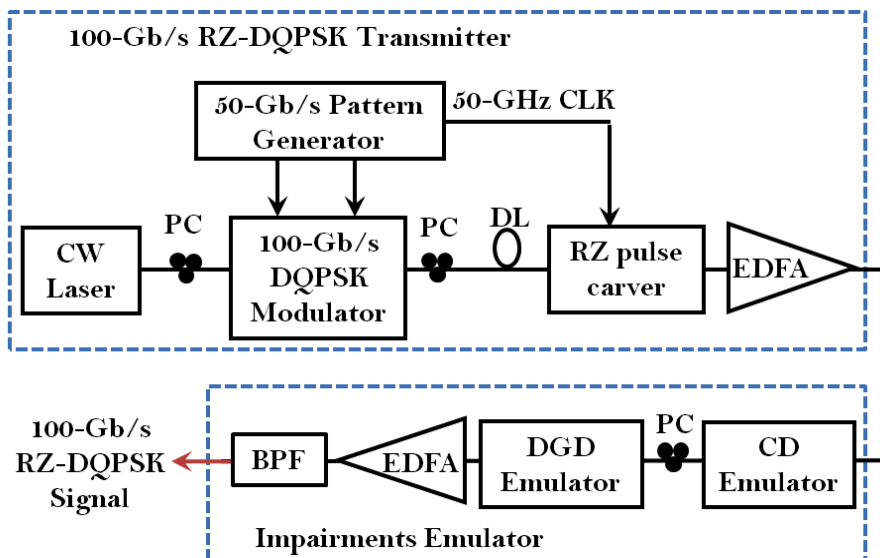

Figure 6.2: Detailed schematic of the 100-Gb/s RZ-DQPSK signal transmitter and optical impairment emulation units. CW: Continuous wave, DGD: Differential group delay, CD: Chromatic dispersion, DL: Delay line, PC: Polarization controller, EDFA: Erbium-doped fiber amplifier, CLK: Clock, BPF: Bandpass filter.

To capture the 100-Gb/s RZ-DQPSK data using the proposed system, we constructed an experimental apparatus as shown in Fig. 6.3. The optical signal to be captured is equally split into two paths and sent to two pairs of 50-GHz delay-line interferometers and 40-GHz balanced receivers (u2t Photonics XPRV2021) for generating I- and Q-data streams. Also, a mode-locked laser generates a pulse train with  $\sim 20$  nm bandwidth centered at 1571 nm

and a pulse repetition rate of  $\sim 37$  MHz. The pulses are then pre-chirped using a spool of dispersion compensating fiber (dispersion value of  $-657$  ps/nm). The pulse train is split into two paths and sent to two separate 50 GHz Mach-Zehnder intensity modulators, where the broadband pre-chirped pulses are modulated with I- and Q-data streams. Polarization controllers are used to align the polarizations to the principal axes of the modulators. The modulated pulse trains are delayed with respect to each other, amplified, and sent to the second dispersion compensating fiber (Fig. 3). The dispersion values of the dispersive fibers are chosen such that a stretch factor of  $\sim 34$  is achieved. After photodetection, the resultant RF signal is a stretch replica of the original signals with significantly reduced analog bandwidth. A commercial digitizer (Tektronix DPO71604) with 16 GHz analog bandwidth and 50 GSps sampling rate is used to digitize the time-stretched signals. Note that digital low-pass filtering with cut-off frequency of 2 GHz is also applied to emulate a monolithic commercial ADC.

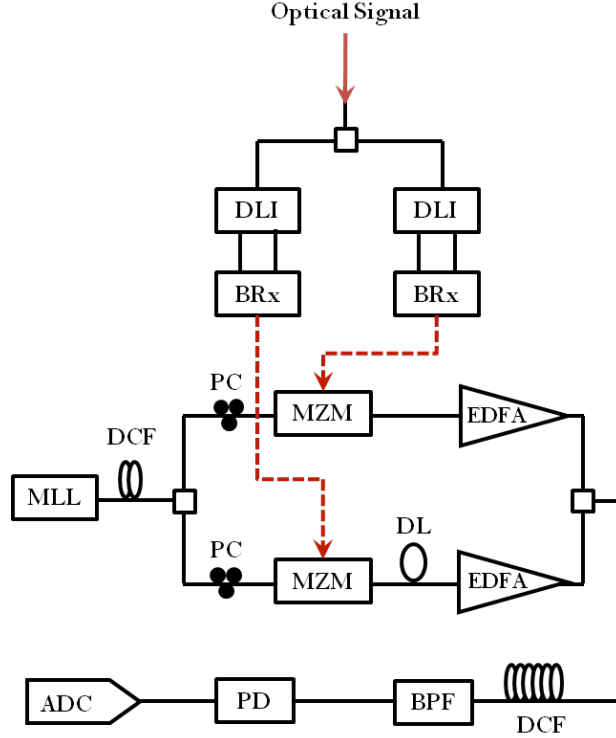

Figure 6.3: Detailed schematic of the two-RF-channel time-stretch enhanced recording (TiSER) oscilloscope with differential detection front-end. Solid (black) and dashed (red) lines represent optical fibers and electrical cables, respectively. DLI: Delay line interferometer, BRx: Balanced receiver, MZM: Mach-Zehnder modulator, EDFA: Erbium-doped fiber amplifier, MLL: Mode-locked laser, DL: Delay line, BPF: Bandpass filter, PD: Photodetector, ADC: Analog-to-digital converter, PC: Polarization controller, DCF: Dispersion compensating fiber.

The systems time aperture, i.e. the duration of real-time captured segments is found to be  $\tau_A = D1 \cdot \Delta\lambda = 400ps$ , where  $D1$  (-20 ps/nm) is the dispersion value of the first dispersive fiber and  $\Delta\lambda$  (20 nm) is optical bandwidth. As a result, all captured segments consist of 680 sample points that repeat every  $\sim 27$  ns (repetition rate of the mode-locked laser is  $\sim 37$  MHz). Using these segments, the eye-diagrams of 100 Gb/s data are generated in equivalent time as shown in Fig. 4. Also, since the timings of the pre-chirped pulses and I/Q-data are aligned, the corresponding bits of I- and Q- signals are found to generate the constellation diagrams of the original data (Fig. 6.4). More importantly, the eye and

constellation diagrams shown here are generated from a 400 sec time interval of data, which is three to four orders of magnitude shorter than conventional methods for capturing these diagrams [40]. This means that the performance of the optical channel can be monitored in a very shorter time scale. Moreover, these real-time segments of the DQPSK signal captured by the system provide useful information about the channel and hence, facilitate equalization algorithm development for the optical network.

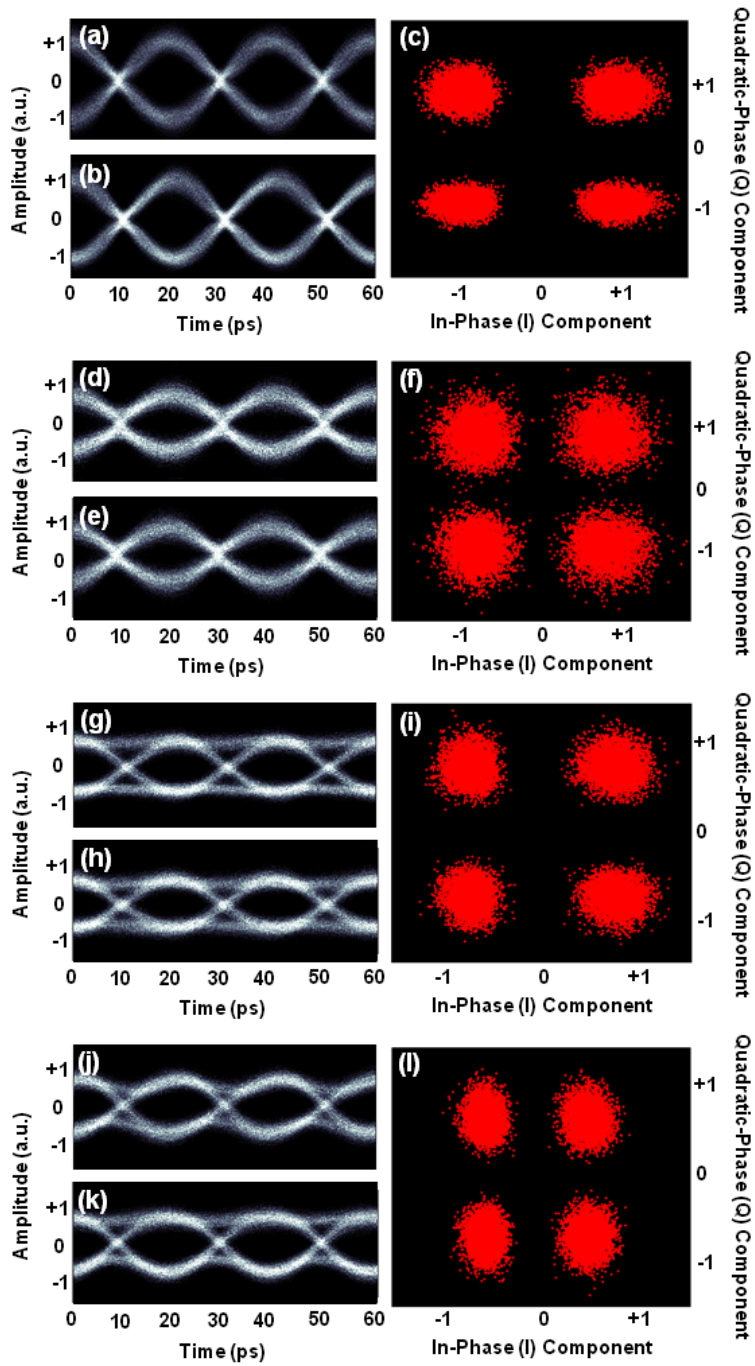

Figure 6.4: Eye and constellation diagrams for 100-Gb/s RZ-DQPSK data captured by the two-RF-channel TiSER oscilloscope. I/Q diagrams (a)-(c) without any channel impairments, (d)-(f) with 10-dB optical loss, (g)-(i) with differential group delay of 5 ps, (j)-(k) with chromatic dispersion of -20 ps/nm.

In conclusion, we have proposed and demonstrated the two-RF-channel time-stretch enhanced recording oscilloscope with differential detection front-end for 100-Gb/s RZ-DQPSK signal monitoring in high-capacity optical networks. Captured eye and constellation diagrams of 100-Gb/s RZ-DQPSK data undergone different types of channel impairments are shown. This system provides a useful tool for rapid performance monitoring of high rate advanced data modulation formats.

## 6.2 Real-time Bit-error Rate Estimation

The average rate at which bits in digital data stream are incorrectly interpreted after passing through a communication channel is termed the bit error rate (BER). A certain number of errors can be tolerated through the addition of redundancy into the data sequence and forward error correction (FEC). However, at large enough BER, the redundancy and FEC techniques are insufficient to recover the signal and the data channel can become completely corrupted. It is very important to test the BER of a channel or transmitter before deploying in the field, as well as to monitor the performance once in the field.

There are generally two methods of testing the BER. The BER can be directly measured by sending a known sequence through a channel, detecting it, and counting the number of mismatches between the transmitted and detected sequences. Although this is a true and accurate method for measuring BER, it can take quite a long to gather enough bits before an error is found, especially at low BERs. Accounting for the random Poissonian distribution of errors, to get a reasonable confidence level (CL) (say 95%) for a specific BER ( $10^{-12}$ ), would require 5 minutes of error free detection at 3 Gb/s. When dozens or more links and transmitters need to be tested, this 5 minutes minimum per test can add up and limit productivity. Additionally, the requirement of knowing the data sequence being transmitted makes this direct BER measurement technique unsuitable for the field.

Another method for estimating the BER of a channel involves generating an eye-diagram, fitting approximate Gaussian distributions to the noise broadened zero and one levels, and integrating the overlap region of the two Gaussian distributions. This integral

gives an approximation for the number of errors that would occur, even if no errors were actually detected. Though less precise than a direct measurement, this probabilistic approach requires far fewer data points to give an estimate of the BER. And since it does not require knowledge of the actual data sequence, this probabilistic method can be used in the field for rapid, continuous monitoring of performance.

TiSER is capable of generating eye-diagrams of extremely high-data rate signals, with high-fidelity, and at high-throughputs, making it an excellent candidate for BER measurement and performance monitoring. To demonstrate the capabilities, we integrated the TiSER oscilloscope into a packet switching network test-bed built and operated by the Lightwave Research Laboratory at Columbia University.

### 6.2.1 Probabilistic BER Estimation

When a digital data stream reaches a receiver, the receiver periodically samples the signal near the center of the bit window (or unit interval (UI)). Based on whether the sampled amplitude is above or below a threshold level near the 50% mark,  $V_D$ , the receiver reads the bit as a zero (low) or one (high). The BER is the probability of bit being read incorrectly by the receiver; that is, the probability for a sample in the one level to drop below  $V_D$ ,  $P_{Err,1}$ , plus the probability for a sample in the zero level to rise above  $V_D$ ,  $P_{Err,0}$ :  $BER = P_{Err,1} + P_{Err,0}$ . Of course, we are assuming that there are an equal number of ones and zeros in the sequence, which is a fair assumption for most real-world signals.

We can estimate  $P_{Err,1}$  and  $P_{Err,0}$  from the eye diagram of a data sequence, by assuming the amplitude noise on the one and zero levels follow Gaussian probability distributions,  $N(V, [V_1, \sigma_1])$  and  $N(V, [V_0, \sigma_0])$ , and integrating the portions of the distributions which cross incorrectly below or above the decision threshold,  $V_D$  [98]. That is:

$$P_{Err,1} = \int_{-\infty}^{V_D} N(V, [V_1, \sigma_1])dV = \frac{1}{2}erfc\left(\frac{V_1 - V_D}{\sigma_1\sqrt{2}}\right) \quad (6.1)$$

$$P_{Err,0} = \int_{V_D}^{\infty} N(V, [V_0, \sigma_0])dV = \frac{1}{2}erfc\left(\frac{V_D - V_0}{\sigma_0\sqrt{2}}\right), \quad (6.2)$$

where  $erfc(x)$  is the complementary error function. Although the BER will depend on

the decision level  $V_D$ , the optimum decision level, resulting in the minimum BER can be derived:  $V_D = (\sigma_0 V_1 + \sigma_1 V_0) / (\sigma_0 + \sigma_1)$ . In this case, the BER is given by:

$$BER = \frac{1}{2} \operatorname{erfc} \left( \frac{Q}{\sqrt{2}} \right) \quad (6.3)$$

$$Q = \frac{V_1 - V_0}{\sigma_1 + \sigma_0} \quad (6.4)$$

where the Q-factor is introduced for convenience as it is related to the electrical SNR and uniquely specifies the BER.

I wrote a program in MATLAB, which fits Gaussian profiles to the one and zero levels of an eye diagram and calculates the Q-factor and BER via Eq. (6.3). The UI is first split into 300 slices, and the Q-factor is calculated for each slice. The location of the maximum Q-factor is chosen as the center of the sampling window. For RZ-OOK signals, the standard sampling window for estimating the Q-factor is 20% of the UI, or 60 slices. From this centered 20% sampling window, more precise gaussian distributions are fit, and the final Q-factor and BER are estimated.

An example of the algorithm in practice is illustrated in Figure (6.5). A 40 Gb/s RZ-OOK  $2^{15} - 1$  PRBS data sequence was time-stretched by a factor of 24 by a TiSER system, and digitized. From the captured and recovered data, an eye-diagram was generated. The best fit Gaussian distributions for the one and zero levels are plotted next to the eye for illustration. The calculated Q-factor and BER were 4.1 and  $10^{-4.8}$  respectively. The dispersive fibers used in this TiSER system were 41 ps/nm and 1024 ps/nm, resulting in a dispersion penalty which distorted the original signal and increased the BER.



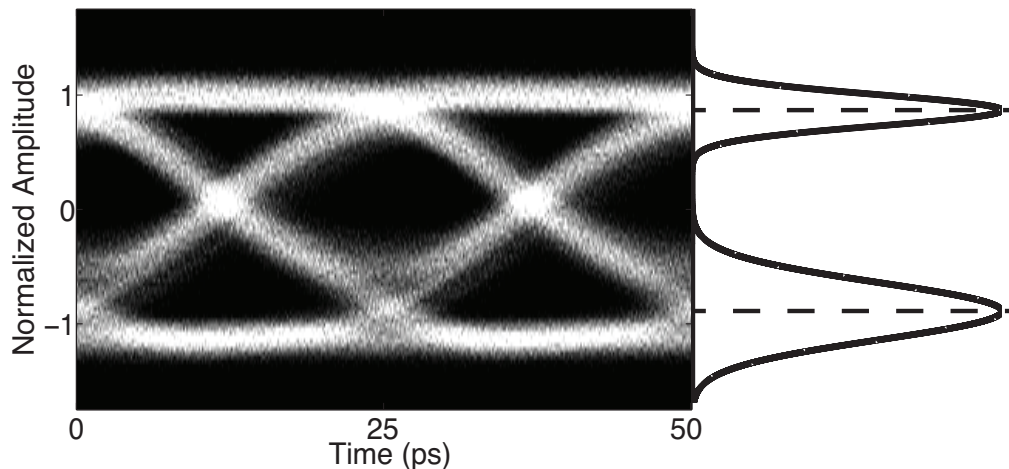

Figure 6.5: Eye-diagram of a 40 Gb/s RZ-OOK  $2^{15} - 1$  PRBS signal time-stretched by 24.

### 6.2.2 Integration in Optical Packet Switching Test-bed

The Lightwave Research Laboratory at Columbia University (headed by Dr. Keren Bergman), is performing active research on the future of optical networks. In particular, their goal is to improve the energy efficiency and bandwidths of optical networks to meet the growing demands of internet traffic. Towards this end they have designed a cross-layer communications framework, which will enable greater intelligence and network functionality on the optical layer through the development of a cross-layer optical switching node.

A critical component of this next generation optical network will be the ability to continuously, and rapidly monitor the performance of the optical packets as they are routed through the nodes. TiSER has been targeted as a potential candidate for such OPM applications. TiSER requires considerably less power than conventional oscilloscopes or BER testers (BERTs), because it uses slower, lower performance ADCs at the back-end. It can therefore be reasonably scaled to monitor many nodes across the network simultaneously. Additionally, TiSER boasts a larger throughput than conventional equivalent time oscilloscopes ( $>2$  GB/s vs hundreds of kB/s). TiSER is therefore capable of generating eye-diagrams and estimating BER on individual optical packets of only 10's of microseconds. This is an important capability, since consecutive optical packets may have been routed

through different nodes in the network, and only TiSER would be able to decipher a single, faulty packet interleaved between faithful packets. Finally, with its real-time capabilities, high-resolution, and low jitter, TiSER captures eye-diagrams with supreme fidelity.

In an experiment performed at Columbia University, we integrated TiSER into the packet-switching network test-bed [48]. The goal was to prove that TiSER could accurately recover eye-diagrams and determine the quality of 40 Gbps optical data packets being routed in the network. The signal consisted of 32  $\mu s$  wavelength striped optical packets ( $8 \times 40 \text{ Gb/s}$ ), RZ-OOK  $2^{15} - 1$  PRBS). An individual wavelength channel ( $\lambda = 1538.98 \text{ nm}$ ) was tapped before the network, detected by a PD, and time-stretched by TiSER. An eye-diagram was generated and BER curve plotted for various optical powers at the PD (Fig. 6.6). The wavelength striped packets were next routed through the optical switching fabric. At the output, the same wavelength channel was tapped, detected, sent through a limiting amplifier, and captured by TiSER. Again, eye-diagrams and BER curves were generated (Fig. 6.6).

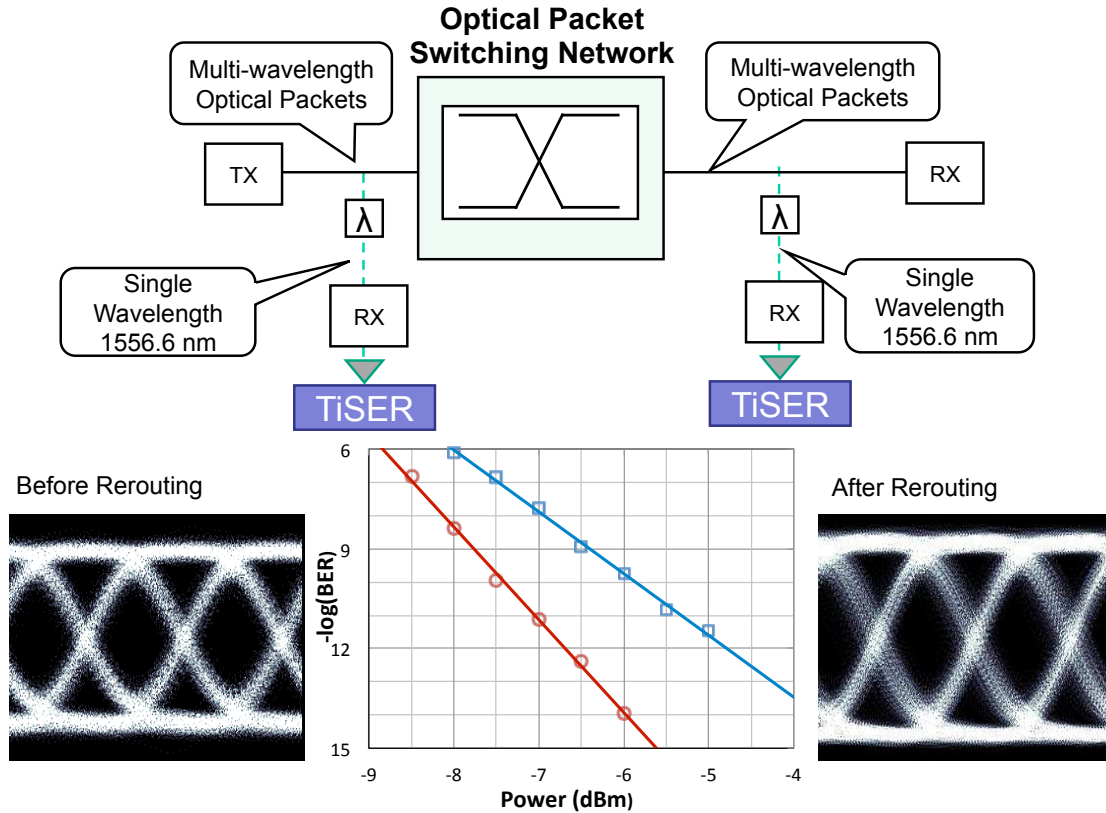

Figure 6.6: TiSER was inserted into the packet-switching network test-bed at Columbia University as an optical performance monitor. TiSER successfully generated eye-diagrams and measured BER from  $32\mu\text{s}$  packets of data.

As illustrated, TiSER successfully characterizes the quality of the data before and after routing. Using a commercially available BERT, the BER was found to be error free, verifying TiSER's results. However, compared to a measurement on the BERT which took several minutes, TiSER was able to determine the same information with  $32\mu\text{s}$  worth of data.

### 6.3 Instantaneous High-Resolution Wide-band Spectral Sweep

In addition to analyzing wide-band signals in the time domain, TiSER can also be used for characterizing signals in the spectral domain. Because TiSER captures a window of real-time data - unlike an equivalent time oscilloscope - we can take the fast Fourier transform

(FFT) of each captured window to analyze the spectral domain. Additionally, by slowing down signals before digitization, TiSER allows for instantaneous spectral sweeps across an enormous bandwidth, while using an ADC that otherwise would have only been able to capture a small slice of the full spectrum. Other architectures to perform such wide-band, instantaneous spectral sweeps rely on complicated, bulky, energy consuming RF analog electronics.

One time-stretched pulse from TiSER can be considered as making a full spectral sweep. The time for the sweep is the pulse period of the MLL. The spectral resolution after FFT is limited nominally to the inverse of the time-aperture. However, we can use digital signal processing techniques to improve the frequency resolution, if the signal is sparse in the frequency domain.

When performing an FFT on a finite window of data, the frequency resolution is limited. Using a simple rectangular window, if a frequency component of the input signal lies directly on one of the bins of the FFT (that is, the periodicity of the signal is an integer fraction of the window length), the FFT will give an accurate description of the spectrum [6.7\(a\)](#). However, if the frequency component does not lie on one of the FFT bins, the energy in that signal tone spreads across multiple bins. The resolution of our spectral measurement is reduced [6.7\(b\)](#). A window function, such as a Hann window, reduces the spectral leakage across so many FFT bins [6.7\(c\)](#).

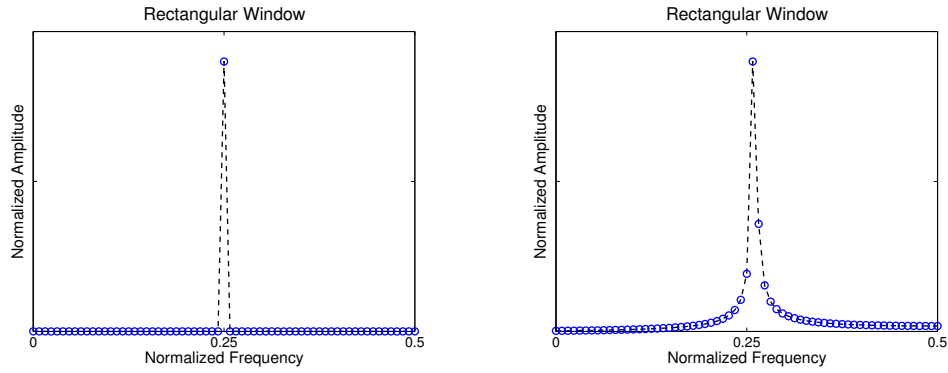

(a) When a signal frequency's periodicity is an integer fraction of the window length, the FFT produces an accurate spectral profile. (b) When a signal frequency's periodicity is not an integer fraction of the window length, spectral energy leakage occurs.

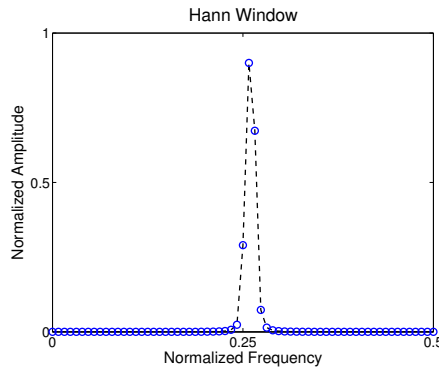

(c) Using a Hann window reduces spectral leakage

A powerful technique, developed by Dr. Asad Madni [99, 100, 101, 102], uses quadratic interpolation in the spectral domain to improve the spectral resolution. If we are interested in finding the frequency of an input data signal, we can look for the peak in the FFT. However, if the frequency does not lie directly on a frequency bin, we will have an error, which could be as bad as one half the frequency bin separation (or  $\Delta f = 1/(2T)$ ), where  $T$  is the window duration. If we locate the peak, we can fit a quadratic through the peak and the next adjacent bins 6.7. The peak of the quadratic interpolated function will lie nearer to the true frequency of the original signal. This technique is used in the AN/PSM-40 antenna test set and the Transmission analyzer <sup>®</sup>.

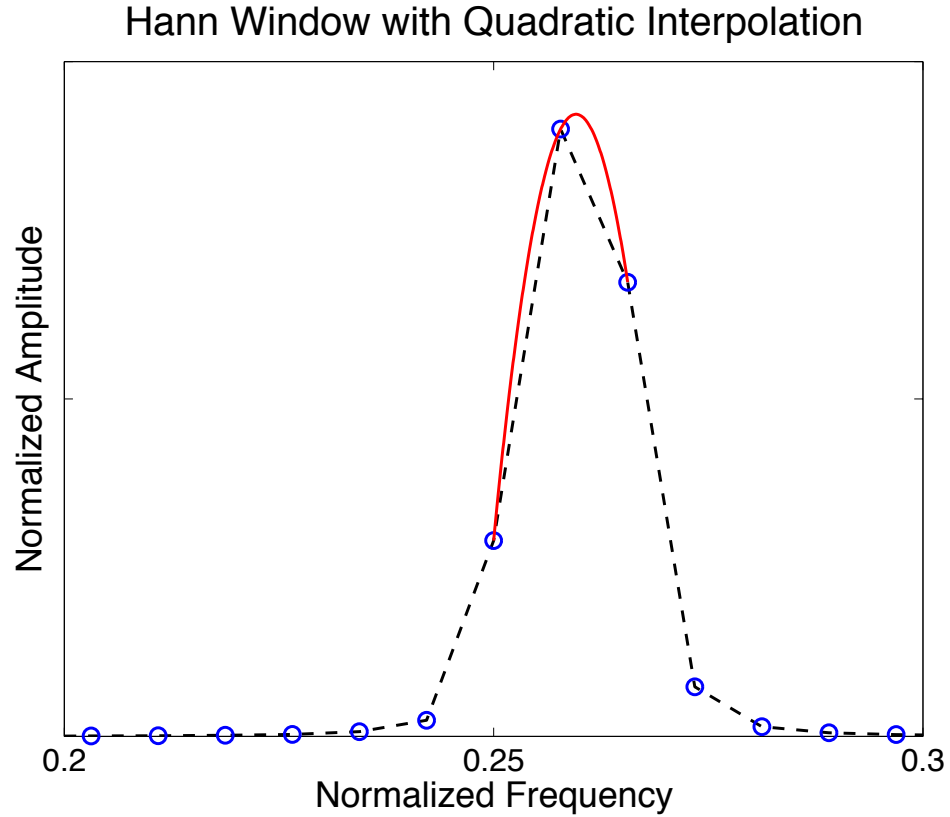

Figure 6.7: Using quadratic interpolation and a windowing function, we can improve the spectral resolution of our frequency measurement.

A simulation was performed for TiSER. Assuming actual experimental values from our TiSER prototype:  $D1 = 20$  ps/nm,  $D2 = 941$  ps/nm, and 20 nm of optical bandwidth, we achieve a frequency resolution of  $\pm 125$  MHz, over 40 GHz of instantaneous bandwidth with a 37 MHz sweep rate. The Hann window with interpolation improves our spectral resolution ten-fold.

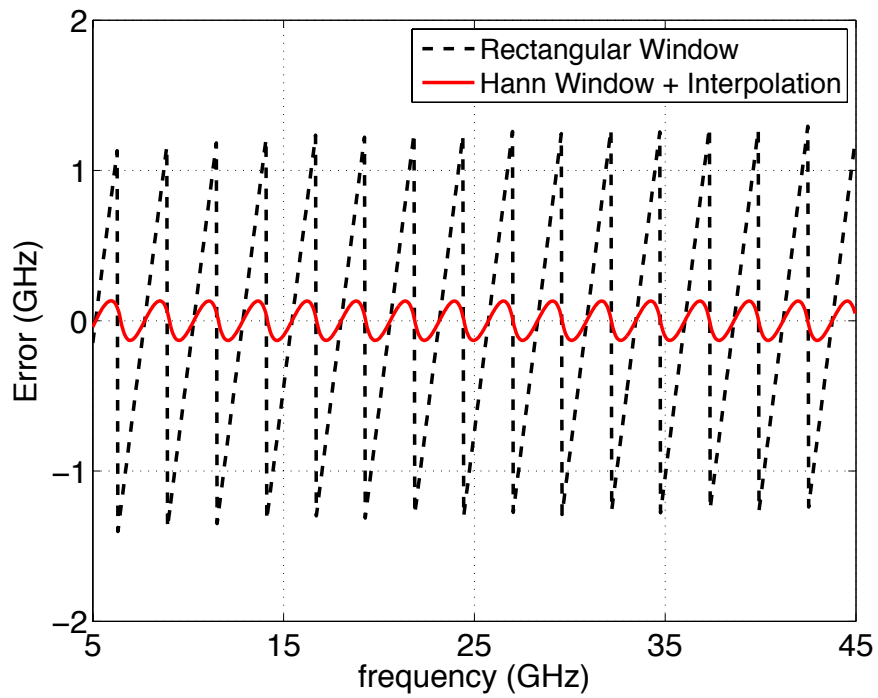

Figure 6.8: TiSER simulation. Over a 40 GHz frequency range, the frequency error was calculated using the peak from the rectangular window and with quadratic interpolation using a Hann window. Simulations indicate  $\pm 125$  MHz resolution with a sweep time of 37 MHz.

## CHAPTER 7

# Time-stretch Accelerated Real-time Digital Signal Processing

In this chapter I discuss our work in developing a real-time backend for TiSER. TiSER captures ultrahigh-bandwidth data at high-throughput, and in conjunction with digital signal processing, recovers the original time-stretched signal. All previous demonstrations of TiSER have implemented digital signal processing in software on a PC. The data transfer to the hard disk and the software processing requires a considerable amount of time. Additionally, since the data must be stored before analysis, the total data handling capacity is limited to the amount of random-access memory directly available to the ADC (typically no more than a few giga-bytes). We have developed a custom digitizer board with an 8-bit 3 GS/s ADC and a FPGA (field programmable gate array), which is capable of real-time processing of time-stretch data as it streams out of the ADC. We successfully developed a hardware description in Verilog to perform all necessary digital processing of the time-stretched data. The full integrated TiSER system reaches an instantaneous real-time processing throughput of 1.5 tera-bits per second (Tbps). As an application for this demonstration, we focused on capturing digital data and generating eye-diagrams for the purposes of real-time performance monitoring. The newly developed real-time electronic back-end described here transforms TiSER from a laboratory demonstration to a valuable real-world tool.



## 7.1 Introduction

The photonic time-stretcher (TiSER) [34, 35, 36, 37] enables ultra-high throughput and precision capture of wide-band analog signals by slowing them down before digitization. The streaming digital data then must be processed to recover the original analog signal. In all previous demonstrations of TiSER, the data capture and digital processing steps were performed on separate platforms. The digitized data streamed from the analog-to-digital converter (ADC) to a random access memory (RAM) bank, which was typically limited to 2 GB or less, and saved to a local hard disk. The stored data then had to be physically transferred to a work-station (PC) for final processing in software. Such systems, though acceptable for testing the photonic time-stretch front-end, are severely lacking in data handling capacity and latency, and thus inappropriate for most real-world applications. Typical write speeds to hard disks are currently limited to 200 MB/s. At this rate, it takes a minimum of 10 seconds to transfer 2 GB of captured data. The subsequent transfer time to the separate work station can take even longer (USB 2.0 speeds top out at 35 MB/s one way). Finally, the processing speed in software, even with optimized algorithms, is slower than the original data throughput because of the fundamentally serial nature of CPU computing. With such systems, the time between data capture and completed processing can take up to several minutes for only 2 GB of data at a time, presenting a major drop in throughput as compared to the original data stream.

Many real-world applications call for larger data handling capacity and lower latency than the previous implementations of TiSER could provide, as described above. For instance, performance monitoring of digital data in communication networks requires continuous, rapid eye-diagram formation, analysis, and bit-error-rate (BER) estimation, so that corrective measures can be taken with minimal loss of data [103, 94, 96]. In electronic surveillance and counter measures for the military, rapid, wide-band spectral domain sweeps are required in order to respond quickly to attacks [14, 15]. And for high-content screening and rare event detection, such as in cellular biology, it is typically not possible to save the huge amounts of data being analyzed. Instead, events of interest must be detected

in real-time and down selected from obvious background data. The photonic time-stretch pre-processor is fundamentally capable of addressing all these applications, but is currently limited by the electronic back-end bottleneck.

We have developed a TiSER system with an electronic back-end, which combines the digitization and post-processing onto a single physical platform. The digitized data streams directly to a digital processing hardware device, located on the same board, which keeps up with the high-speed data input through massive parallel computing. With such a system, the read/write transfer bottlenecks and software processing latencies are eliminated. The captured time-stretched data can be digitally processed and compressed in real-time, sent directly to a large local RAM bank, or streamed to a monitor or PC for final analysis.

In this prototype system, we implemented the DSP on a field programmable gate array (FPGA). FPGA's are integrated circuits with millions of reconfigurable logic blocks and numerous high speed programmable I/O terminals [104]. Operating at high-clock rates (hundreds of MHz) and enabling massively parallel computing, FPGAs are the perfect candidates for high-throughput data processing and rapid prototyping. However, porting DSP algorithms originally designed in software, to the real-time, parallel realm of hardware computing is a notoriously challenging task [105]. A large portion of this work involved designing an optimized FPGA hardware to perform the necessary processing of the time-stretched data. This included synchronizing the FPGA to the time-stretch pulse train, characterizing the spectral envelope, and dividing the envelope from each incoming pulse to recover the original signal. Certain functions, such as modulo operation and division - trivial for software - are resource intensive in the FPGA. Much work went into ensuring a high operating clock speed, and efficiently utilizing the finite logic and memory resources.

We focused on capturing digital data at 12.5 and 40 giga-bits per second (Gb/s). The recovered data, along with synchronization information is streamed to a PC where eye-diagrams can be generated and analyzed in real-time. Important performance metrics can be determined from eye-diagrams, such as bit error rate (BER) [98], rise-fall times, eye-opening, and jitter. Estimating these parameters quickly is important for active performance monitoring in high-speed networks [103, 94, 96].

## 7.2 System Overview

The prototype system developed and described here included a photonic time-stretch front-end and a custom designed digitizer board with an ADC, FPGA, RAM bank, and high-speed interfaces to a PC (Fig. 7.1). A pseudo-random bit sequence (PRBS) generator was used as the signal under test.

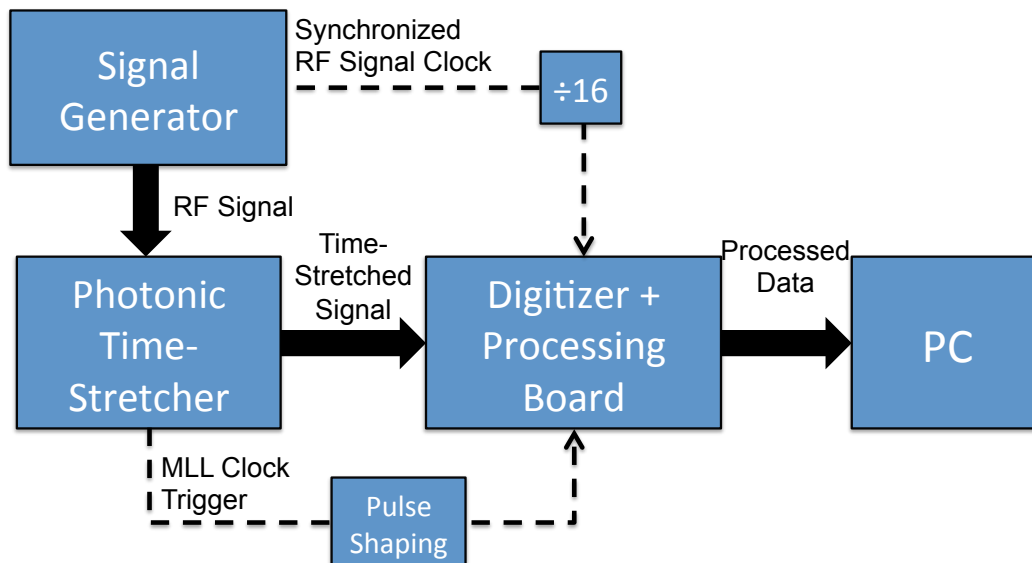

Figure 7.1: High level block diagram of real-time TiSER prototype and test setup. The signal generator consisted of a pseudo-random bit sequence (PRBS) generator. The board was directly clocked by the signal clock, running at 20 GHz, divided by 16. The time-stretch mode-locked laser (MLL) trigger required pulse shaping to meet the requirements as an input to the FPGA.

### 7.2.1 Photonic Time-stretch Front-end

The photonic time-stretch front-end (Fig. 7.2) consisted of a MLL operating at  $\sim 36.7$  MHz with 30 mW output power, and  $<1$  ps pulse width. The optical pulses were pre-stretched by a dispersive fiber (D1) of 10 or 20 ps/nm (depending on the signal bandwidth). A polarization controller was used to align the polarization before the Mach-Zehnder modulator (MZM). The MZM was biased at the quadrature point and driven by the signal generator,

modulating the RF signal onto the pre-dispersed optical pulse train. A second dispersive fiber (D2) of 984 ps/nm dispersed the modulated pulses. The stretch factor is determined by  $M=1+D2/D1$ , in this case equal to  $\sim 50$  or  $100$ . An optical band pass filter (OBPF) carved out an 18 nm portion of the optical spectrum centered at 1570 nm. The optical signal, with  $\sim 500\mu\text{W}$  power, was then captured by a photo-detector with 0.85 A/W responsivity and transimpedance gain of  $500\Omega$ . A low noise amplifier (LNA), of gain 26 dB and 3.2 dB noise figure, amplified the time-stretched RF signal in order to fill the full scale voltage of the ADC ( $\sim 1\text{V}$ ). A bias tee was used to shift the signal into the range of the ADC ( $-500\text{mV}$  to  $+500\text{ mV}$ ).

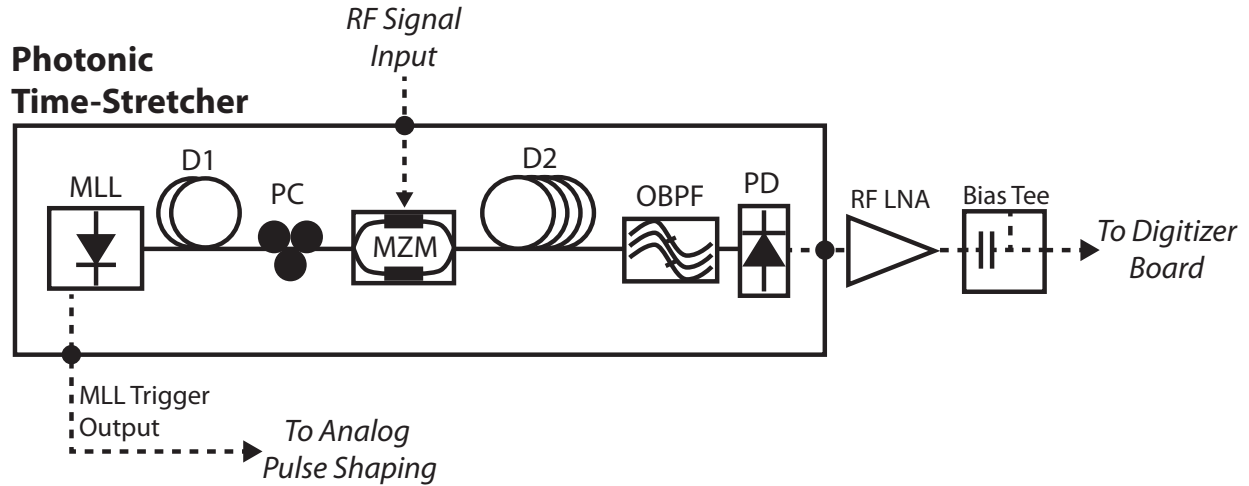

Figure 7.2: Schematic of the photonic time-stretch frontend. MLL: Mode Lock Laser, D1: first dispersive fiber, PC: polarization controller, MZM: Mach-Zehnder modulator, D2: second dispersive fiber, OBPF: optical band-pass filter, PD: photo-detector, RF LNA: RF low noise amplifier

### 7.2.2 Digitizer/Processing Board

The custom designed digitizer board (Fig. 7.3) used an 8-bit ADC (National Semiconductors ADC083000), which consisted of two sample interleaved ADCs, for a total sampling rate of double the input clock rate (maximum 3 giga-samples per second (GS/s)). The digitized outputs of the ADC are demultiplexed to four 8-bit ports, each of which outputs four

bytes of digitized sample points at double the data rate (DDR) of a 312.5 MHz differential output clock. The differential output clock from the ADC is the input clock to the Xilinx Virtex 6 XC6VLX240T FPGA, which is further divided by two to generate 156.25 MHz, the main computation clock of the FPGA. Hence, the FPGA device captures 16 ADC sample points per clock cycle. The FPGA output from the digitizer board can be interfaced to the computer using a USB 2.0, USB 3.0, Gigabit Ethernet, or SATA interfaces. The digitizer board has 2 GB of DDR-III RAM for storing data from the FPGA. A DDR controller IP core has to be instantiated into the FPGA design to use the DDR-III RAM. The digitizer board is also equipped with an on-board clock generator using a PLL that generates a 1.5 GHz clock to be used for 3 GS/s operation of the ADC. However, in this prototype system, the ADC was directly clocked by the 20 GHz signal clock, which we divided by 16 to reach the operating range of the ADC (1.25 GHz).

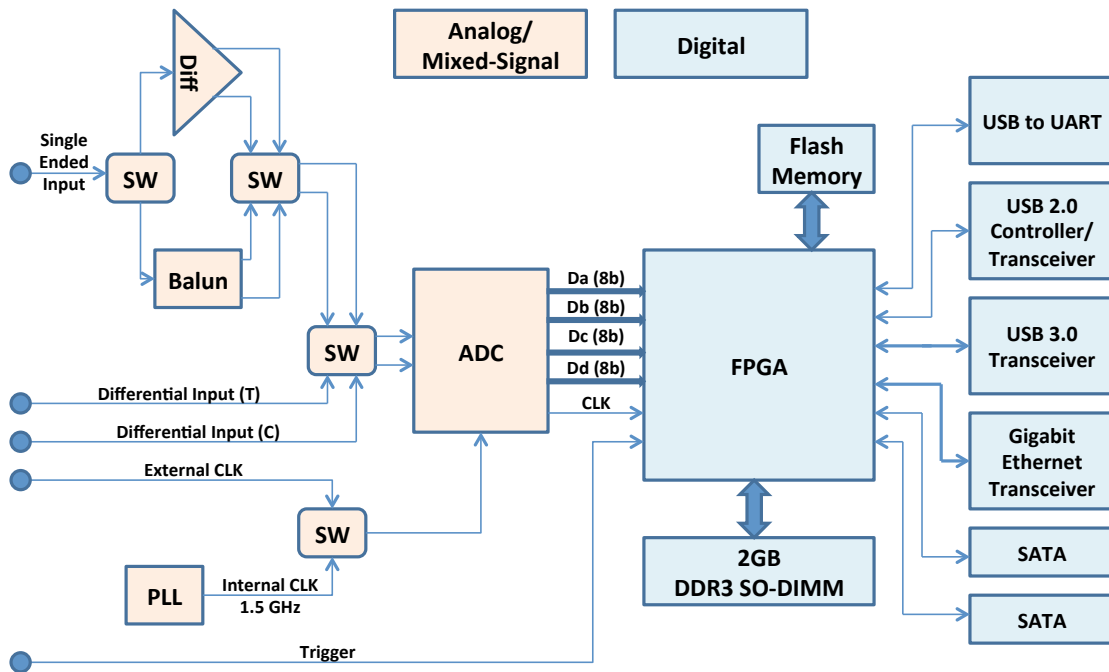

Figure 7.3: Block Diagram of the Custom Designed 3 GS/s Digitizer Board

The analog MLL trigger pulses are fed to one of the general purpose I/O terminals of the FPGA, and sampled at four times the clock rate (one fourth the ADC sampling rate). Pulse shaping was necessary to properly trigger the FPGA. Part of the output power from

the MLL is detected by a photo-detector (PD), which generated a synchronized electrical impulse response train. The resulting pulses were too short for the FPGA to detect. A 117 MHz analog RF filter, inverting amplifier, low-noise amplifier (LNA), and bias tee reshaped the impulse response train so as to properly trigger the FPGA(Fig. 7.4).

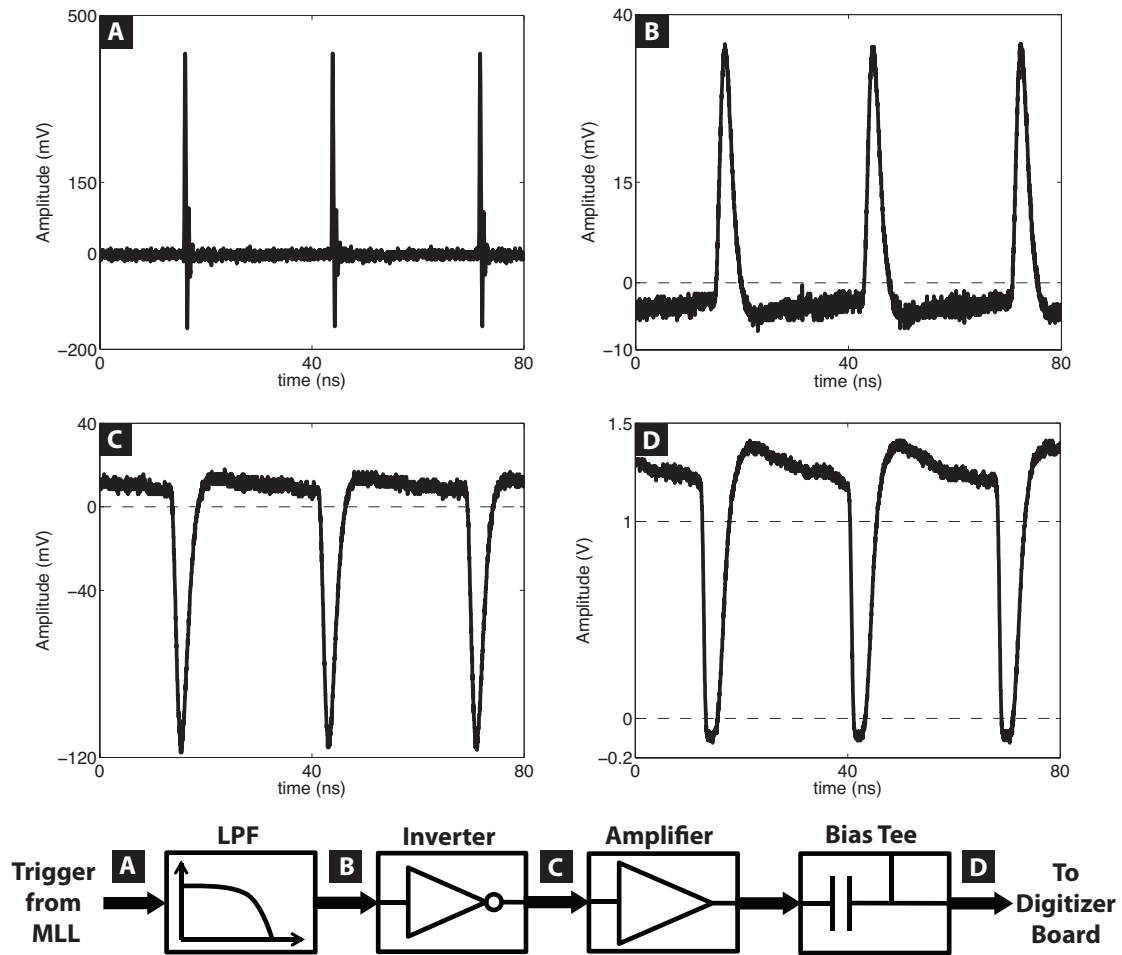

Figure 7.4: Analog RF electronics reshaped the synchronized impulse response train from the MLL to meet the requirements for an input to the FPGA. (A) Raw impulse response output from the PD in the MLL. The pulse width ( $< 1ns$ ) is too short to trigger the FPGA. (B) A 117 MHz filter broadened the pulses, while significantly attenuating the overall power. (C) An inverting amplifier inverted the pulses, effectively broadening the top portion of the pulse. (D) Finally a 500 MHz, 25 dB gain low noise amplifier (LNA) and bias of 1.1V brought the pulses to the necessary range to trigger the FPGA.

### 7.3 FPGA Logic Design

The logic design implemented on the FPGA can be segmented into four modules, running in parallel and pipelining data to each other (Fig. (7.5)). The first module continuously determines the MLL repetition rate for synchronizing the FPGA to the time-stretch pulses. The second module uses the precisely determined repetition rate to perform a modulo operation in the time domain, separating each time-stretch pulse into its own frame. Each frame is then sent to a third module, which averages a 1024 set of consecutive frames to recover the time-stretch spectral envelope. In the fourth module, the time-stretch pulses are divided by the previously determined spectral envelope, recovering the original signal.

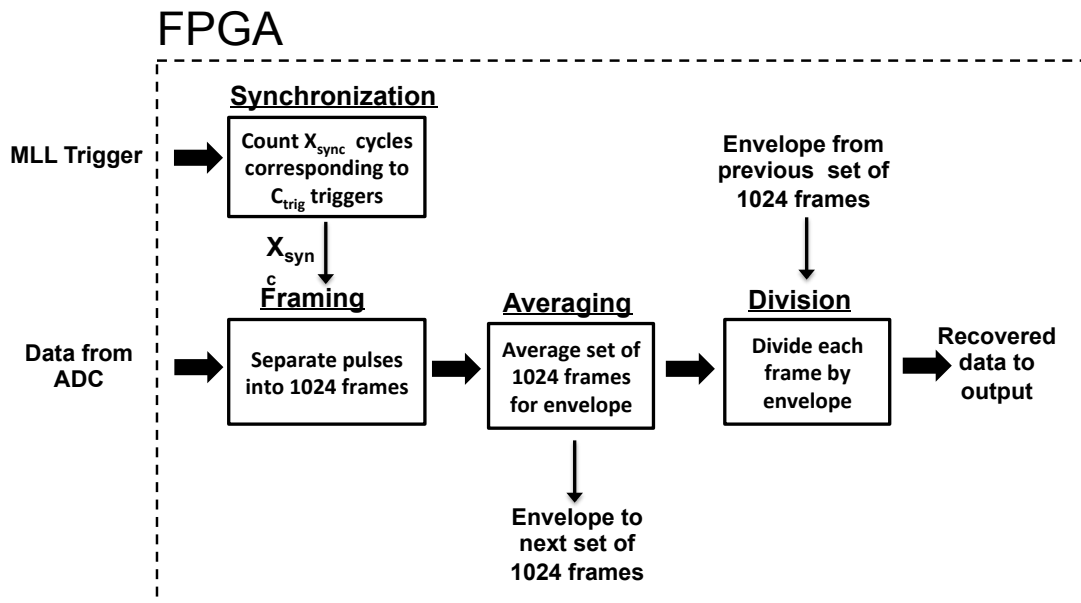

Figure 7.5: Flow chart of DSP in FPGA

Table 7.1: List of variables used in logic design descriptions

Variable	Description
$C_{\text{trig}}$	The fixed number of MLL trigger pulses counted in the synchronization module.
$X_{\text{sync}}$	Synchronization Counter: Counts the number of clock cycles corresponding to $C_{\text{trig}}$ MLL trigger pulses.
$X_{\text{trig}}$	Trigger Counter: Keeps track of the number of MLL trigger pulses. When $X_{\text{trig}}$ reaches $C_{\text{trig}}$ , the synchronization module stores $X_{\text{sync}}$ and resets.
$N_{\text{sample}}$	The number of samples since the first trigger in the framing module. Resets when 1024 frames are reached.
$T_{\text{MLL}}$	The MLL period, in sample points.
$N_{\text{clk}}$	Keeps track of the clock cycles in the framing module. Used for modulo operation.
$N_{\text{frame}}$	Frame Counter: Increments each time a frame is formed in the framing module.

### 7.3.1 Synchronization

The synchronization module continuously calculates the MLL pulse period by counting a large number of input trigger pulses,  $C_{\text{trig}}$  and dividing it from the corresponding number of FPGA clock cycles,  $X_{\text{sync}}$ , termed the synchronization count (see Table 7.1 for a list of variables used for detailing the logic design). The synchronization count, for a given trigger count, specifies the average MLL pulse period, from which the logic can perform all necessary synchronization steps in the subsequent modules.

The synchronization module state diagram is illustrated in Figure 7.6. A state machine monitors the incoming MLL trigger pulses, and at the 1.1 V level rising edge, triggers the counter  $X_{\text{trig}}$  to increment. Simultaneously, a second state machine increments the syn-



chronization counter,  $X_{\text{sync}}$  every clock cycle. When the trigger counter reaches a specified number,  $C_{\text{trig}}$ , the synchronization count is stored and both counters are reset. With a MLL repetition rate of  $\sim 36.7$  MHz and FPGA clock rate of 156.25 MHz, the MLL pulse period is given by  $X_{\text{sync}}/C_{\text{trig}} \approx 4.25$  clock cycles. For ease of logic implementation,  $C_{\text{trig}}$  was chosen to be a power of two, i.e.  $\log_2 C_{\text{trig}}$  is an integer. In this case, division is simply a shift of the decimal point, eliminating the need for a divider core.

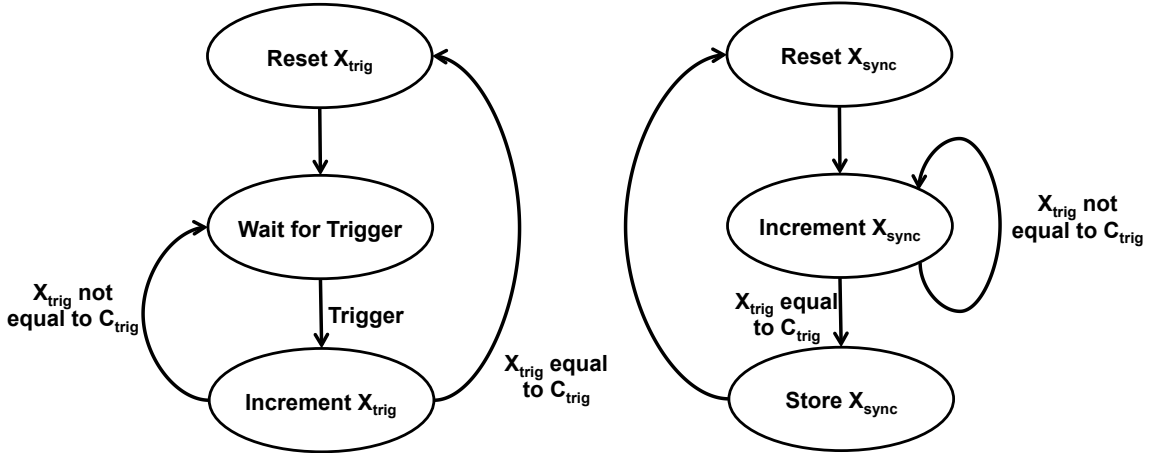

Figure 7.6: State machine diagram for the synchronization module.

Intuitively, a larger trigger count allows for a more accurate determination of the MLL pulse period. Quantitatively, we can attribute the majority of the inaccuracy in synchronization to the integer granularity of the synchronization counter,  $X_{\text{sync}}$ . The MLL pulse period, in ADC sample points, is given by  $T_{\text{MLL}} = (X_{\text{sync}}/C_{\text{trig}}) \times 16 \approx 69$ . A factor of 16 accounts for the 16 ADC sample points per clock cycle. With a maximum error in  $X_{\text{sync}}$  of one clock cycle, the uncertainty in  $T_{\text{MLL}}$  is given by  $16/C_{\text{trig}}$ . We can improve the accuracy by averaging over a larger number of MLL triggers. However, the larger the averaging time, the slower the response is to drifting of the MLL repetition rate. The synchronization response time is given by  $C_{\text{trig}}/36.7 \text{ MHz} = C_{\text{trig}} \times 27 \text{ ns}$ . To account for temperature fluctuations, we targeted a response time of no greater than 100 ms, or  $\log_2 C_{\text{trig}} < 22$ .

### 7.3.2 Framing

The next module takes the continuous data from the ADC and separates the time-stretch pulses into frames of 48 samples each. We determined that frames of 48 ADC samples, or 3 clock cycles worth of data, was sufficient to capture the useful portion of each optical pulse (depending on the dispersive fibers and optical bandwidths used). Based on the MLL trigger, the logic can determine the approximate time to begin storing data into frames. However, the MLL trigger is sampled at only one-fourth the ADC sampling rate, so using the MLL trigger exclusively to determine the starting point for each frame would lead to an unacceptable jitter of 4 sample points. Instead, once the module is triggered and determines the approximate frame starting point, subsequent starting points are calculated using the synchronization count from the previous module. By performing  $N_{\text{sample}}$  modulo  $T_{\text{MLL}}$ , with  $N_{\text{sample}}$  the number of samples since the first trigger, the logic knows precisely at what time to begin the next frame (to within one sample point resolution).

Modulo is a logic and memory resource intensive operation. We developed an optimized hardware for this purpose, which used significantly fewer resources than a conventional modulo core. The algorithm performs modulo operation through  $N_{\text{sample}}$  modulo  $T_{\text{MLL}} = N_{\text{sample}} - T_{\text{MLL}} \times \text{floor}\{N_{\text{sample}}/T_{\text{MLL}}\}$ . Instead of using division, the logic equivalently determines  $\text{floor}\{N_{\text{sample}}/T_{\text{MLL}}\}$  by storing a counter,  $N_{\text{frame}}$ , which increments each time a frame is formed. A second counter,  $N_{\text{clk}}$ , increments upon each clock cycle such that  $N_{\text{sample}} = 16 \times N_{\text{clk}}$ . The operation performed in hardware is as follows:

$$\begin{aligned}
 N_{\text{sample}} \text{ modulo } T_{\text{MLL}} &= N_{\text{sample}} - T_{\text{MLL}} \times \text{floor}\{N_{\text{sample}}/T_{\text{MLL}}\} \\
 &= 16 \times N_{\text{clk}} - \frac{X_{\text{sync}}}{C_{\text{trig}}} \times 16 \times N_{\text{frame}} \\
 &= 2^4 \times N_{\text{clk}} - \frac{X_{\text{sync}}}{2^{\log_2 C_{\text{trig}} - 4}} \times N_{\text{frame}} \\
 &= (2^{\log_2 C_{\text{trig}}} \times N_{\text{clk}} - X_{\text{sync}} \times N_{\text{frame}}) / 2^{\log_2 C_{\text{trig}} - 4}. \quad (7.1)
 \end{aligned}$$

The final expression in Eq. (7.1) is optimized to use minimal logic resources, since it includes only one non-trivial multiplication and one subtraction. To further minimize resources, the multiplication  $X_{\text{sync}} \times N_{\text{frame}}$  is performed in practice by incrementing a counter by  $X_{\text{sync}}$

each frame. When the result of Eq. (7.1) is less than 16, the hardware is triggered to begin a frame, and the numerical result indicates precisely at which sample in the clock cycle to begin. The state machine diagram of the framing module is illustrated in Figure 7.7.

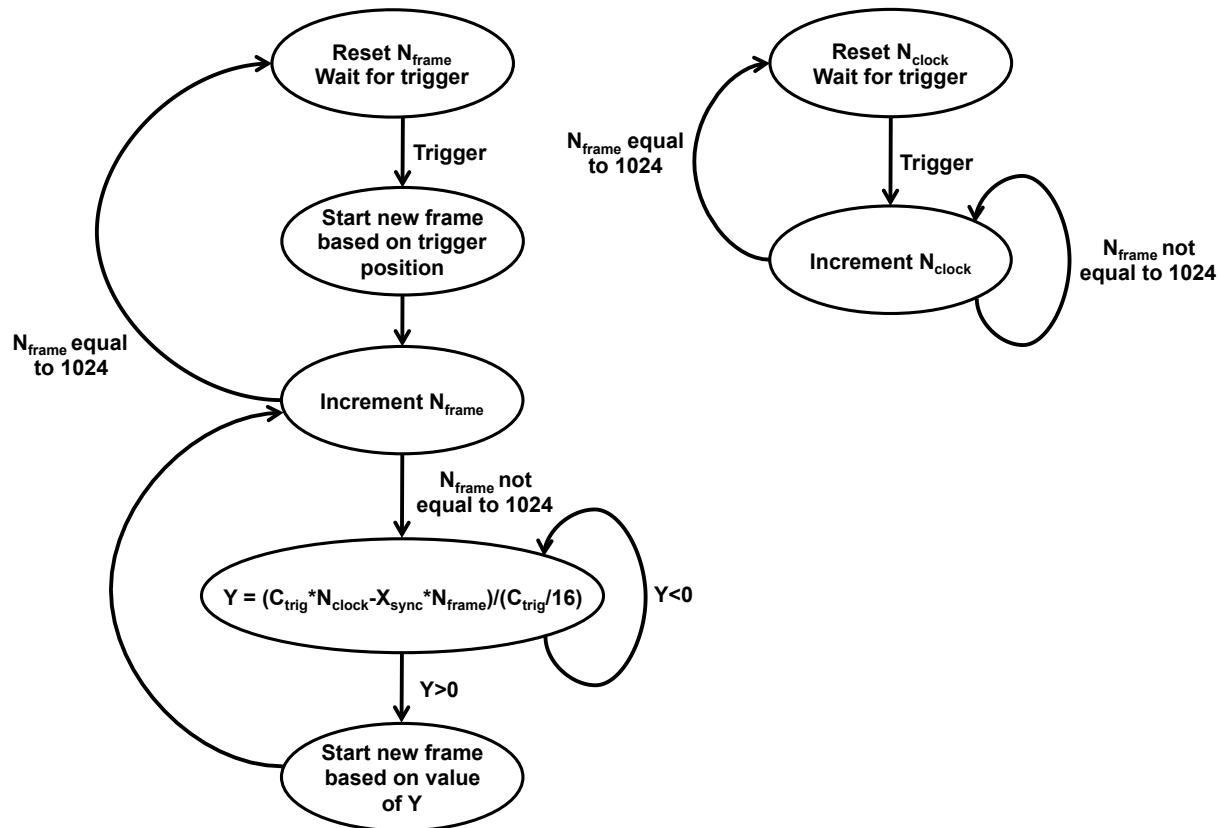

Figure 7.7: State machine diagram for the framing module.

We can visualize and quantify the accuracy in synchronizing the frames to the MLL pulses by overlaying consecutive frames (see Fig. 7.8). The implemented modulo computer truncates the result, effectively rounding to the lowest integer. This integer rounding limits the resolution with which the time-stretch pulse can be synchronized, resulting in a minimum of one-sample-point jitter. Additional jitter is caused by error in calculating  $N_{\text{clk}}$ . As the modulo operation is performed, the deviation from the true starting point accumulates, causing a monotonic walk off of the frame starting. Resetting the frame starting point after a set amount of windows reduces the walk off jitter. We chose to perform modulo operation on sets of 1024 frames before resetting the starting position. The average walk-off jitter is therefore given by  $1/2^{\log_2 C_{\text{trig}} - 14}$ . The hardware description

was parameterized for variable  $C_{\text{trig}}$ . We chose to use  $\log_2 C_{\text{trig}} = 21$  as this choice minimized the jitter while maintaining a sub 100 ms response time. The corresponding jitter due to walk off is approximately .008 sample points.

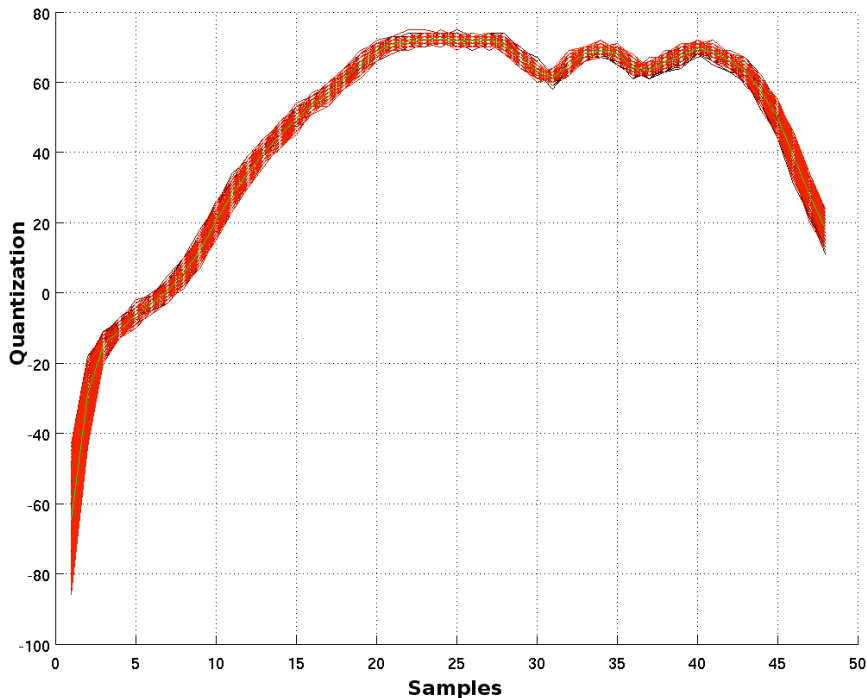

Figure 7.8: 330 overlaid frames of unmodulated time-stretched pulses. Illustrates the successful synchronization of the FPGA to the MLL

### 7.3.3 Averaging

The next module recovers the spectral envelope, upon which the original analog signal is modulated. After time-stretching, each pulse being fed to the FGPA is of the form

$$Input(t) = Env(t) [1 + Sig(t)] \quad (7.2)$$

where  $Env(t)$  is the spectral envelope of the MLL pulse after dispersion, and  $Sig(t)$  is the slowed down signal of interest. We first must characterize the spectral envelope and then divide each modulated pulse by this envelope. The signal being detected is generally AC coupled and asynchronous with the time-stretch clock. In such cases, averaging over many pulses,  $N_p$ , eliminates the modulated data, i.e.  $\sum_{i=1}^{N_p} Sig_i(t) = 0$ , leaving only the spectral

envelope. To ensure we calculated the envelope accurately, we needed to average over a sufficient number of pulses. We chose  $N_p = 1024$ , with a power of two again to obviate division and minimizing logic resources.

In Figure (7.9) we plot the RMS deviation from the true envelope (average of  $> 3000$  frames), after averaging over different numbers of frames. The deviation decreases with increasing number of frames, but begins to flatten out around 1000, justifying our choice of 1024. The plot in Figure (7.9) may vary for different signals, and a larger number of averages may be required.

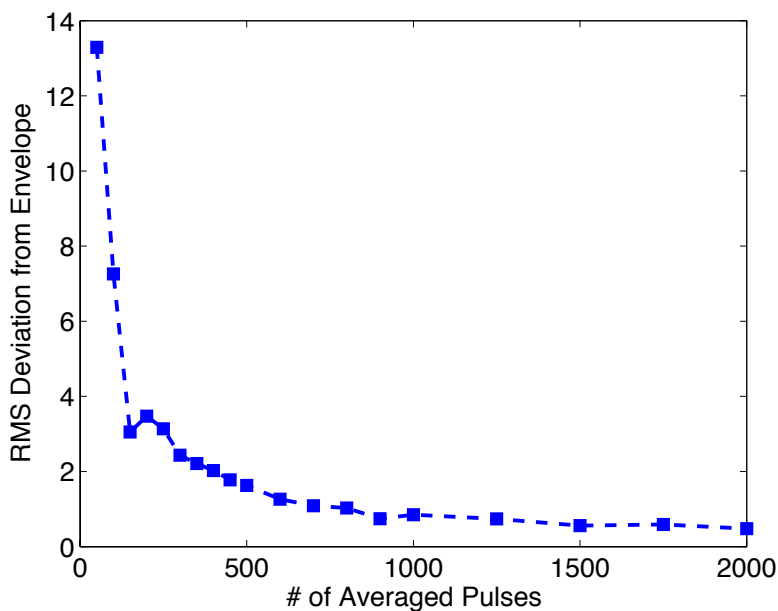

Figure 7.9: RMS deviation from the true envelope was calculated after averaging over varying numbers of pulses. The general trend is a more accurate recover of envelope for large number of averages, with diminishing returns beginning around 1000.

### 7.3.4 Division

The final module performs single precision floating point (SPFP) division, which is the most computationally intensive of all the operations performed on the FGPA. The fixed point data is first converted to SPFP in IEEE 754 format which uses uses 32 bits, with a 24-bit mantissa and an 8-bit exponent. The floating point IP core provided by Xilinx was

used to divide each frame by the spectral envelope determined from the averaging block. The maximum clock cycle latency of the divider core is equal to the mantissa bit width plus four; in this case 28 clock cycles.

The current prototype logic design used a divider core which dropped three out of every four pulses. The total throughput was decreased by a factor of four. A higher throughput divider can be implemented in the future, though at the cost of increased use logic resources. Alternatively, further tests may indicate that conversion to SPFP is not required, and a fixed point divider may be sufficient. A fixed point divider core would require much fewer resources and avoid a drop in throughput.

## 7.4 Results

The FPGA outputs each 48 sample point frame of recovered data and corresponding synchronization count using eight 18 bit wide FIFOs, outputting 2 bytes worth of data each. The data is then transferred to the PC over USB 2.0. A MATLAB code uses the synchronization count to generate eye-diagrams of the recovered data, which are presented in Figures 7.10(a) and 7.10(b). Because we clocked the ADC/FPGA with PRBS clock, we knew exactly how many samples made up a single unit interval (UI) of the PRBS signal. Each eye-diagram consisted of approximately 2500 sample points. We are currently limited in the number of sample points that can be transferred to the PC at a time because we used the USB 2.0 interface.

The jitter present in the eye-diagrams can be attributed primarily to the one-sample point jitter of the framing module. For 12.5 Gb/s data, divided by 50, the one-sample point jitter corresponds to one-eighth of a UI. For 40 Gb/s data, divided 100, the one-sample point jitter corresponds to approximately one-sixth of a UI. Future logic can implement interpolation to reduce the one-sample point jitter upon framing, potentially improving the quality of the recovered eye-diagrams.

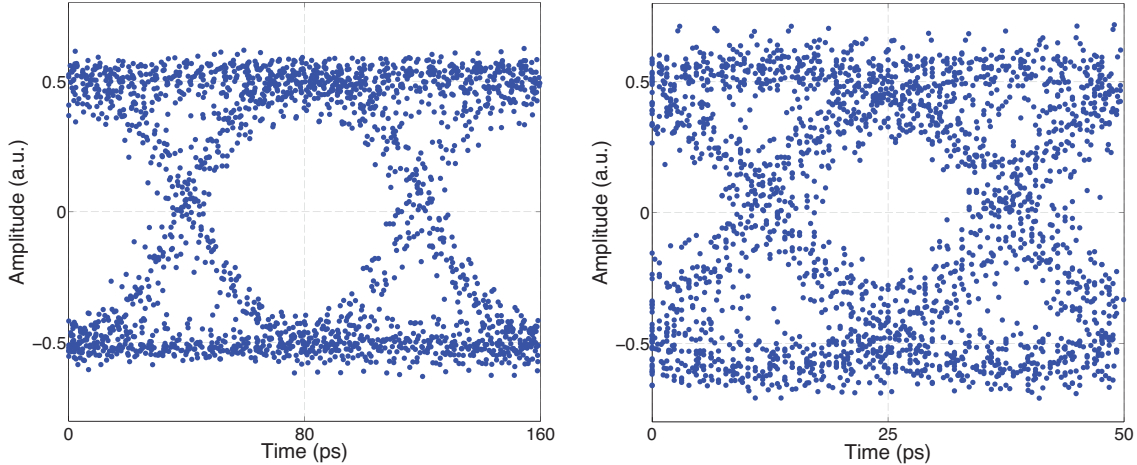

(a) 12.5 Gb/s Eye-diagram, stretched by 50

(b) 40 Gb/s Eye-diagram, stretched by 100

### 7.4.1 Device Utilization Summary

Because of extensive optimization, the entire logic implemented on the FPGA utilized only a small portion of the available resources (see Table 7.2). The remaining logic resources are reserved for further processing and analysis of the recovered time-stretched data.

Table 7.2: Slice Logic Utilization

Slice Logic Utilization	Used	Available	% Utilization
Number of Slice Registers	20,750	301,440	6%
Number of Slice LUTs	25,478	150,720	16%
Number of RAMB18E1/FIFO18E1s	8	832	1%

## 7.5 Future Work

Future work must circumvent some of the remaining restrictions in throughput. In particular, we need to improve the divider core so as to match the incoming data throughput from the ADC. If we find that fixed point division results in sufficiently accurate data recovery, then the SPFP converter and divider can be bypassed, significantly reducing logic

resources and allowing for increased throughput. A faster interface needs to be utilized to improve transfer speeds to the PC. Gigabit ethernet would be the optimal interface, but a controller core must be implemented on the FPGA before it can be used. We are also looking to include a PCI-e interface on future digitizer board designs, to further boost transfer speeds to the PC.

Additionally, further signal processing can be implemented directly on the FPGA, instead of on the PC. For instance, it may be possible to generate eye-diagrams and perform signal integrity analysis in hardware, without using RAM or software. Looking further ahead, more advanced signal processing techniques, such as interpolation, will aid in reducing synchronization jitter and improving the resolution of recovered data.

## 7.6 Conclusion

We have demonstrated here, for the first time, a truly real-time TiSER prototype, which uses a high-performance, custom designed digitizer board to perform both digitization and processing on the same physical platform. Bypassing the slow, intermediate transfer step eliminates the previous throughput bottlenecks, allowing for continuous capture and analysis of time-stretched data. The work presented here sets us on the path to transforming TiSER from a laboratory demonstration to a valuable real-world tool.



## CHAPTER 8

# Sub-millisecond Fluorescence Microscopy using Beat-frequency Multiplexed Excitation

Fluorescence imaging is the most widely used method for unveiling the molecular composition of biological specimens. However, the weak optical emission of fluorescent probes and the tradeoff between imaging speed and sensitivity[49] is problematic for acquiring blur-free images of fast phenomena, such as sub-millisecond biochemical dynamics in live cells and tissues[50], and cells flowing at high speed[51]. In this chapter I report a solution that achieves real-time pixel readout rates one order of magnitude faster than a modern electron multiplier charge coupled device (EMCCD) the gold standard in high-speed fluorescence imaging technology[2]. Deemed fluorescence imaging using radiofrequency-tagged emission (FIRE), this approach maps the image into the radiofrequency spectrum using the beating of digitally synthesized optical fields [106]. We demonstrate diffraction-limited confocal fluorescence imaging of stationary cells at a frame rate of 4.4 kHz, and fluorescence microscopy in flow at a velocity of 1 m/s, corresponding to a throughput of approximately 50,000 cells per second.

### 8.1 Introduction

The spatial resolution of modern fluorescence microscopy has been improved to a point such that sub-diffraction limited resolution is routinely possible[52]. However, the demand for continuous, sub-millisecond time resolution using fluorescence microscopy remains largely unsatisfied. Such a real-time fluorescence microscope would enable resolution of dynamic biochemical phenomena such as calcium and metabolic waves in live cells [17, 18], action

potential sequences in large groups of neurons [19, 20, 21], or calcium release correlations and signaling in cardiac tissue [22]. High-speed microscopy is also invaluable for imaging biological cells in flow. Flow imaging can quickly perform high-throughput morphology [51], translocation [55], and cell signaling [56] analysis on large populations of cells. However, as fluorescence imaging frame rates increase towards the kHz range, the small number of photoelectrons generated during each exposure drops below the noise floor of conventional image sensors, such as the charge coupled device (CCD).

The desire to perform high-speed, low-photon number imaging has been the primary driving force behind the development of the EMCCD camera. EMCCDs use on-chip electronic gain to circumvent the high-speed imaging signal-to-noise ratio (SNR) problem. However, while EMCCDs can exhibit 1000-fold gain, the serial pixel readout strategy limits the full frame ( $512 \times 512$  pixels) rate to less than 100 Hz. A photomultiplier tube (PMT) can provide 1000 $\times$  higher gain, 10 $\times$  lower dark noise, and 50 $\times$  higher bandwidth than EMCCDs, but they are not typically manufactured in large array format. This limits the utility of PMTs in fluorescence microscopy to point-scanning applications, in which the speed of serial beam scanning limits the overall frame rate [57].

Due to their parallel readout architecture, scientific complementary metal-oxide-semiconductor (sCMOS) cameras exhibit low readout noise and pixel readout rates up to 50 $\times$  higher than EMCCDs, including line scan readout rates of  $\sim 100$  kHz. However, the internal gain of EMCCDs ultimately makes them more attractive than sCMOS for the lowest light fluorescence imaging applications [2]. While both technologies are widely used in high-speed fluorescence microscopy, neither possesses a sufficient line readout rate to perform blur-free imaging of cells at the meter per second flow velocities typical of flow cytometry.

Here, we present FIRE microscopy, a high-speed radiofrequency (RF) communications approach to fluorescence microscopy, which combines the benefits of PMT sensitivity and speed with frequency-domain signal multiplexing, RF spectrum digital synthesis, and digital lock-in amplification to enable fluorescence imaging at kHz frame rates. FIRE uses RF multiplexing techniques from the field of communication to address the speed limitations of fluorescence imaging, much in the same spirit as stretch-time encoded amplified microscopy

(STEAM)[107] employs time- and wavelength-division multiplexing to enable high speed brightfield imaging.

The central, defining feature of FIRE is its ability to excite fluorescence in each individual point of the sample at a distinct radiofrequency. Digitally synthesized radiofrequency tagging of pixels fluorescence emission occurs at the beat frequency between two interfering frequency-shifted laser beams. Similar to frequency-domain multiplexing in wireless communication systems, each pixel in a row of a FIRE image is assigned its own RF frequency. In a two-dimensional FIRE image, pixels are analogous to points on a time-frequency Gabor lattice. A single-element photodetector simultaneously detects fluorescence from multiple pixels, and an image is reconstructed from the frequency components of the detector output, which are resolved using parallel lock-in amplification in the digital domain. A diagram of the experimental implementation of the FIRE microscope is shown in Figure 8.1. A detailed description is included in the Methods section.

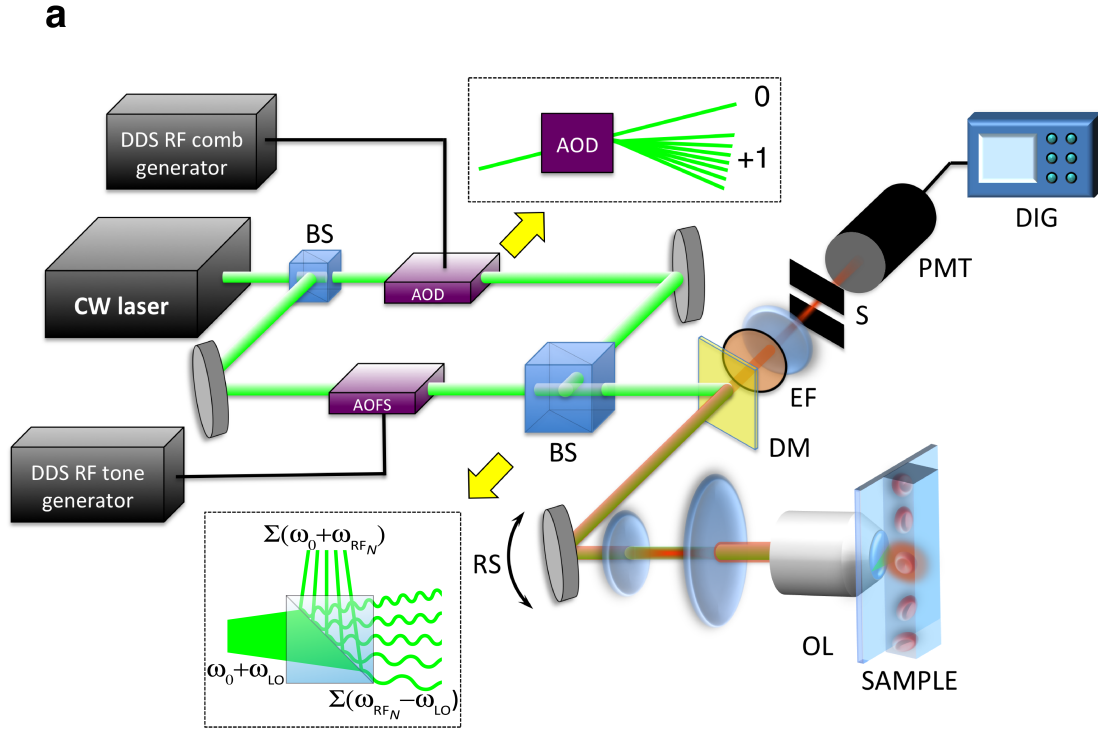

Figure 8.1: Schematic diagram of the FIRE microscope. BS: beamsplitter AOD: acousto-optic deflector AOFS: acousto-optic frequency shifter DM: dichroic mirror EF: fluorescence emission filter OL: objective lens PMT: photomultiplier tube DIG: 250 MS/s digital recording oscilloscope RS: resonant scanning mirror. Upper inset: the AOD produces a single diffracted 1st order beam for each RF comb frequency. Lower inset: beat frequency generation at the Mach-Zehnder interferometer (MZI) output. Not shown: A cylindrical lens is placed after the AOFS to match the divergence of the local oscillator (LO) beam to that of the RF beams.

FIRE performs beat frequency excitation multiplexing by employing acousto-optic devices in a Mach-Zehnder interferometer (MZI) configuration. As shown in Fig. 8.1, the light in one arm of the MZI is frequency shifted by a 100-MHz bandwidth acousto-optic deflector, driven by a comb of RF frequencies, phase-engineered [108] to minimize its peak-to-average power ratio. The AOD produces multiple deflected optical beams possessing a range of both output angles and frequency shifts [109]. Light in the second arm of the interferometer passes through an acousto-optic frequency shifter, driven by a single RF

tone, which provides a local oscillator (LO) beam. A cylindrical lens is used to match the LO beams angular divergence to that of the RF comb beams. At the MZI output, the two beams are combined and focused to a horizontal line on the sample, mapping frequency shift to space. Since fluorescent molecules in the sample function as square-law detectors of the total optical field, fluorescence is excited at the various beats defined by the difference frequencies of the two arms of the interferometer. Fluorescence emission from the sample is detected by a PMT in a confocal configuration, using a slit aperture to reject out-of-plane fluorescence emission. A resonant scan mirror performs high-speed scanning in the transverse direction for two-dimensional imaging. Given the finite frequency response of fluorophores, the LO beam frequency shift is chosen to heterodyne the beat frequency excitation spectrum to baseband, in order to maximize the useable modulation bandwidth. This is necessary because AODs typically operate over an upshifted, sub-octave passband to avoid harmonic interference [109]. Direct digital synthesis (DDS) of the RF comb used to drive the AOD defines each pixels excitation by a specific radiofrequency and phase, resulting in phase coherence between the RF comb and the detected signal [110]. This phase coherence enables image de-multiplexing using a parallel array of phase-sensitive digital lock-in amplifiers, implemented in Matlab. FIREs parallel readout results in a maximum pixel rate equal to the bandwidth of the AOD.

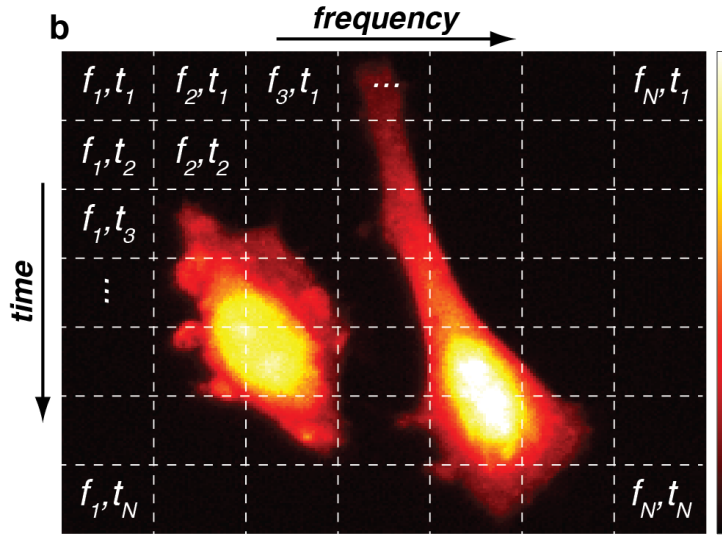

Figure 8.2: Gabor lattice diagram of FIREs frequency-domain multiplexing approach. Points in the horizontal direction are excited in parallel at distinct radiofrequencies. Scanning this line scan excitation in the vertical direction using a galvanometer generates a two-dimensional image.

Figure 8.3 shows the typical output of the FIRE microscope. The detected time-domain signal (Fig. 8.3A) is a Fourier superposition of the RF-tagged emission from a row of pixels. The time-resolved frequency spectrum, calculated using a short time Fourier transform, (Fig. 8.3B) reveals the different frequency components associated with the positions of the sample within the row. The vertical locations of the sample are recovered from the reference output of the 2.2-kHz resonant scan mirror, and the final image is formed (Fig. 8.3C).

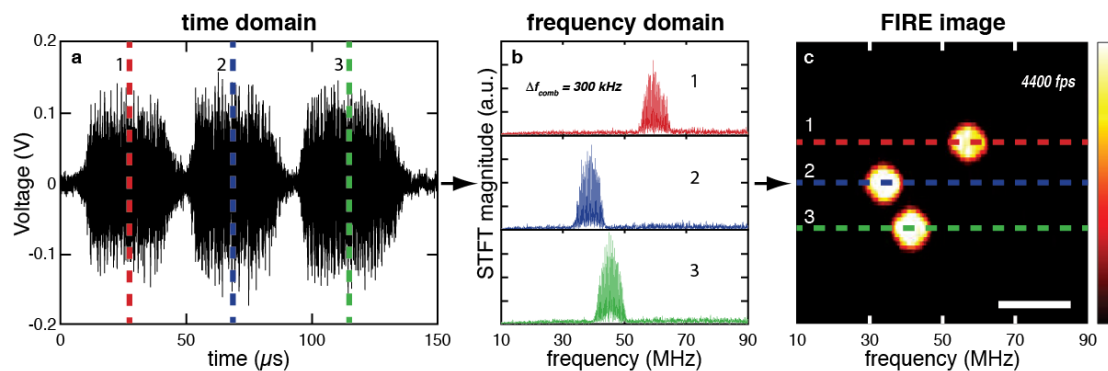
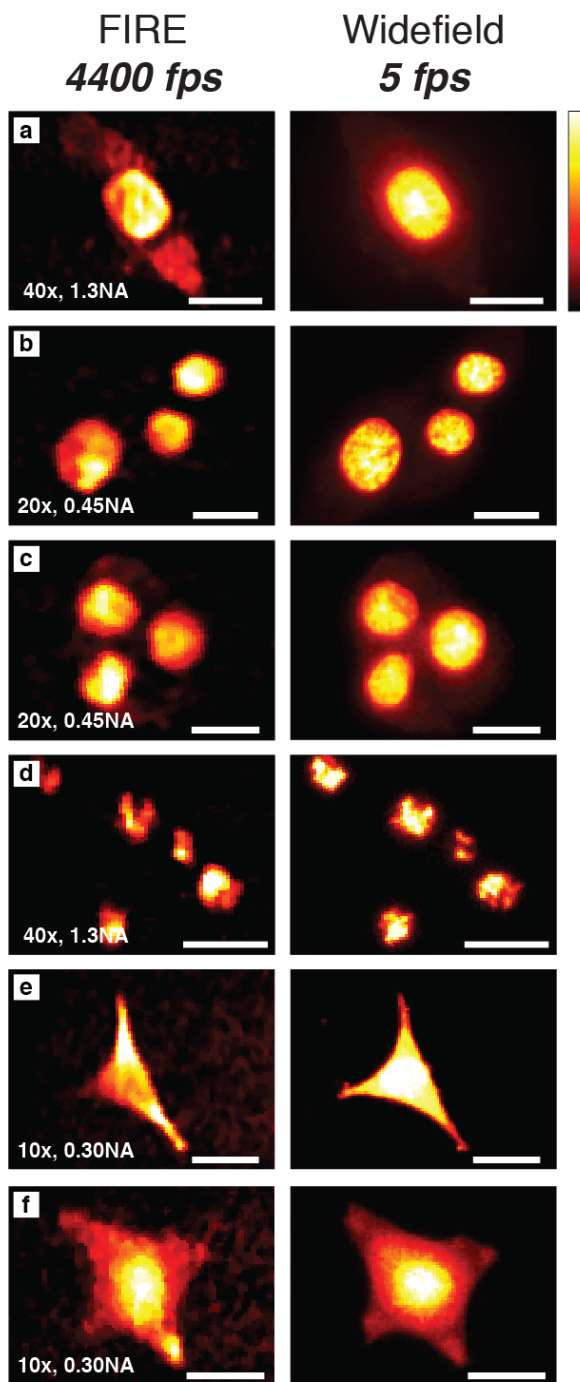

Figure 8.3: Illustration of the radiofrequency tagging of fluorescent emission in FIRE. (A) Time domain data output from the PMT. (B) Short-time Fourier transforms of the signal in (A), indicating the bead horizontal positions. (C)  $256 \times 256$  pixel image of three immobilized fluorescent beads recorded using 256 excitation frequencies. The sample was imaged at a 4.4-kHz frame rate. The vertical axis in the image is oversampled to yield 256 pixels. Scale bar =  $30 \mu\text{m}$ .

To demonstrate FIRE microscopy on biological samples, we imaged adherent cells stained with various fluorophores at a frame rate of 4.4 kHz. NIH 3T3 mouse embryonic fibroblasts, C6 astrocyte rat glial fibroblasts, and *S. cerevisiae* yeast were stained with a fluorescent cytosol stain (Calcein AM) or nucleic acid stain (Syto16). Figure 8.4 shows image crops of cells, taken with both the FIRE microscope and a conventional widefield fluorescence microscope based on a  $1280 \times 1024$  pixel CMOS camera. The frame rate difference of nearly 3 orders of magnitude is mitigated by the gain of the PMT detector combined with digital lock-in amplifier image de-modulation. To further demonstrate the ability of two-dimensional FIRE to record fluorescent dynamic phenomena, we imaged fluorescent beads flowing at a velocity of  $2.3 \text{ mm/s}$  inside a microfluidic channel.

Flow cytometry is another application of high-speed fluorescence measurement. As compared to single-point flow cytometry, imaging flow cytometry provides a myriad of information that can be particularly useful for high-throughput rare cell detection [53]. The high flow velocities associated with flow cytometry demand fast imaging shutter speeds and high sensitivity photodetection to generate high SNR, blur-free images. Commercial



8.4: Comparison of FIRE microscopy with widefield fluorescence imaging. 488nm laser excitation was used for FIRE imaging ( $8.5\mu W$  per pixel, measured before the objective), and mercury lamp excitation was used for widefield imaging. All FIRE images use an RF comb frequency spacing of 400 kHz, and are composed of  $200 \times 92$  pixels. Slight vignetting is observed in the FIRE images due to the mismatch of the Gaussian profile of the LO beam with the flat-top RF comb beam. This mismatch and the resulting vignetting can be eliminated using digital pre-equalization of the RF comb in the direct digital synthesis (DDS) generator. The particular objective lens used is denoted in each FIRE image. (A-C) C6 astrocytes stained with Syto16. Scale bars =  $10\mu m$ . (D) *S. cerevisiae* yeast stained with Calcein AM. Scale bars =  $5\mu m$ . (E,F) NIH 3T3 cells stained with Calcein AM. Scale bars =  $20\mu m$ .



imaging flow cytometers available from Amnis Corporation use time delay and integration CCD technology in order circumvent this issue, but the serial pixel readout strategy of this technology currently limits the device to a throughput of approximately 5,000 cells per second [111]. To overcome the Poisson statistics inherent to detecting rare circulating tumor cells in milliliter samples of blood higher throughput is needed [112, 113].

To demonstrate high-speed imaging flow cytometry using FIRE, we used a single stationary line scan of 125 pixels spaced by 800 kHz (pixel readout rate of 100 MHz, line scan rate of 800 kHz), and imaged Syto16-stained MCF-7 human breast carcinoma cells flowing in a microfluidic channel at a velocity of 1 m/s. Assuming a cell diameter of 20  $\mu m$ , this velocity corresponds to a throughput of 50,000 cells per second. For comparison, we also imaged Syto16-stained MCF-7 cells in flow at the same velocity using a frame transfer EMCCD in single exposure mode ( $512 \times 512$  pixels). As shown in Figure 8.5, while the high sensitivity and gain of the EMCCD yields a reasonable SNR image, the cameras minimum exposure time of 10  $\mu s$  and its frame transfer nature creates significant blur at these flow velocities. In contrast, the FIRE line scan shutter speed of 1.25  $\mu s$  yields blur-free images with comparable SNR.

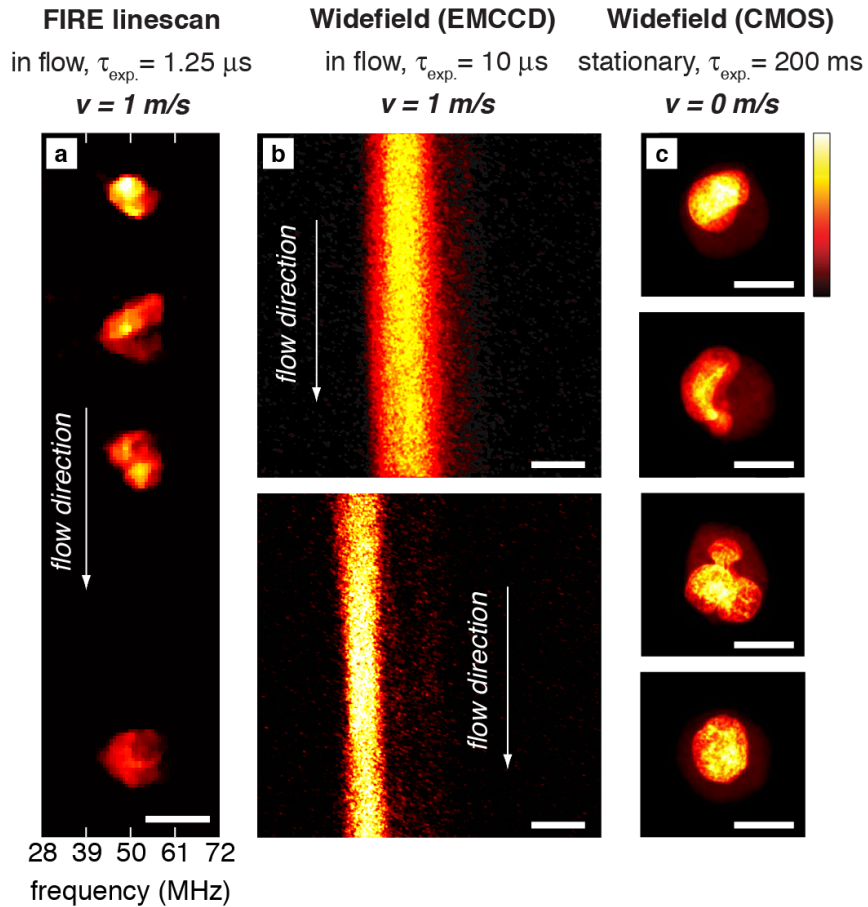

Figure 8.5: High-speed imaging flow cytometry. All images are of MCF-7 breast carcinoma cells, stained with Syto16, taken using a 60x, 0.70-NA objective lens. (A) Representative FIRE images of cells flowing at a velocity of 1 m/s, taken using a pixel frequency spacing of 800 kHz, and  $54 \mu\text{W}$  of 488-nm laser power per pixel, measured before the objective. (B) Single  $10\text{-}\mu\text{s}$  exposure frame transfer EMCCD images of individual cells flowing at a velocity of 1 m/s. The electron multiplier gain was adjusted to produce maximal image SNR, and the EMCCD vertical shift time was set to 564 ns. Blur is observed in the image due to the long exposure time and the frame transfer nature of the EMCCD. (C) Representative widefield fluorescence images of stationary MCF-7 cells. All scale bars are  $10 \mu\text{m}$ .

Other approaches to frequency-domain fluorescence imaging have been reported previously [114, 115, 116, 117]. However, the kHz-bandwidth, mechanical modulation schemes used in these works do not provide sufficient pixel readout rates required for sub-millisecond

imaging. This implementation of FIRE features pixel readout rates in the 100 MHz range, but this rate can be directly extended to more than 1 GHz through the use of wider bandwidth AODs [109]. FIREs maximum modulation frequency, and thus maximum pixel readout rate, is intrinsically limited by the samples fluorescence lifetime. If the excitation frequency is less than  $1/\tau_l$ , where  $\tau_l$  is the fluorescence lifetime of the sample, the emitted fluorescence will oscillate at the excitation frequency with appreciable modulation [49]. Further, beat-frequency modulation is critical to the speed of FIRE; the beating of two coherent, frequency-shifted optical waves produces a single RF tone, without any harmonics that can introduce pixel crosstalk and reduce the useable bandwidth.

The flexibility afforded by digitally synthesizing the amplitude and phase of the RF spectrum provides complete, real-time control over the number of pixels, pixel frequency spacing, pixel non-uniformity, and field of view. Since PMTs inherently possess smaller dynamic range than CCD or CMOS technologies, maximizing this quantity per pixel is critical to the performance of FIRE. Specifically, phase-engineering the excitation frequency comb enables the dynamic range of each pixel to scale as  $D/\sqrt{M}$ , where  $D$  is the dynamic range of the PMT, and  $M$  is the pixel-multiplexing factor [118]. This is in contrast to the case where all excitation frequencies initial phases are locked, which yields images with a dynamic range of  $D/M$ . While FIRE fundamentally presents a tradeoff in dynamic range for speed, it improves in sensitivity when compared to single point scanning fluorescence microscopy, as multiplexing the sample excitation by a factor of  $M$  yields an  $M$ -fold increase in the dwell time of each pixel. However due to the parallel nature of detection, FIRE shares shot noise across all pixels in a row. This causes the shot-noise limited uncertainty at each pixel to scale with the square root of the total number of photons collected from all pixels in a line scan. The extent to which this effect degrades the SNR at each pixel depends inversely on the sparsity of the sample.

Beat frequency multiplexing is also applicable to other types of laser scanning microscopy, including two-photon excited fluorescence microscopy. Perhaps most notably, because emission from each pixel is tagged with a distinct radiofrequency, FIRE is inherently immune to pixel crosstalk arising from fluorescence emission scattering in the sample

the effect that typically limits the imaging depth in multifocal multiphoton microscopy [119]. In combination with fast fluorophores [120], FIRE microscopy may ultimately become the technique of choice for observation of nano- to microsecond-timescale phenomena using fluorescence microscopy.

## 8.2 Photodetection and digitization of fluorescence signals

Fluorescence emission is detected by a bialkali PMT (R3896, Hamamatsu) after passing through a dichroic mirror and a bandpass filter. The current signal from the PMT is amplified by a 400-MHz bandwidth current amplifier with 5 kV/A transimpedance gain. This voltage signal is digitized using a 250 MS/s, 8-bit resolution oscilloscope. For 2-D scanned images, the reference output from the resonant scan mirror is used for triggering, and is also digitized and saved for image reconstruction. For the flow cytometry experiments, the digitizer is triggered off of the image signal itself. The digitized data is then transferred to a PC for signal processing.

## 8.3 Digital Signal Processing

Direct digital synthesis of the LO and RF comb beams is accomplished using the two outputs of a 5 GS/s arbitrary waveform generator, which are amplified to drive the AOD and AOFS. After photodetection and digitization, two digital de-multiplexing algorithms can be used to recover the fluorescence image from the frequency-multiplexed data. The first employs the short time Fourier transform (STFT) and is similar to the demodulation technique used in orthogonal frequency division multiplexing (OFDM) communication systems. The second technique uses an array of digital lock-in amplifiers to heterodyne and de-multiplex each comb-line separately. In this work we have exclusively employed the lock-in demodulation technique.

The STFT method works by segmenting the data sequence into frames, and performing a discrete Fourier transform (DFT) on each frame to recover the frequency-multiplexed

signal. Each frame corresponds to a 1D line-scan. Following standard procedures of OFDM demodulation, in order to avoid pixel-pixel cross talk from power spreading across frequency bins, the time duration of each frame is set as an integer multiple of the inverse of the frequency comb spacing. In this case, the frequency channels are said to be orthogonal, and the DFT bins lie precisely on the frequency comb lines. The maximum line rate in this scenario is equal to the frequency comb spacing. In the work presented here, this corresponds to 300 kHz, 400 kHz, and 800 kHz line rates (Figures 2, 3, and 4 respectively).

The lock-in amplifier demodulation technique is implemented by digitally mixing the data signal with copies of each frequency comb line. Mixing of the comb lines and the signal downshifts the corresponding comb line to baseband. A low pass filter (LPF) extinguishes all other comb lines, leaving only the modulated fluorescent signal from the comb line of interest. To obviate phase locking the reference to the signal, both in-phase (I) and quadrature phase (Q) mixing terms are calculated. The magnitude of the sum of I- and Q-channels are equal to the amplitude of the signal. The bandwidth of the LPF is less than half the comb spacing to prevent pixel crosstalk in frequency space. With the reduced analog bandwidth after filtering, each pixels signal can be boxcar-averaged and under-sampled to at least the Nyquist rate, equal to the frequency comb spacing. The under-sampled data rate corresponds to the line rate of the system.

Although both the DFT and lock-in technique can be used to de-multiplex the fluorescence image, the lock-in technique has certain advantages: (a) there is no orthogonality requirement, leaving more flexibility in comb line configuration, (b) the nominal line rate is determined by the under-sampling factor, allowing for line-rates above the minimum Nyquist rate, and (c) the reference and signal can be phase locked, either by a priori estimation of the signal phase or via deduction from the ratio of I and Q channels. Phase locked operation rejects out of phase noise, resulting in a 3-dB improvement in SNR.

## 8.4 Two-dimensional image scanning

In this implementation of FIRE, images are acquired on an inverted microscope, in a descanned configuration, using a 2.2 kHz resonant scan mirror. To avoid nonlinear space-to-time mapping from the resonant scanner in the vertical direction, an aperture is placed in the intermediate image plane of the imaging system to limit the sample excitation to the approximately linear portion of the scan field. A sine correction algorithm is further applied to the image in Matlab to compensate for any residual distortion in the image arising from the sinusoidal deflection pattern of the mirror. Processing of the raw computed images is performed in Matlab. Brightness and contrast adjustments, thresholding, and 2-dimensional low-pass filtering are performed on all images. The raw FIRE image from Figure 8.4(a) from the text is shown below in Figure 8.6, along with the images generated during the intermediate image processing steps.

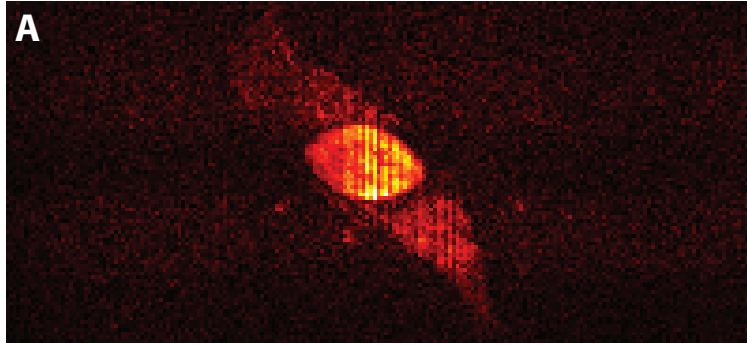

**Raw Image**

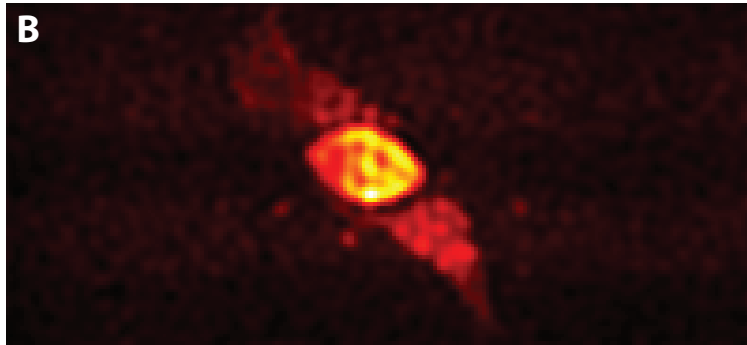

**2D Low Pass  
Butterworth Filter**

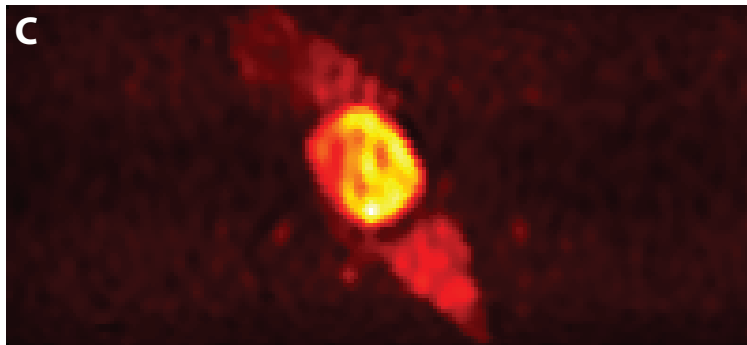

**Sine Correction +  
3 by 3 Median Filter**

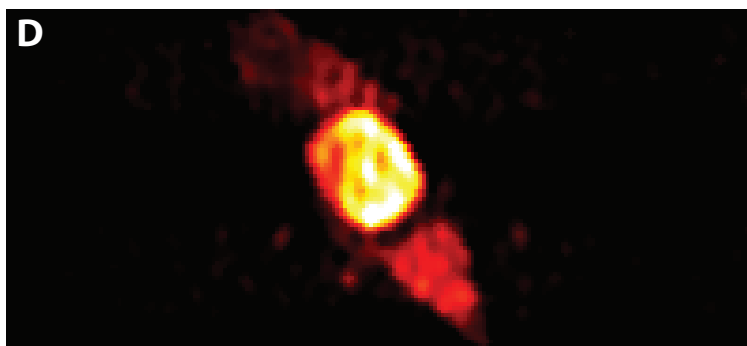

**Rescaling Intensity +  
Background Removal**

Figure 8.6: Intermediate image processing steps of FIRE images. After obtaining the raw image (A) from the FIRE system, the image is spatially filtered (B). A sine correction algorithm is applied (C), along with a median filter, to correct for artifacts introduced by the sine correction. Finally, the image is rescaled in intensity (D) to adjust the image saturation and remove any background.

## 8.5 Imaging Flow Cytometry

MCF-7 breast carcinoma cells were stained with Syto16, prior to fixation with formaldehyde. The cells were then suspended in phosphate-buffered saline, and flowed through a linear, rectangular cross-section  $110\mu m \times 60\mu m$  microfluidic channel made from polydimethylsiloxane, using a syringe pump, at a fixed volumetric rate. The fluid flow velocity is calculated using the equation

$$V = \frac{Q}{A}$$

where  $Q$  is the volumetric flow rate, and  $A$  is the cross-sectional area of the channel. Vertical scaling calibration of the images is performed after imaging  $10\mu m$  spherical beads flowing at the same volumetric flow rate.

## 8.6 FIRE design criteria - spatial resolution, number of pixels, and field of view

The FIRE microscope is a diffraction-limited technique. Like other laser scanning microscopy techniques, the minimum transverse spatial resolution is the diffraction limited spot size determined by the numerical aperture of the objective and the laser excitation wavelength.

The pixel rate of the system is equal to the product of the nominal line rate and the number of pixels per line. With the nominal line rate limited to the comb spacing, the maximum pixel rate of FIRE is equal to the bandwidth of the AOD,

$$B_{AOD} = p_x \times r_{line}$$

where  $p_x$  is the number of pixels in a line, and  $r_{line}$  is the line rate. We have chosen the x-axis as the AOD deflection direction.

The number of resolvable points per line is determined by the time-bandwidth product of the AOD. To satisfy the Nyquist spatial sampling criterion, the number of pixels per



line should be at least twice this value,

$$p_x = 2 \times \text{TBP}_{AOD}.$$

The field of view in the x-direction is the number of resolvable points times the diffraction limited spot-size,

$$\begin{aligned} \text{FOV}_x &= d \times \text{TBP}_{AOD} \\ &= \frac{d \times p_x}{2}. \end{aligned}$$

Nyquist oversampling in the y-direction must also be satisfied. In the case of 2-D imaging with a scan mirror, the frame-rate, field of view, and number of pixels in the y-direction should satisfy the following relations

$$\begin{aligned} p_y \times r_{frame} &= r_{line} \\ \text{FOV}_y &= \frac{d \times p_y}{2}. \end{aligned}$$

The range of the scan mirror should be chosen to match the  $\text{FOV}_y$  above.

The above criteria for oversampling in the y-direction are not unique to FIRE, and should be satisfied for any imaging system. However, satisfying the Nyquist criterion in the y-direction is particularly important for FIRE. Under-sampling in the y-direction can lead to a rate of change of fluorescence that is greater than half the line-rate. In the frequency domain, the generated sidebands will extend beyond half the comb-spacing, resulting in inter-pixel cross talk and blurring in the x-direction. With oversampling of each diffraction limited spot of a sample, this blurring effect can be avoided.

## 8.7 Shot noise-limited SNR analysis

Fluorescence imaging generates darkfield images of samples by estimating the number of emitted photons from each excited pixel of a sample. In conventional fluorescence imaging, the number of photons is estimated through integration of the optical signal. In FIRE, the

light emitted from each pixel is tagged at a particular radiofrequency, and we differentiate the strength of the signal coming from each pixel either by performing a short time Fourier transform, or demodulating the signal from each pixel using parallel digital lock-in amplification. As a result, FIRE reads out multiple pixels in parallel, increasing imaging speed and increasing the integration time for a given frame rate. However, mapping pixels into the frequency domain causes a unique shot noise cross talk, by which the uncertainty in determining the number of photons from a single pixel increases with the total number of photons collected in the line scan. We quantify this effect below. A full noise analysis would take into account PMT quantum efficiency, noise figure, and quantization of the analog-to-digital converter. The analysis below is simplified to only include photon shot noise, which is the dominant noise source in FIRE.

We can consider the total number of photons detected from a line of  $M$  pixels in a short time  $dt$  to be an infinitesimal Poissonian random variable  $dN(t)$ , with mean and variance given by

$$\langle N(t) \rangle = \text{var} \{dN(t)\} = \sum_{m=1}^M \bar{N} (1 + \sin \omega_m t) \frac{dt}{T}$$

Each  $\omega_m$  is the modulation frequency of the light emitted from pixel  $m$ . Together all the frequencies constitute an orthogonal set over the period  $T$ , i.e.

$$\int_0^T \sin(\omega_k t) \sin(\omega_m t) \frac{dt}{T} = \frac{1}{2} \delta_{k,m}.$$

The period  $T$  is the time for one line scan.  $\bar{N}_m$  is the mean number of photons detected from the pixel  $m$  over one line scan, with

$$\sum_{m=1}^M \bar{N}_m = \bar{N}_{tot}.$$

In FIRE, to measure the signal detected from each pixel, we estimate the average power at each comb line of the detected optical signal:

$$\langle X_k \rangle = \int_0^T \sin(\omega_k t) \langle dN(t) \rangle$$

where the random variable  $X_k$  is the measured signal strength of pixel  $k$ , a summation of infinitesimal Poisson random variables. We assume all  $dN(t)$  to be independent, equivalent to the white noise approximation.

To analyze the SNR of the measurement, we calculate the mean and the variance of  $X_k$ :

$$\begin{aligned}
\langle X_k \rangle &= \int_0^T \sin(\omega_k t) \langle dN(t) \rangle \\
&= \int_0^T \sin(\omega_k t) \sum_{m=1}^M \bar{N}_m (1 + \sin \omega_m t) \frac{dt}{T} \\
&= \sum_{m=1}^M \frac{\bar{N}_m}{2} \delta_{k,m} = \frac{\bar{N}_k}{2}
\end{aligned}$$

$$\begin{aligned}
\text{var} \{X_k\} &= \int_0^T \text{var} \{ \sin(\omega_k t) dN(t) \} \\
&= \int_0^T \sin^2(\omega_k t) \sum_{m=1}^M \bar{N}_m (1 + \sin \omega_m t) \frac{dt}{T} \\
&= \sum_{m=1}^M \frac{\bar{N}_m}{2} = \frac{\bar{N}_{tot}}{2}
\end{aligned}$$

The shot noise measured from a particular pixel depends on how many photons are measured at all the other pixels in the line. This is a form of cross talk. A set of bright pixels in a line scan will lead to more uncertainty in the measurement of all the other pixels, no matter their brightness. The SNR of FIRE improves for bright pixels in a sparsely fluorescent sample, and degrades for dim pixels in a bright sample.

The shot noise limited SNR at the  $k$ th pixel is given by (See Figure 8.7):

$$\text{SNR} = \frac{\langle X_k \rangle}{\sqrt{\text{var} \{X_k\}}} = \frac{1}{\sqrt{2}} \frac{\bar{N}_k}{\sqrt{\bar{N}_{tot}}}. \quad (8.1)$$

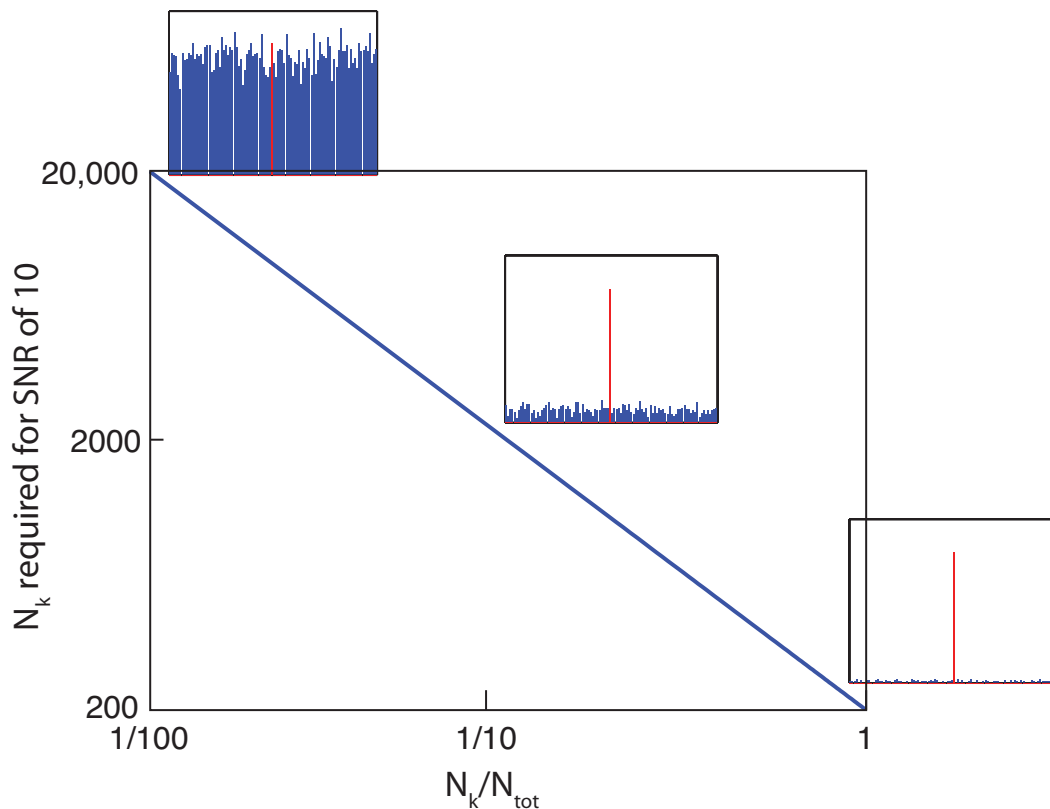

Figure 8.7: The SNR at a particular pixel is dependent on the number of photons incident at that pixel as well as the total number of photons incident at all the other pixels in a line. In this figure, we plot the required number of photons detected at some pixel  $k$  to achieve a shot noise limited SNR of 10, vs. the ratio of the number of photons incident on pixel  $k$  to the total number of photons incident on a line (c.f. Equation 8.1). As illustrated, the required number of photons detected at pixel  $k$  for an SNR of 10 decreases as the signal at pixel  $k$  increasingly dominates the total signal detected. For sparse samples, the sensitivity of FIRE improves. The insets illustrate examples of a linescan with the corresponding  $N_k/N_{tot}$  ratio.

Although the cross talk reduces the sensitivity of FIRE for samples of high average brightness, it is important to note that the mean number of photons from pixel  $k$  accumulated over the period  $T$  is larger by a factor of  $M$  than it would be for a single point laser scanner. This is because all pixels in a line are collected in parallel, increasing the

integration time by a factor  $M$  for the same line scan time. In a single point laser scanning system, the mean number of photons detected in one line scan of period  $T$  would be reduced to  $\bar{N}_k/M$ . The shot noise limited SNR in that case would be:

$$\frac{\langle X_k \rangle}{\sqrt{\text{var} \{X_k\}}} = \frac{\bar{N}_k/M}{\sqrt{\bar{N}_k/M}} = \frac{\bar{N}_k}{\sqrt{M\bar{N}_k}}.$$

Comparing the two SNR expressions, we see that for pixels with  $\bar{N}_k > 2\bar{N}_{tot}/M$ , FIRE will result in a SNR superior to single point laser scanning. This situation is generally satisfied for sparsely fluorescent samples.

In conclusion, although the frequency domain approach of FIRE results in shot noise cross talk, the increased integration time overcomes this reduction in sensitivity for sparse fluorescence samples by increasing the total number of photons collected as compared to single point laser scanners operating at the same line rate.

## 8.8 Optical sectioning capability

To measure the axial resolution of FIRE, we scanned a 500 nm fluorescent bead through the microscope focus using 1  $\mu m$  steps. This configuration used a 100 $\times$ , 1.4-NA objective and a 100  $\mu m$  height slit placed before the detector. The FWHM of the resulting curve is 5.9  $\mu m$ , as shown in Figure 8.8. This axial resolution could be further improved through the use of a smaller slit, as the 100  $\mu m$  slit is larger than the Airy disk at this magnification.

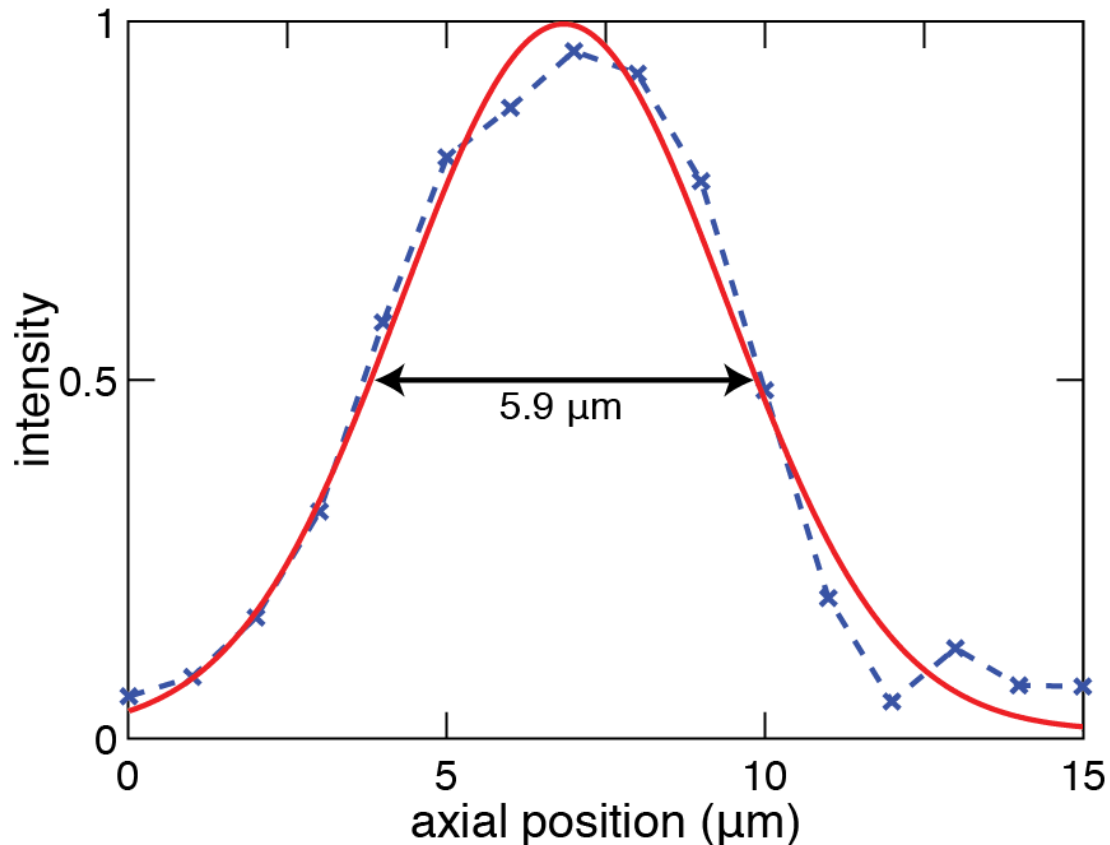

Figure 8.8: Measured axial resolution of FIRE. A Gaussian fit to the data shows a  $5.9 \mu\text{m}$  FWHM. The measurement is based on exciting a  $500 \text{ nm}$  fluorescent bead with  $488\text{-nm}$  excitation, and scanning the sample through the focus at  $1 \mu\text{m}$  intervals, using  $488\text{-nm}$  excitation. A  $100\times$ ,  $1.4\text{-NA}$  oil immersion objective was used in combination with a  $200\text{-mm}$  focal length tube lens and a  $100\text{-}\mu\text{m}$  tall slit aperture placed before the PMT.

## 8.9 Cell culture, Cell staining, and Microfluidic channel fabrication

NIH3T3 and MCF-7 cells and C6 astrocytes were propagated in Dulbecco's Modified Eagle Medium with 10% fetal bovine serum and 1% penicillin streptomycin at  $37^\circ\text{C}$  and 5%  $\text{CO}_2$ . Liquid cultures of *Saccharomyces cerevisiae* were grown in tryptic soy broth at 240 rpm and  $37^\circ\text{C}$ .

Prior to staining, cultured mammalian cells were released from culture flasks, seeded on glass slides, and allowed to spread for 24 hours. Mammalian cells were stained with either 4  $\mu\text{M}$  Syto16 green fluorescent nucleic acid stain in phosphate buffered saline (PBS) for 30 minutes, 1  $\mu\text{M}$  Calcein Red-Orange AM in culture media for 45 minutes, or 1 M Calcein AM in culture media for 45 minutes. Cells were washed twice with PBS then fixed for 10 minutes with 4% paraformaldehyde in PBS. Following fixation, cells were washed twice with PBS and prepared for either stationary or flow-through microfluidic imaging. For stationary imaging, number 1.5 cover glasses were placed on slides and sealed. In an effort to preserve the shape of adhered mammalian cells for flow-through microfluidic experiments a cell scraper was used to remove spread, stained, and fixed cells from glass slides. The cells were diluted in PBS.

*S. cerevisiae* were stained in suspension using the same concentration of Calcein AM for 45 minutes, washed twice with PBS, fixed with 4% paraformaldehyde in PBS, and washed twice with PBS. For stationary imaging the cells were seeded on glass slides and sealed under number 1.5 coverslips.

Microfluidic channels were fabricated using standard photolithographic and replica molding methods. Briefly, a mold was fabricated out of KMPR 1025 (MicroChem Corp., Newton, MA) on a silicon wafer using photolithography. Silicone elastomer (Sylgard 184, Dow Corning, Corp., Midland, MI) was cast and cured on the mold according to technical specifications. The cured elastomer was peeled off the mold. Vias for tubing interfaces were bored in the elastomer replica. A glass slide and the molded side of the elastomer replica were activated with air plasma, brought into contact, and baked at 65°C for 3 hours to bond the materials and form the microchannels. Tubing was inserted into the vias. For flow imaging, cell suspensions were introduced into the channel at a fixed volumetric rate using a syringe pump.

## CHAPTER 9

### Conclusion

In this thesis I have developed several new ultra-wide bandwidth techniques to enable the real-time capture and digital signal processing of fast signals and rare events. In particular, I used broadband dispersive optics to slow down fast signals to speeds accessible to high-bit depth digitizers and signal processors. I also applied telecommunication multiplexing techniques to boost the speeds of confocal fluorescence microscopy.

I have developed techniques to improve the spectral efficiency, bandwidth, and resolution of photonic time-stretch using polarization multiplexing, all-optical modulation, and coherent dispersive Fourier transformation. To reduce the latency and improve the data handling capacity, I have designed and implemented a real-time digital signal processing electronic backend, achieving 1.5 Tb/s instantaneous processing throughput. Additionally, I presented results from experiments highlighting TiSER's impact in real-world applications.

For resolving the fastest biological phenomena, I have introduced a new fluorescence imaging modality, which leverages techniques from wireless communication to reach record pixel and frame rates. Termed Fluorescence Imaging using Radio-frequency tagged Emission (FIRE), this new imaging modality is capable of resolving never before seen dynamics in living cells - such as action potentials in neurons and metabolic waves in astrocytes - as well as performing high-content image assays of cells and particles in high-speed flow. In combination with fast fluorophores, FIRE microscopy may ultimately become the technique of choice for observation of nano- to microsecond-timescale phenomena using fluorescence microscopy.



## REFERENCES

- [1] R. H. Walden, Analog-to-digital converters and associated ic technologies, 2008 IEEE Compound Semiconductor Integrated Circuits Symposium (2008) 2 pp.–2 pp.Cited Reference Count: 0 10323621 2008 IEEE Compound Semiconductor Integrated Circuits Symposium 12-15 Oct. 2008 Monterey, CA, USA Ieee 978-1-4244-1939-5.
- [2] C. Coates, New scmos vs. current microscopy cameras, Andor white paper.
- [3] T. Richter, E. Palushani, C. Schmidt-Langhorst, M. Nolle, R. Ludwig, J. K. Fischer, C. Schubert, Single wavelength channel 10.2 tb/s tdm-data capacity using 16-qam and coherent detection, 2011 Conference on Optical Fiber Communication - OFC 2011 Collocated National Fiber Optic Engineers Conference OFC/NFOEC 2011 (2011) 3 pp.–3 pp.Cited Reference Count: 4 12050403 2011 Conference on Optical Fiber Communication - OFC 2011 Collocated National Fiber Optic Engineers Conference OFC/NFOEC 2011 6-10 March 2011 Los Angeles, CA, USA Ieee 978-1-4577-0213-6.
- [4] D. Qian, E. Ip, M.-F. Huang, M.-J. Li, A. Dogariu, S. Zhang, Y. Shao, Y.-K. Huang, Y. Zhang, X. Cheng, Y. Tian, P. N. Ji, A. Collier, Y. Geng, J. Laires, C. Montero, V. Moreno, X. Prieto, T. Wang, 1.05pb/s transmission with 109b/s/hz spectral efficiency using hybrid single- and few-mode cores, in: Frontiers in Optics, Optical Society of America, 2012.
- [5] Group, [ieee 802.3 400 gb/s ethernet study interim meeting material may 17, 2013 victoria, bc, canada](http://grouper.ieee.org/groups/802/3/400GSG/public/13_05/index.shtml) (2013).  
URL [http://grouper.ieee.org/groups/802/3/400GSG/public/13\\_05/index.shtml](http://grouper.ieee.org/groups/802/3/400GSG/public/13_05/index.shtml)
- [6] PCI-SIG, [Pci express 4.0 evolution to 16gt/s, twice the throughput of pci express 3.0 technology](http://www.pcisig.com/news_room/Press_Releases/November_29_2011_Press_Release/) (2011).  
URL [http://www.pcisig.com/news\\_room/Press\\_Releases/November\\_29\\_2011\\_Press\\_Release/](http://www.pcisig.com/news_room/Press_Releases/November_29_2011_Press_Release/)
- [7] Apple, [Thunderbolt device driver programming guide](http://developer.apple.com/library/mac/#documentation/HardwareDrivers/Conceptual/ThunderboltDevGuide/Introduction/Introduction.html#//apple_ref/doc/uid/TP40011138-CH1-SW1).  
URL [http://developer.apple.com/library/mac/#documentation/HardwareDrivers/Conceptual/ThunderboltDevGuide/Introduction/Introduction.html#//apple\\_ref/doc/uid/TP40011138-CH1-SW1](http://developer.apple.com/library/mac/#documentation/HardwareDrivers/Conceptual/ThunderboltDevGuide/Introduction/Introduction.html#//apple_ref/doc/uid/TP40011138-CH1-SW1)
- [8] R. Merritt, Serial ata doubles data rate to 6 gbit/s, EE Times.
- [9] Universal serial bus 3.0 specification, revision 1.0, Tech. rep. (2011).
- [10] P. J. Winzer, G. Raybon, H. Song, A. Adamiecki, S. Corteselli, A. H. Gnauck, D. A. Fishman, C. R. Doerr, S. Chandrasekhar, L. L. Buhl, T. J. Xia, G. Wellbrock, W. Lee, B. Basch, T. Kawanishi, K. Higuma, Y. Painchaud, 100-gb/s dqpsk transmission: From laboratory experiments to field trials, *Journal of Lightwave Technology* 26 (17-20) (2008) 3388–3402.

- [11] P. J. Winzer, R. J. Essiambre, Advanced optical modulation formats, *Proceedings of the Ieee* 94 (5) (2006) 952–985.
- [12] J. A. Wang, S. R. Nuccio, H. Huang, X. Wang, J. Y. Yang, A. E. Willner, Optical data exchange of 100-gbit/s dqpsk signals, *Optics Express* 18 (23) (2010) 23740–23745, 676TG Times Cited:5 Cited References Count:14.
- [13] L. E. Nelson, S. L. Woodward, S. Foo, X. Zhou, M. D. Feuer, D. Hanson, D. McGhan, H. Sun, M. Moyer, M. O. Sullivan, P. D. Magill, Performance of a 46-gbns dual-polarization qpsk transceiver with real-time coherent equalization over high pmf fiber, *Journal of Lightwave Technology* 27 (1-4) (2009) 158–167.
- [14] D. Adamy, Introduction to electronic warfare modeling and simulation, / David L. Adamy. Computer document. (Norwood, Mass. : Books24x7.com [generator]) Includes index. Title from title screen. Available also in a print ed. Mode of access: Internet via World Wide Web. Digitized and made available by: Books 24x7.com. Access is available to the Yale Community through use of a networked computer with a Yale IP address. Users are required to login with a Yale email address. New users must register their email address in order to receive a password. Online book Yale Internet Resource Online Resource (2003).
- [15] J. Murphy, Development of high performance analog-to-digital converters for defense applications, GaAs IC Symposium. IEEE Gallium Arsenide Integrated Circuit Symposium. 19th Annual Technical Digest 1997 (Cat. No.97CH36098) (1997) 83–8686.
- [16] M. Abrams, Dawn of the e-bomb - for the wired world, the allure and the danger of high-power microwave weapons are both very real, *Ieee Spectrum* 40 (11) (2003) 24–30, 741AZ Times Cited:20 Cited References Count:3.
- [17] R. Y. Tsien, Fluorescent indicators of ion concentrations, *Methods in Cell Biology* 30 (1989) 127–156, u8244 Times Cited:310 Cited References Count:130.
- [18] H. R. Petty, Spatiotemporal chemical dynamics in living cells: From information trafficking to cell physiology, *Biosystems* 83 (2-3) (2006) 217–224, 018VR Times Cited:14 Cited References Count:36.
- [19] A. Grinvald, L. Anglister, J. A. Freeman, R. Hildesheim, A. Manker, Real-time optical imaging of naturally evoked electrical-activity in intact frog brain, *Nature* 308 (5962) (1984) 848–850, sn801 Times Cited:113 Cited References Count:25.
- [20] A. Cheng, J. T. Goncalves, P. Golshani, K. Arisaka, C. Portera-Cailliau, Simultaneous two-photon calcium imaging at different depths with spatiotemporal multiplexing, *Nature Methods* 8 (2) (2011) 139–U58, 712GQ Times Cited:17 Cited References Count:29.
- [21] R. Yuste, W. Denk, Dendritic spines as basic functional units of neuronal integration, *Nature* 375 (6533) (1995) 682–684, re576 Times Cited:485 Cited References Count:31.

- [22] Y. Shiferaw, G. L. Aistrup, J. A. Wasserstrom, Intracellular  $ca-2$  waves, afterdepolarizations, and triggered arrhythmias, *Cardiovascular Research* 95 (3) (2012) 265–268, 977SU Times Cited:0 Cited References Count:26.
- [23] J. F. Ruan, T. Kato, C. L. Santini, T. Miyata, A. Kawamoto, W. J. Zhang, A. Bernadac, L. F. Wu, K. Namba, Architecture of a flagellar apparatus in the fast-swimming magnetotactic bacterium mo-1, *Proceedings of the National Academy of Sciences of the United States of America* 109 (50) (2012) 20643–20648, 058AF Times Cited:1 Cited References Count:10.
- [24] J. M. Skotheim, L. Mahadevan, Physical limits and design principles for plant and fungal movements, *Science* 308 (5726) (2005) 1308–1310.
- [25] J. P. Gleghorn, E. D. Pratt, D. Denning, H. Liu, N. H. Bander, S. T. Tagawa, D. M. Nanus, P. A. Giannakakou, B. J. Kirby, Capture of circulating tumor cells from whole blood of prostate cancer patients using geometrically enhanced differential immunocapture (gedi) and a prostate-specific antibody, *Lab on a Chip* 10 (1) (2010) 27–29, 530KH Times Cited:62 Cited References Count:16.
- [26] Y. Y. Ng, M. R. M. Baert, E. F. E. de Haas, K. Pike-Overzet, F. J. Staal, Isolation of Human and Mouse Hematopoietic Stem Cells, Vol. 506 of *Methods in Molecular Biology*, Humana Press Inc, 999 Riverview Dr, Ste 208, Totowa, Nj 07512-1165 USA, 2009, pp. 13–21.
- [27] J. E. Slansky, Antigen-specific t cells: Analyses of the needles in the haystack, *Plos Biology* 1 (3) (2003) 329–331, 772HC Times Cited:6 Cited References Count:18.
- [28] M. Choolani, A. P. Mahyuddin, S. Hahn, The promise of fetal cells in maternal blood, *Best Practice and Research Clinical Obstetrics and Gynaecology* 26 (5) (2012) 655–667, 009NG Times Cited:0 Cited References Count:124.
- [29] D. R. Solli, C. Ropers, P. Koonath, B. Jalali, Optical rogue waves, *Nature* 450 (7172) (2007) 1054–U7, 240HY Times Cited:310 Cited References Count:29.
- [30] R. Aaij, C. A. Beteta, A. Adametz, B. Adeva, M. Adinolfi, C. Adrover, A. Afolder, Z. Ajaltouni, J. Albrecht, F. Alessio, M. Alexander, S. Ali, G. Alkhazov, P. A. Cartelle, A. A. Alves, S. Amato, Y. Amhis, L. Anderlini, J. Anderson, R. Andreassen, R. B. Appleby, O. A. Gutierrez, F. Archilli, A. Artamonov, M. Artuso, E. Aslanides, G. Auriemma, S. Bachmann, J. J. Back, C. Baesso, W. Baldini, R. J. Barlow, C. Barschel, S. Barsuk, W. Barter, A. Bates, T. Bauer, A. Bay, J. Beddow, I. Bediaga, S. Belogurov, K. Belous, I. Belyaev, E. Ben-Haim, M. Benayoun, G. Bencivenni, S. Benson, J. Benton, A. Berezchnoy, R. Bernet, M. O. Bettler, M. van Beuzekom, A. Bien, S. Bifani, T. Bird, A. Bizzeti, P. M. Bjornstad, T. Blake, F. Blanc, C. Blanks, J. Blouw, S. Blusk, A. Bobrov, V. Bocci, A. Bondar, N. Bondar, W. Bonivento, S. Borghi, A. Borgia, T. J. V. Bowcock, E. Bowen, C. Bozzi, T. Brambach, J. van den Brand, J. Bressieux, D. Brett, M. Britsch, T. Britton, N. H. Brook, H. Brown, A. Buchler-Germann, I. Burducea, A. Bursche, J. Buytaert, S. Cadeddu,

- O. Callot, M. Calvi, M. C. Gomez, A. Camboni, P. Campana, A. Carbone, G. Carboni, R. Cardinale, A. Cardini, H. Carranza-Mejia, L. Carson, K. C. Akiba, G. Casse, M. Cattaneo, C. Cauet, et al., First evidence for the decay  $b \rightarrow s(0) \gamma \mu^+ \mu^-$ , *Physical Review Letters* 110 (2), 065QE Times Cited:24 Cited References Count:34.
- [31] W. Kester, Understanding sinad, enob, snr, thd, thd+n, and sfdr so you don't get lost in the noise floor, Tech. rep., ANALOG DEVICES (2009).
- [32] R. H. Walden, Analog-to-digital converter survey and analysis, *Ieee Journal on Selected Areas in Communications* 17 (4) (1999) 539–550.
- [33] N. Kurosawa, H. Kobayashi, K. Maruyama, H. Sugawara, K. Kobayashi, Explicit analysis of channel mismatch effects in time-interleaved adc systems, *Ieee Transactions on Circuits and Systems I-Fundamental Theory and Applications* 48 (3) (2001) 261–271.
- [34] A. S. Bhushan, F. Coppinger, B. Jalali, Time-stretched analogue-to-digital conversion, *Electronics Letters* 34 (11) (1998) 1081–1083.
- [35] B. Jalali, F. M. A. Coppinger, Data conversion using time manipulation (1998).
- [36] Y. Han, B. Jalali, Photonic time-stretched analog-to-digital converter: Fundamental concepts and practical considerations, *Journal of Lightwave Technology* 21 (12) (2003) 3085.
- [37] A. Fard, S. Gupta, B. Jalali, Photonic time-stretch digitizer and its extension to real-time spectroscopy and imaging, *Laser Photonics Rev.* 7 (2) (2013) 207–263.
- [38] S. Gupta, B. Jalali, Time-warp correction and calibration in photonic time-stretch analog-to-digital converter, *Optics letters* 33 (22) (2008) 2674–2676.
- [39] J. Chou, O. Boyraz, D. Solli, B. Jalali, Femtosecond real-time single-shot digitizer, *Applied Physics Letters* 91 (16).
- [40] S. Gupta, B. Jalali, Time stretch enhanced recording oscilloscope, *Applied Physics Letters* 94 (4), 401VY Times Cited:11 Cited References Count:17.
- [41] J. Mallari, W. Cailin, J. Dan, Y. Guomin, A. Barklund, E. Miller, P. O'Mathuna, R. Dinu, A. Motafakker-Fard, B. Jalali, 100 gbps eo polymer modulator product and its characterization using a real-time digitizer, 2010 Conference on Optical Fiber Communication - OFC 2010. Collocated National Fiber Optic Engineers Conference OFC/NFOEC 2010 (2010) 3 pp.–3 pp.Cited Reference Count: 13 11306643 2010 Conference on Optical Fiber Communication - OFC 2010. Collocated National Fiber Optic Engineers Conference OFC/NFOEC 2010 21-25 March 2010 San Diego, CA, USA Ieee 978-1-55752-884-1.
- [42] H. Schmuck, Comparison of optical millimeter-wave system concepts with regard to chromatic dispersion, *Electronics Letters* 31 (21) (1995) 1848–1849.

- [43] J. M. Fuster, D. Novak, A. Nirmalathas, J. Marti, Single-sideband modulation in photonic time-stretch analogue-to-digital conversion, *Electronics Letters* 37 (1) (2001) 67–68.
- [44] Y. Han, O. Boyraz, B. Jalali, Ultrawide-band photonic time-stretch a/d converter employing phase diversity, *Microwave Theory and Techniques, IEEE Transactions on* 53 (4) (2005) 1404–1408.
- [45] A. Fard, B. Buckley, B. Jalali, Spectral efficiency improvement in photonic time-stretch analog-to-digital converter via polarization multiplexing, *Ieee Photonics Technology Letters* 23 (14) (2011) 947–949.
- [46] A. M. Fard, B. Buckley, S. Zlatanovic, C. S. Bres, S. Radic, B. Jalali, All-optical time-stretch digitizer, *Applied Physics Letters* 101 (5).
- [47] A. Fard, J. Y. Yang, B. Buckley, J. Wang, M. R. Chitgarha, L. Zhang, A. E. Willner, B. Jalali, Time-stretch oscilloscope with dual-channel differential detection front end for monitoring of 100 gb/s return-to-zero differential quadrature phase-shift keying data, *Optics Letters* 36 (19) (2011) 3804–3806.
- [48] C. P. Lai, D. Brunina, B. W. Buckley, C. Ware, W. J. Zhang, A. S. Garg, B. Jalali, K. Bergman, First demonstration of a cross-layer enabled network node, *Journal of Lightwave Technology* 31 (9) (2013) 1512–1525, iSI Document Delivery No.: 118DD Times Cited: 0 Cited Reference Count: 31 Lai, Caroline P. Brunina, Daniel Buckley, Brandon W. Ware, Cedric Zhang, Wenjia Garg, Ajay S. Jalali, Bahram Bergman, Keren NSF Engineering Research Center on Integrated Access Networks (CIAN) [EEC-0812072]; NSF Future Internet Design (FIND) program [CNS-837995] This work was supported in part by the NSF Engineering Research Center on Integrated Access Networks (CIAN) under Grant EEC-0812072, and in part by the NSF Future Internet Design (FIND) program under Grant CNS-837995. Ieee-inst electrical electronics engineers inc Piscataway.
- [49] J. R. Lakowicz, *Principles of fluorescence spectroscopy*, 3rd Edition, Springer, New York, NY, 2006.
- [50] M. Scanziani, M. Hausser, Electrophysiology in the age of light, *Nature* 461 (7266) (2009) 930–939, 506ZF Times Cited:44 Cited References Count:100.
- [51] G. S. Elliott, Moving pictures: Imaging flow cytometry for drug development, *Combinatorial Chemistry and High Throughput Screening* 12 (9) (2009) 849–859, 513SK Times Cited:5 Cited References Count:37.
- [52] B. Huang, M. Bates, X. W. Zhuang, Super-resolution fluorescence microscopy, *Annual Review of Biochemistry* 78 (2009) 993–1016, 471OZ Times Cited:226 Cited References Count:95 Annual Review of Biochemistry.
- [53] K. Goda, A. Ayazi, D. R. Gossett, J. Sadasivam, C. K. Lonappan, E. Sollier, A. M. Fard, S. C. Hur, J. Adam, C. Murray, C. Wang, N. Brackbill, D. Di Carlo, B. Jalali,

- High-throughput single-microparticle imaging flow analyzer, *Proceedings of the National Academy of Sciences of the United States of America* 109 (29) (2012) 11630–11635, 979RI Times Cited:0 Cited References Count:45.
- [54] J. M. Peters, M. Q. Ansari, Multiparameter flow cytometry in the diagnosis and management of acute leukemia, *Archives of Pathology and Laboratory Medicine* 135 (1) (2011) 44–54, 718HU Times Cited:7 Cited References Count:42.
- [55] T. C. George, S. L. Fanning, P. Fitzgerald-Bocarsly, R. B. Medeiros, S. Highfill, Y. Shimizu, B. E. Hall, K. Frost, D. Basiji, W. E. Ortyn, P. J. Morrissey, D. H. Lynch, Quantitative measurement of nuclear translocation events using similarity analysis of multispectral cellular images obtained in flow, *Journal of Immunological Methods* 311 (1-2) (2006) 117–129, 042KQ Times Cited:79 Cited References Count:19.
- [56] A. M. Khalil, J. C. Cambier, M. J. Shlomchik, B cell receptor signal transduction in the gc is short-circuited by high phosphatase activity, *Science* 336 (6085) (2012) 1178–1181, 950KK Times Cited:1 Cited References Count:27.
- [57] J. Pawley, *Handbook of Biological Confocal Microscopy*, 3rd Edition, Springer, New York, 2006.
- [58] J. D. Jackson, *Classical electrodynamics*, 3rd Edition, Wiley, New York, 1999, Ch. 7, pp. xxi, 800 p., 97046873 John David Jackson. ill. ; 27 cm. Includes index.
- [59] E. D. Diebold, N. K. Hon, Z. W. Tan, J. Chou, T. Sienicki, C. Wang, B. Jalali, Giant tunable optical dispersion using chromo-modal excitation of a multimode waveguide, *Optics Express* 19 (24) (2011) 23809–23817, 865PE Times Cited:4 Cited References Count:37.
- [60] P. Kelkar, F. Coppinger, A. Bhushan, B. Jalali, Time-domain optical sensing, *Electronics Letters* 35 (19) (1999) 1661–1662.
- [61] K. Goda, D. R. Solli, K. K. Tsia, B. Jalali, Theory of amplified dispersive fourier transformation, *Physical Review A* 80 (4) (2009) 043821.
- [62] Y. Yichuan, R. Lewen, S. Irmscher, U. Westergren, L. Thylen, U. Eriksson, W. S. Lee, 80 gb/s etdm transmitter with a traveling-wave electroabsorption modulator, 2005 Optical Fiber Communications Conference Technical Digest (IEEE Cat. No. 05CH37672) (2005) 3 pp. Vol. 3–3 pp. Vol. 3Cited Reference Count: 14 8613479 2005 Optical Fiber Communications Conference Technical Digest 6-11 March 2005 Anaheim, CA, USA IEEE/ComSoc, Commun. Soc.; IEEE/LEOS, Lasers and Electro-Optics Soc.; Optical Soc. of America Ieee 1 55752 783 0.
- [63] G. P. Agrawal, *Lightwave technology : components and devices*, J. Wiley, Hoboken, NJ, 2004, Ch. 6, pp. xiv, 427 p.
- [64] Y. Han, B. Jalali, Time-bandwidth product of the photonic time-stretched analog-to-digital converter, *Ieee Transactions on Microwave Theory and Techniques* 51 (7) (2003) 1886–1892, 696RW Times Cited:21 Cited References Count:13.

- [65] S. Gupta, G. C. Valley, B. Jalali, Distortion cancellation in time-stretch analog-to-digital converter, *Journal of Lightwave Technology* 25 (12) (2007) 3716–3721, 245OA Times Cited:13 Cited References Count:12.
- [66] A. Motafakker-Fard, S. Gupta, B. Jalali, Eye diagram measurements and equalization with real-time burst sampling, 2010 IEEE International Instrumentation and Measurement Technology Conference - I2MTC 2010 (2010) 1030–1032 Cited Reference Count: 23 11501768 2010 IEEE International Instrumentation and Measurement Technology Conference - I2MTC 2010 3-6 May 2010 Austin, TX, USA Ieee 978-1-4244-2832-8.
- [67] G. P. Agrawal, *Nonlinear Fiber Optics*, 4th Ed., Academic Press, Burlington, MA, 2007, Ch. 3, pp. 51–78.
- [68] C. J. McKinstrie, S. Radic, A. R. Chraplyvy, Parametric amplifiers driven by two pump waves, *Ieee Journal of Selected Topics in Quantum Electronics* 8 (3) (2002) 538–547, 570VT Times Cited:143 Cited References Count:16.
- [69] R. H. Stolen, J. E. Bjorkholm, Parametric amplification and frequency-conversion in optical fibers, *Ieee Journal of Quantum Electronics* 18 (7) (1982) 1062–1072, nw199 Times Cited:370 Cited References Count:40.
- [70] S. Radic, Parametric amplification and processing in optical fibers, *Laser and Photonics Reviews* 2 (6) (2008) 498–513, 392AT Times Cited:11 Cited References Count:55.
- [71] K. Inoue, H. Toba, Wavelength conversion experiment using fiber 4-wave-mixing, *Ieee Photonics Technology Letters* 4 (1) (1992) 69–72, gy848 Times Cited:119 Cited References Count:15.
- [72] C. J. McKinstrie, A. H. Gnauck, S. Radic, All-optical signal processing by fiber-based parametric devices, *Optics and Photonics News* 18 (3) (2007) 34–40, cited Reference Count: 9 9532813 *Usa Opt. Soc. America*.
- [73] A. Yariv, D. M. Pepper, Amplified reflection, phase conjugation, and oscillation in degenerate four-wave mixing, *Optics Letters* 1 (1) (1977) 16–18, cited Reference Count: 8 1117806 *Usa*.
- [74] M. Skold, M. Westlund, H. Sunnerud, P. A. Andrekson, All-optical waveform sampling in high-speed optical communication systems using advanced modulation formats, *Journal of Lightwave Technology* 27 (16) (2009) 3662–3671, cited Reference Count: 35 10858748 *Usa Ieee*.
- [75] N. K. Fontaine, R. P. Scott, L. J. Zhou, F. M. Soares, J. P. Heritage, S. J. B. Yoo, Real-time full-field arbitrary optical waveform measurement, *Nature Photonics* 4 (4) (2010) 248–254, 585OP Times Cited:40 Cited References Count:50.
- [76] B. H. Kolner, M. Nazarathy, Temporal imaging with a time lens, *Optics Letters* 14 (12) (1989) 630–632, ab709 Times Cited:151 Cited References Count:11.

- [77] C. V. Bennett, B. H. Kolner, Upconversion time microscope demonstrating 103x magnification of femtosecond waveforms, *Optics Letters* 24 (11) (1999) 783–785, 201GZ Times Cited:81 Cited References Count:21.
- [78] R. Salem, M. A. Foster, A. C. Turner, D. F. Geraghty, M. Lipson, A. L. Gaeta, Optical time lens based on four-wave mixing on a silicon chip, *Optics Letters* 33 (10) (2008) 1047–1049, 310HW Times Cited:43 Cited References Count:16.
- [79] B. Jalali, D. R. Solli, S. Gupta, Silicon’s time lens, *Nature Photonics* 3 (1) (2009) 8–10, iSI Document Delivery No.: 393SZ Times Cited: 7 Cited Reference Count: 14 Jalali, B. Solli, D. R. Gupta, S. Nature publishing group London.
- [80] J. Chou, G. A. Seffler, J. Conway, G. C. Valley, B. Jalali, 4-channel continuous-time 77 gsa/s adc using photonic bandwidth compression, 2007 International Topical Meeting Microwave Photonics (2007) 54–57Cited Reference Count: 10 9812444 2007 International Topical Meeting Microwave Photonics 3-5 Oct. 2007 Victoria, BC, Canada Ieee.
- [81] A. M. Fard, P. T. S. DeVore, D. R. Solli, B. Jalali, Impact of optical nonlinearity on performance of photonic time-stretch analog-to-digital converter, *Journal of Lightwave Technology* 29 (13) (2011) 2025–2030, 777YL Times Cited:1 Cited References Count:19.
- [82] B. W. Buckley, A. M. Madni, B. Jalali, Coherent time-stretch transformation for real-time capture of wide-band signals, *Optics Express*.
- [83] G. P. Agrawal, *Fiber-Optic Communication Systems*, 3rd Ed., John Wiley and Sons, Inc., New York, 2002, Ch. 10.
- [84] T. Okoshi, Recent advances in coherent optical fiber communication-systems, *Journal of Lightwave Technology* 5 (1) (1987) 44–52.
- [85] P. J. Winzer, R. J. Essiambre, Advanced modulation formats for high-capacity optical transport networks, *Journal of Lightwave Technology* 24 (12) (2006) 4711–4728.
- [86] K. Goda, B. Jalali, Dispersive fourier transformation for fast continuous single-shot measurements, *Nature Photonics* 7 (2) (2013) 102–112.
- [87] E. Ip, A. P. T. Lau, D. J. F. Barros, J. M. Kahn, Coherent detection in optical fiber systems (vol 16, pg 753, 2008), *Optics Express* 16 (26) (2008) 21943–21943.
- [88] E. Ip, J. M. Kahn, Compensation of dispersion and nonlinear impairments using digital backpropagation, *Journal of Lightwave Technology* 26 (17-20) (2008) 3416–3425.
- [89] M. G. Taylor, Coherent detection method using dsp for demodulation of signal and subsequent equalization of propagation impairments, *IEEE Photonics Technology Letters* 16 (2) (2004) 674–676676.



- [90] E. Tokunaga, A. Terasaki, T. Kobayashi, Frequency-domain interferometer for femtosecond time-resolved phase spectroscopy, *Optics letters* 17 (16) (1992) 1131–1133.
- [91] Matlab release 2012a.
- [92] L. Cohen, *Time-frequency analysis*, Prentice Hall PTR, Englewood Cliffs, N.J, 1995, Ch. 2, pp. xv, 299 p.
- [93] T. Kawanishi, K. Kogo, S. Oikawa, M. Izutsu, Direct measurement of chirp parameters of high-speed mach-zehnder-type optical modulators, *Optics Communications* 195 (5-6) (2001) 399–404.
- [94] D. C. Kilper, R. Bach, D. J. Blumenthal, D. Einstein, T. Landolsi, L. Ostar, A. Preiss, A. E. Willner, Optical performance monitoring, *Journal of Lightwave Technology* 22 (1) (2004) 294–304, 774VX Times Cited:220 Cited References Count:66.
- [95] S. Wielandy, M. Fishteyn, B. Y. Zhu, Optical performance monitoring using nonlinear detection, *Journal of Lightwave Technology* 22 (3) (2004) 784–793, 809JU Times Cited:72 Cited References Count:25.
- [96] Z. Q. Pan, C. Y. Yu, A. E. Willner, Optical performance monitoring for the next generation optical communication networks, *Optical Fiber Technology* 16 (1) (2010) 20–45, iSI Document Delivery No.: 555AM Times Cited: 47 Cited Reference Count: 144 Pan, Zhongqi Yu, Changyuan Willner, Alan E. Elsevier science inc New york.
- [97] G. C. Valley, Photonic analog-to-digital converters, *Optics Express* 15 (5) (2007) 1955–1982, 142WW Times Cited:149 Cited References Count:152.
- [98] G. P. Agrawal, *Fiber-optic communication systems*, 4th Edition, Wiley, Hoboken, N.J., 2010, Ch. 4, pp. 478–517.
- [99] A. M. Madni, *Frequency domain reflectometry and digital signal processing solution to transmission lines/antenna systems analysis*”, Ph.D. thesis, California Coast University (1987).
- [100] Z. Tarczy-Hornoc, A. M. Madni, J. M. Fala, Transmission line analyzer for automatically identifying the severities and locations of multiple mismatches (December 6 1986).
- [101] A. M. Madni, Z. T. Hornoch, Microprocessor based fault finder pinpoints transmission line faults within inches and within minutes, *Microwave Journal, International Edition* 24 (11) (1981) 49–57.
- [102] A. M. Madni, E. J. Nyiri, Fast fourier transform and digital filtering solution to transmission line analysis, in: *Military Microwaves Conference, Microwave Exhibitions and Publishers Limited*, 1983, pp. 423–428.

- [103] D. C. Kilper, R. Bach, D. J. Blumenthal, D. Einstein, T. Landolsi, L. Ostar, A. Preiss, A. E. Willner, Optical performance monitoring, *Journal of Lightwave Technology* 22 (1) (2004) 294–304, iSI Document Delivery No.: 774VX Times Cited: 220 Cited Reference Count: 66 Kilper, DC Bach, R Blumenthal, DJ Einstein, D Landolsi, T Ostar, L Preiss, A Willner, AE Conference on Optical Fiber Communications Conference (OCF) 2003 Atlanta, georgia u Ieee-inst electrical electronics engineers inc Piscataway.
- [104] [7 series fpgas overview](#) (2012).  
URL [http://www.xilinx.com/support/documentation/data\\_sheets/ds180\\_7Series\\_Overview.pdf](http://www.xilinx.com/support/documentation/data_sheets/ds180_7Series_Overview.pdf)
- [105] M. B. Gokhale, C. D. Rickett, J. L. Tripp, C. H. Hsu, R. Scrofano, Promises and pitfalls of reconfigurable supercomputing, in: *Conf. Eng. of Reconfigurable Systems and Algorithms*, CSREA Press, 2006, pp. 11–20.
- [106] E. Diebold, B. W. Buckley, D. Gosset, B. Jalali, Digitally synthesized beat frequency multiplexing for sub-millisecond fluorescence microscopy, *Nature Photonics*.
- [107] K. Goda, K. K. Tsia, B. Jalali, Serial time-encoded amplified imaging for real-time observation of fast dynamic phenomena, *Nature* 458 (7242) (2009) 1145–U80, goda, K. Tsia, K. K. Jalali, B.
- [108] M. J. E. Golay, Complementary series, *Ire Transactions on Information Theory* 7 (2) (1961) 82, 10750 Times Cited:524 Cited References Count:0.
- [109] E. H. Young, S. K. Yao, Design considerations for acoustooptic devices, *Proceedings of the Ieee* 69 (1) (1981) 54–64, kz962 Times Cited:44 Cited References Count:41.
- [110] J. R. Lakowicz, K. W. Berndt, Lifetime-selective fluorescence imaging using an rf phase-sensitive camera, *Review of Scientific Instruments* 62 (7) (1991) 1727–1734, fu522 Times Cited:162 Cited References Count:50.
- [111] D. Basiji, W. Ortyrn, Imaging and analyzing parameters of small moving objects such as cells (03/29/2000 2001).
- [112] W. J. Allard, J. Matera, M. C. Miller, M. Repollet, M. C. Connelly, C. Rao, A. G. J. Tibbe, J. W. Uhr, L. W. M. M. Terstappen, Tumor cells circulate in the peripheral blood of all major carcinomas but not in healthy subjects or patients with nonmalignant diseases, *Clinical Cancer Research* 10 (20) (2004) 6897–6904, 864IO Times Cited:356 Cited References Count:38.
- [113] S. Nagrath, L. V. Sequist, S. Maheswaran, D. W. Bell, D. Irimia, L. Ulkus, M. R. Smith, E. L. Kwak, S. Digumarthy, A. Muzikansky, P. Ryan, U. J. Balis, R. G. Tompkins, D. A. Haber, M. Toner, Isolation of rare circulating tumour cells in cancer patients by microchip technology, *Nature* 450 (7173) (2007) 1235–U10, 243HA Times Cited:551 Cited References Count:32.

- [114] S. S. Howard, A. Straub, N. G. Horton, D. Kobat, C. Xu, Frequency-multiplexed in vivo multiphoton phosphorescence lifetime microscopy, *Nat Photon* 7 (1) (2013) 33–37, 10.1038/nphoton.2012.307.
- [115] H. C. Wu, Analysis and characterization of intercarrier and interblock interferences for wireless mobile ofdm systems, *Ieee Transactions on Broadcasting* 52 (2) (2006) 203–210, 048OK Times Cited:30 Cited References Count:24.
- [116] J. S. Sanders, R. G. Driggers, C. E. Halford, S. T. Griffin, Imaging with frequency-modulated reticles, *Optical Engineering* 30 (11) (1991) 1720–1724, gp209 Times Cited:7 Cited References Count:5.
- [117] G. Futia, P. Schlup, D. G. Winters, R. A. Bartels, Spatially-chirped modulation imaging of absorption and fluorescent objects on single-element optical detector, *Optics Express* 19 (2) (2011) 1626–1640, 707US Times Cited:5 Cited References Count:46.
- [118] R. v. Nee, R. Prasad, OFDM for wireless multimedia communications, Artech House universal personal communications series, Artech House, Boston, 2000, 99052312 Richard van Nee, Ramjee Prasad. ill. ; 24 cm. Includes bibliographical references and index.
- [119] K. H. Kim, C. Buehler, K. Bahlmann, T. Ragan, W. C. A. Lee, E. Nedivi, E. L. Heffer, S. Fantini, P. T. C. So, Multifocal multiphoton microscopy based on multianode photomultiplier tubes, *Optics Express* 15 (18) (2007) 11658–11678, 208SP Times Cited:21 Cited References Count:39.
- [120] J. M. Kralj, A. D. Douglass, D. R. Hochbaum, D. Maclaurin, A. E. Cohen, Optical recording of action potentials in mammalian neurons using a microbial rhodopsin, *Nature Methods* 9 (1) (2012) 90–U130, 870KB Times Cited:3 Cited References Count:34.