

# UC Davis

## Guidelines

### Title

Pavement Preservation Studies Technical Advisory Guide

### Permalink

<https://escholarship.org/uc/item/1ck9r6jd>

### Author

Jones, D.

### Publication Date

2007

January 2007

Guideline: UCPRC-GL-2005-01

---

# Pavement Preservation Studies Technical Advisory Guide

**Author: D. Jones**

Partnered Pavement Research Program (PPRC) Contract Strategic Plan Element 3.2.9:  
Development of Guidelines for Effective Maintenance Treatment Evaluation Test  
Sections

---

**PREPARED FOR:**

California Department of Transportation  
Division of Research and Innovation  
Office of Roadway Research

**PREPARED BY:**

University of California  
Pavement Research Center  
UC Davis, UC Berkeley

---





**Title:** Pavement Preservation Studies Technical Advisory Guide

**Author:** D. Jones

**Prepared for:**

Caltrans

**FHWA No:**

S/CA/RI-2006/25

**Date:**

January 2007

**Strategic Plan No:**

3.2.9

**Client Reference No:**

SPE 3.2.9

**Status:**

Final

**Abstract:**

This document provides guidelines for the establishment, monitoring and reporting of pavement preservation experiments in California. Information is provided in chapters covering:

- Management and responsibilities
- Project fundamentals
- Experiment work plan
- Site selection
- Experiment construction
- Experiment monitoring
- Forensic investigations
- Laboratory testing
- Data analysis, reports and implementation
- Data management and documentation
- Example experiment work plans, checklists and forms

The document aims to assist with achieving successful completion of experiments and implementation of the findings.

**Keywords:**

Pavement preservation, experiment evaluation

**Proposals for implementation:**

Follow protocol in all future pavement preservation and innovative product experiments. Update as required.

**Related documents:**

**Pavement Preservation Studies Technical Advisory Guide (UCPRC-GL-2005-01)**

**Signatures:**

D. Jones  
1<sup>st</sup> Author

J. Harvey  
Technical  
Review

D. Spinner  
Editor

J. Harvey  
Principal  
Investigator

M. Samadian  
Caltrans Contract  
Manager





## **DISCLAIMER**

---

The contents of this report reflect the views of the authors who are responsible for the facts and accuracy of the data presented herein. The contents do not necessarily reflect the official views or policies of the State of California or the Federal Highway Administration. This report does not constitute a standard, specification, or regulation.

## **DOCUMENT REVIEW AND IMPLEMENTATION STATUS**

---

This document has been reviewed within the University of California Pavement Research Center, by the Caltrans Division of Research and Innovation, and by the Caltrans Division of Maintenance, Office of Pavement Preservation and its appointed reviewers.

The document can be used as a guide for the design, construction, and assessment of pavement preservation experiments. The document is released as a draft for implementation for a period of 12 months, ending December 2007. Any comments or recommendations to improve the document, based on use during implementation, should be forwarded to the Chief of the Office of Pavement Preservation. A revised document, incorporating comments received, will be released in January 2008.



## **PROJECT OBJECTIVES**

---

The objective of this project is to improve the quality of data and analyses obtained from Pavement Preservation and Innovative Product Experiments in California, and promote statewide implementation of the findings of successful studies.

This objective will be met after completion of three tasks:

1. Prepare and discuss a draft table of contents for a detailed guideline on undertaking pavement preservation and innovative product experiments
2. Prepare a detailed guideline
3. Prepare a summarized “glove-box” version of the detailed guideline

This document addresses Task No 2.



# TABLE OF CONTENTS

---

<b>LIST OF TABLES .....</b>	<b>xii</b>
<b>LIST OF FIGURES.....</b>	<b>xiii</b>
<b>PURPOSE OF THIS GUIDELINE .....</b>	<b>xv</b>
<b>1. INTRODUCTION.....</b>	<b>1</b>
1.1. Background.....	1
1.2. Pavement Preservation Definitions.....	3
1.3. Key Activities.....	4
1.4. Typical Pavement Preservation Activities.....	5
1.5. Quality Management.....	6
1.5.1 Caltrans Project Delivery Quality Management Plan .....	7
<b>2. MANAGEMENT AND RESPONSIBILITIES.....</b>	<b>9</b>
2.1. Introduction .....	9
2.2. Staffing.....	10
2.2.1 Project Champion .....	11
2.2.2 Project Engineer/Project Manager .....	11
2.2.3 Database Manager.....	12
2.2.4 Instrumentation Technician .....	13
2.2.5 Evaluation Team.....	13
<b>3. PROJECT FUNDAMENTALS .....</b>	<b>15</b>
3.1. Introduction .....	15
3.2. Study Proposals.....	16
3.2.1 Pre-proposal.....	17
3.2.2 Background Study .....	17
3.2.3 Full Proposal.....	18
3.3. Experimental Design.....	20
3.3.1 Terminology.....	20
3.3.2 Types of Experiment.....	22
3.3.3 Factorial Experimental Designs.....	23
3.3.4 Replicate Studies.....	25
3.3.5 Evaluation Criteria .....	25
3.3.6 Failure Criteria .....	26
3.3.7 Experiment Completion .....	26
3.4. Quality Management.....	26
3.4.1 Documentation Management .....	27
3.4.2 Responsibility .....	27

<b>4.</b>	<b>EXPERIMENT WORK PLAN.....</b>	<b>29</b>
4.1.	Introduction .....	29
4.2.	Procedure .....	30
4.2.1	Project Planning Meeting .....	30
4.2.2	Work Plan Write-up .....	31
4.2.3	Work Plan Review .....	32
4.2.4	Approval .....	32
4.3.	Experiment Work Plan Content .....	32
4.4.	Experiment Work Plan Format.....	34
4.4.1	Table of Contents .....	34
4.4.2	Title and Numbering .....	34
4.4.3	Example.....	35
4.5.	Experiment Initiation .....	35
4.6.	Revisions .....	35
4.7.	Quality Management.....	35
4.7.1	Documentation Management .....	36
4.7.2	Responsibility .....	36
<b>5.</b>	<b>SITE SELECTION.....</b>	<b>37</b>
5.1.	Introduction .....	37
5.2.	Procedure .....	38
5.2.1	Desktop Study .....	39
5.2.2	Site Visit.....	40
5.2.3	Safety Considerations .....	43
5.2.4	Environmental Considerations .....	43
5.2.5	Other Considerations.....	43
5.2.6	Preliminary Site Report and Approval .....	44
5.3.	Experimental Section Numbering .....	44
5.4.	Experimental Section Layout and Marking .....	45
5.5.	Instrument Installation.....	46
5.6.	Weather Station .....	47
5.7.	Checklists.....	47
5.8.	Final Site Report and Approval.....	47
5.9.	Quality Management.....	47
5.9.1	Data Management .....	48
5.9.2	Responsibility .....	48
<b>6.</b>	<b>EXPERIMENT CONSTRUCTION.....</b>	<b>49</b>
6.1.	Introduction .....	49
6.2.	Pre-Construction Assessment .....	50

6.2.1	Reference Standards .....	51
6.3.	Construction Assessment .....	52
6.3.1	Proprietary Products.....	52
6.3.2	Observation .....	53
6.3.3	Measurement.....	54
6.3.4	Reference Standards .....	55
6.4.	Material Sampling .....	55
6.4.1	Reference Standards .....	57
6.5.	Instrument Installation.....	57
6.5.1	Reference Standards .....	57
6.6.	Checklists.....	57
6.7.	Construction Report and Approval.....	57
6.8.	Quality Management.....	58
6.8.1	Data Management.....	58
6.8.2	Responsibility .....	59
<b>7.</b>	<b>EXPERIMENT MONITORING .....</b>	<b>61</b>
7.1.	Introduction .....	61
7.2.	Background.....	62
7.2.1	Attributes Of Distress.....	62
7.2.2	Training and Calibration of Evaluators .....	67
7.3.	Operational Issues .....	68
7.3.1	Notifications .....	68
7.3.2	Equipment .....	68
7.3.3	Road Closures and Traffic Control .....	69
7.4.	Monitoring Timetable .....	69
7.5.	Protocols and Criteria .....	70
7.5.1	Failure Criteria.....	70
7.5.2	Reference Standards .....	71
7.6.	Visual Assessment.....	71
7.6.1	Reference Standards .....	73
7.7.	Measurements .....	73
7.7.1	Reference Standards .....	75
7.8.	Failure Investigations.....	75
7.9.	Sampling .....	75
7.9.1	Reference Standards .....	76
7.10.	Forensic Studies.....	76
7.11.	Checklists .....	76
7.12.	Quality Management .....	76



7.12.1	Quality Control.....	77
7.12.2	Data Management.....	77
7.12.3	Responsibility .....	78
<b>8.</b>	<b>FORENSIC INVESTIGATIONS .....</b>	<b>79</b>
8.1.	Introduction .....	79
8.2.	Record of Decision.....	81
8.3.	Level of Detail .....	82
8.4.	Close-out Monitoring.....	84
8.5.	Level 1 Forensic Assessments .....	84
8.6.	Test Pit Location .....	84
8.7.	Coring .....	87
8.7.1	Reference Standards .....	87
8.7.2	Equipment .....	88
8.7.3	Procedure .....	88
8.7.4	Core Logging .....	89
8.8.	Test Pit Excavation .....	89
8.8.1	Reference Standards .....	89
8.8.2	Equipment .....	89
8.8.3	Procedure .....	90
8.8.4	Excess Materials .....	92
8.9.	Marking, Packaging and Shipping .....	92
8.9.1	General Provisions .....	92
8.9.2	Sample Code Number.....	92
8.9.3	Labels and Tags .....	93
8.9.4	Packaging.....	94
8.9.5	Shipping.....	94
8.10.	Core and Test Pit Logging.....	94
8.10.1	Reference Standards .....	95
8.10.2	Logging Procedure .....	95
8.11.	In-pit Testing.....	104
8.11.1	Reference Standards .....	104
8.11.2	In situ Density and Moisture Measurements .....	104
8.11.3	Dynamic Cone Penetrometer (DCP) Testing .....	106
8.11.4	Other Testing.....	106
8.12.	Test Pit Repair .....	106
8.12.1	Asphalt Concrete Pavements.....	106
8.12.2	Portland Cement Concrete Pavements.....	107
8.12.3	Site Cleanup.....	107

8.13.	Project Site Report .....	108
8.14.	Checklists .....	108
8.15.	Quality Management .....	108
8.15.1	Data Management.....	108
8.15.2	Responsibility .....	109
<b>9.</b>	<b>LABORATORY TESTING .....</b>	<b>111</b>
9.1.	Introduction .....	111
9.2.	Tests .....	112
<b>10.</b>	<b>DATA ANALYSIS, REPORTS AND IMPLEMENTATION .....</b>	<b>113</b>
10.1.	Introduction.....	113
10.2.	Data Analysis.....	114
10.3.	Reports .....	114
10.3.1	Construction Reports.....	114
10.3.2	Progress Reports.....	115
10.3.3	Experiment (Research) Reports.....	115
10.3.4	Implementation Reports .....	116
10.4.	Implementation .....	116
<b>11.</b>	<b>DATA MANAGEMENT AND DOCUMENTATION .....</b>	<b>119</b>
11.1.	Introduction.....	119
11.2.	Project File.....	119
11.3.	Checklists .....	120
11.4.	Data Collection Forms .....	120
11.5.	Numbering Systems .....	121
11.5.1	Experiment Proposal Register.....	121
11.5.2	Experiment Register .....	122
11.5.3	Report Number Register .....	123
11.6.	Data Validation and Storage.....	124
11.7.	Project Closure .....	125
<b>12.</b>	<b>BIBLIOGRAPHY .....</b>	<b>127</b>
	<b>APPENDIX A: PROPOSED CALTRANS INNOVATION PROCESS .....</b>	<b>130</b>
	<b>APPENDIX B: CHECKLISTS .....</b>	<b>138</b>
	<b>APPENDIX C: EXAMPLE EXPERIMENT WORK PLAN .....</b>	<b>154</b>
	<b>APPENDIX D: DATA COLLECTION FORMS.....</b>	<b>162</b>
	<b>APPENDIX E: EXAMPLE SAMPLE LABEL .....</b>	<b>180</b>

## LIST OF TABLES

---

Table 1.1: Pavement preservation purpose .....	3
Table 1.2: Typical pavement preservation activities .....	6
Table 3.1: Example layout of factorial experimental design.....	25
Table 7.1: General description of degree classification .....	64
Table 7.2: General description of extent classifications .....	65
Table 7.3: Examples of physical measurements.....	73
Table 8.1: Forensic investigations associated with pavement preservation activities .....	80
Table 8.2: Checklist for test pit logging (wearing course) .....	100
Table 8.3: Severity and extent descriptors for wearing course layer assessment.....	101
Table 8.4: Checklist for test pit logging (bound layers) .....	102
Table 8.5: Severity and extent descriptors for bound layer assessment .....	102
Table 8.6: Checklist for test pit logging (unbound layers) .....	103
Table 8.7: Severity and extent descriptors for unbound layer assessment .....	103

## LIST OF FIGURES

---

Figure 1.1: Components of pavement preservation .....	1
Figure 1.2: Flowchart of key activities .....	5
Figure 2.1: Typical staff organization chart for pavement preservation experiments .....	11
Figure 3.1: Flowchart for project approval.....	16
Figure 3.2: Flowchart for background study.....	19
Figure 3.3: Flowchart for factorial experimental design .....	24
Figure 4.1: Flowchart for development of an experiment work plan .....	30
Figure 5.1: Flowchart for site selection.....	38
Figure 5.2: Example layout of experimental section (one lane width).....	45
Figure 6.1: Flowchart for experiment construction .....	50
Figure 7.1: Flowchart for experiment monitoring.....	62
Figure 7.2: Flow diagram – five point classification system .....	65
Figure 7.3: Diagrammatical illustration of extent .....	66
Figure 8.1: Flowchart for forensic investigations .....	81
Figure 8.2: Flowchart for determining level of detail of the forensic investigation.....	83
Figure 8.3: Test pit layout.....	86
Figure 8.4: Examples of core locations on asphalt concrete sections .....	86
Figure 8.5: Examples of core locations on portland cement concrete sections .....	87
Figure 8.6: Plan view of test pit face to be logged .....	96
Figure 8.7: Zoning of the test pit face.....	96



## PURPOSE OF THIS GUIDELINE

---

This guideline has been written to assist Caltrans staff with establishing and monitoring pavement preservation experiments. Experience has shown that, although numerous such experiments have been built in the past, very little useful information that can be used to make informed decisions about implementing the treatment, technology, procedure or product state-wide results. There are a number of reasons for this including movement and turnover of staff, inappropriate experimental designs, insufficient data collection and/or loss of interest over time (i.e., experiment is never completed). Considerable time and expense are incurred during the establishment of experiments. Failure to complete an experiment invariably means that it will be repeated by someone else, somewhere else at a later date. The same applies to experiments that although completed, are not coordinated at state level.

This guideline provides direction on the following:

- Establishing a study team and assigning responsibilities
- Justification for doing an experiment
- Developing an experiment work plan
- Locating, marking out and establishing the site
- Construction of the experiment
- Monitoring the experiment
- Data analysis
- Reporting and implementation
- Data management

By applying the principles discussed in the guideline, the following can be achieved:

- Statistically valid, scientifically correct and defensible answers obtained within a determined time period
- Results from every experiment established, regardless of the movement of individuals within and out of the organization
- Findings that are applicable state-wide and useable by individuals outside the study
- Justification for expenses incurred
- Justification for statewide implementation
- Justification for changes to specifications and practices
- Accountability of individuals involved
- Prevention of duplication of effort



# 1. INTRODUCTION

## 1.1. Background

Pavement preservation represents a proactive approach in maintaining highways. It enables State Departments of Transportation (DoTs) to reduce costly, time consuming rehabilitation and reconstruction projects, and the associated traffic disruptions. With timely preservation the traveling public can be provided with improved safety and mobility, reduced congestion, and smoother, longer lasting pavements.

A Pavement Preservation program consists primarily of three components (Figure 1.1):

- Preventive maintenance
- Minor rehabilitation (non structural)
- Routine maintenance activities

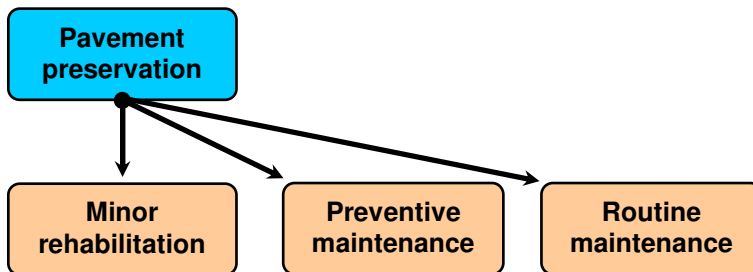


Figure 1.1: Components of pavement preservation

Caltrans invests millions of dollars each year in pavement preservation activities. Documented performance of the pavement preservation practices during these activities is important so that Caltrans can determine which alternatives are most appropriate under particular circumstances. Many factors contribute to this decision including:

- Nature of the problem requiring maintenance
- Existing pavement geometry
- Construction materials
- Location (District)
- Traffic
- Safety



MTAG



Crack seal



Shoulder fog seal



Diamond grinding





- Environment
- Cost
- Current practice and available equipment

To establish the most appropriate pavement preservation practice or to assess the performance and effectiveness of new materials or equipment, experiments are usually constructed and then monitored over a period of time. Provided that an appropriate experimental design is followed, the experiment is monitored regularly and objectively and the data is suitably interpreted, these experiments can contribute significantly to the understanding of pavement preservation and the state-wide implementation/ adoption of the most appropriate and cost-effective practices.

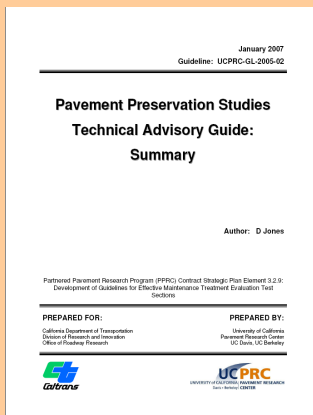
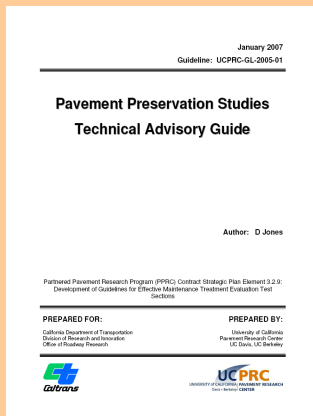
However, in many instances, the purpose of the experiment is not clearly defined, accepted monitoring standards are not adhered to, data are not effectively captured, and the experiment is not completed with a result on which a decision can be made with regard to state-wide implementation. Alternatively, the originator of the experiment moves and his/her successor may not be aware or may not be willing to sustain the exercise. Consequently, inconclusive results are often obtained and the new procedure or practice is not adopted. Invariably, the experiment is repeated elsewhere by another individual, often with the same inconclusive result.

The purpose of this document is to provide Caltrans personnel with guidelines for the consistent design, construction and monitoring of experimental sections, capturing and storing data and interpreting and documenting the results. This guideline supplements the “Maintenance Technical Advisory Guide (MTAG)” and the “Guide to the Investigation and Remediation of Distress in Flexible Pavements” and uses information from those documents as well as past test section project evaluations located throughout the State of California.

The document is presented in two parts:

- A comprehensive document providing detailed information on establishing and monitoring pavement preservation test sections (this document).
- A summary guide in the form of brief descriptions and checklists on key components of establishing and monitoring pavement preservation test sections.

*The purpose of this document is to provide Caltrans personnel with guidelines for the consistent design, construction, and monitoring of experimental sections, capturing and storing data, and interpreting and documenting the results.*



## 1.2. Pavement Preservation Definitions

The distinctive characteristics of pavement preservation activities compared to construction, rehabilitation and emergency maintenance are that they restore the function of the existing roadway system and extend its service life, but do not increase capacity or strength (Table 1.1).

**Table 1.1: Pavement preservation purpose**

Category	Activity	Purpose			
		Increase capacity	Increase strength	Reduce aging	Restore serviceability
Construction	New construction	✓	✓	✓	✓
	Reconstruction	✓	✓	✓	✓
Rehabilitation	Major rehabilitation		✓	✓	✓
	Structural overlay		✓	✓	✓
Pavement Preservation	Minor rehabilitation			✓	✓
	Preventive maintenance			✓	✓
	Routine maintenance			✓	✓
Maintenance	Reactive maintenance				✓
	Catastrophic maintenance				✓

Different pavement preservation terminology is often used by local and State DoTs. This can cause inconsistency relating to how preservation programs are applied and their effectiveness measured. To overcome these inconsistencies, the Federal Highway Administration (FHWA) has proposed a number of definitions (*FHWA Memorandum on Pavement Preservation Definitions, 09/12/05*).

- Pavement Preservation** is “a program employing a network level, long-term strategy that enhances pavement performance by using an integrated, cost-effective set of practices that extend pavement life, improve safety and meet motorist expectations.” (*FHWA Pavement Preservation Expert Task Group*)
- Preventive Maintenance** is “a planned strategy of cost-effective treatments to an existing roadway system and its appurtenances that preserves the system, retards future deterioration, and maintains or improves the functional condition of the system (without significantly increasing the structural capacity).” (*AASHTO Standing Committee on Highways, 1997*)
- Minor rehabilitation** consists of non-structural enhancements made to the existing pavement sections to eliminate age-related, top-down surface cracking that develop in flexible pavements due to environmental exposure. Because of the non-structural nature of minor rehabilitation techniques, these types of rehabilitation techniques are placed in the category of pavement preservation.



*Pavement preservation - chip seal*



*Preventive maintenance - dowel bar retrofit*



Routine maintenance - crack repair



Pavement reconstruction



Major rehabilitation



Corrective maintenance



Catastrophic maintenance

- **Routine Maintenance** “consists of work that is planned and performed on a routine basis to maintain and preserve the condition of the highway system or to respond to specific conditions and events that restore the highway system to an adequate level of service.” *Source: AASHTO Highway Subcommittee on Maintenance*

Definitions of the other activities listed in Table 1.1 are:

- **Pavement Reconstruction** is required when a pavement has either failed or has become functionally obsolete. It entails the replacement of the entire existing pavement structure with an equivalent or increased pavement structure.
- **Major Rehabilitation** consists of “structural enhancements that extend the service life of an existing pavement and/or improve its load carrying capacity. Rehabilitation techniques include restoration treatments and structural overlays.” *Source: AASHTO Highway Subcommittee on Maintenance*
- **Corrective Maintenance** activities are performed in response to the development of a deficiency or deficiencies that negatively impact the safe, efficient operations of the facility and future integrity of the pavement section. Corrective maintenance activities are generally reactive, not proactive, and performed to restore a pavement to an acceptable level of service due to unforeseen conditions.
- **Catastrophic Maintenance** describes work activities generally necessary to return a roadway facility back to a minimum level of service while a permanent restoration is being designed and scheduled. Examples of situations requiring catastrophic pavement maintenance activities include concrete pavement blow-ups, road washouts, avalanches, or rockslides.

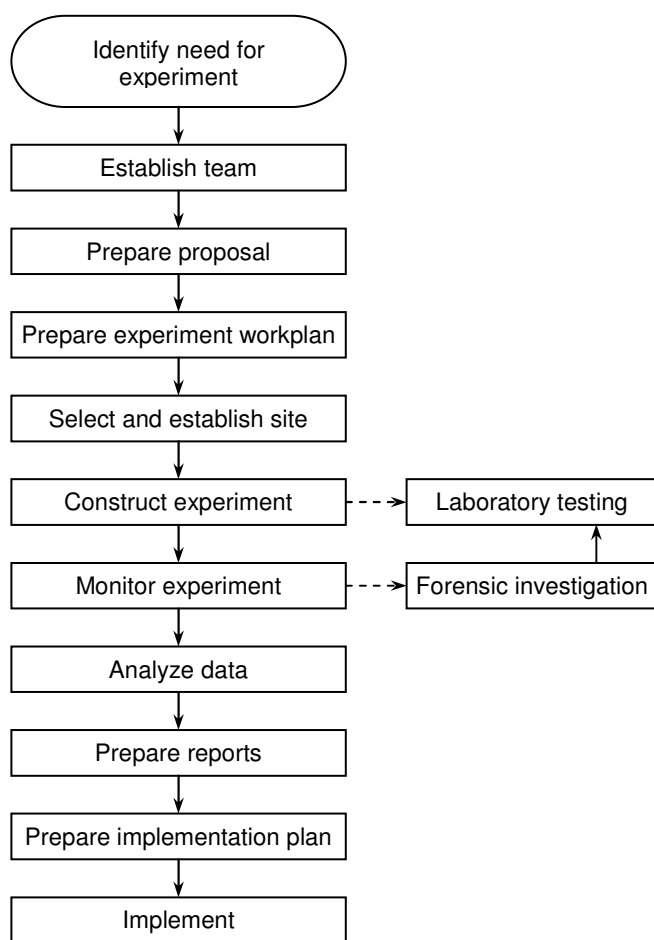
### 1.3. Key Activities

The design, construction, monitoring and reporting of experimental sections can be divided into a number of key activities, all of which are equally important in ensuring that relevant data are captured and interpreted in such way that an informed decision can be taken on the implementation of the findings of an experiment. These activities include:

- Delegating responsibility
- Preparing an experimental design

- Selecting and establishing a suitable site
- Construction
- Monitoring
- Forensic studies
- Laboratory testing
- Data management
- Reporting and implementation

A flow chart of the process is provided in Figure 1.2. Each activity is discussed in more detail in the following chapters.



**Figure 1.2: Flowchart of key activities**

#### 1.4. Typical Pavement Preservation Activities

Various pavement preservation activities are performed on highways. Certain activities are preventive in that they are performed before any significant distress



*Fog seal*





*Slurry seal*



*Microsurfacing*



*Thin overlay*

*Quality management is the coordination of activities to direct and control an organization with regard to quality.*

has occurred. Others are remedial and are carried out to repair distresses in the pavement. Many routine activities are unlikely to be assessed in research experiments and will not be covered in any detail in this document. Typical activities that may well be researched are listed in Table 1.2. The list is not exhaustive and only provides an example of activities commonly investigated in pavement preservation experiments. The list does include issues such as drainage, pavement markings, barriers, water crossings and vegetation control, although investigations can be undertaken on these with a view to improving techniques or assessing new products.

**Table 1.2: Typical pavement preservation activities**

Activity*	Area treated	Preventive	Remedial
Thin overlays	Total	✓	✓
Ultra-thin overlays		✓	✓
Bonded wearing course		✓	✓
Microsurfacing		✓	✓
Chip seals		✓	✓
Slurry seals		✓	✓
Fog seals		✓	-
Crack seal	Selective	-	✓
Crack fill		-	✓
Joint seal		-	✓
Patching		-	✓
Partial-depth concrete repair		-	✓
Full-depth concrete repair		-	✓
Edge repair		-	✓
Diamond grinding		-	✓
Dowel bar retrofit	✓	-	
* Activities may include the use of mechanical improvements such as geotextiles or geogrids			

Throughout this document, where appropriate, activities will be referred to as 'total' and 'selective' treatments as detailed in the table.

### 1.5. Quality Management

Quality management is the coordination of activities to direct and control an organization with regard to quality. A quality management system is used to guide this process and, in the case of pavement preservation test sections, refers to Caltrans' structure for managing its processes and activities that transform inputs of resources into a product or service which meet the organization's objectives, namely ensuring consistently designed and tested experiments that provide good quality data that can be used with confidence to develop and implement procedures to improve delivery of infrastructure in California.

Where there is employee turnover, the quality management system and its associated documentation is an aid to continuity of operations. It assists in managing operations based on procedures and not people and helps to prevent unacceptable changes in practice that may occur as a result of changes in personnel.

Quality management encompasses a number of key components.

### 1.5.1 Caltrans Project Delivery Quality Management Plan

The Caltrans Project Delivery Quality Management Plan (QM) was established to implement and document a fully integrated project delivery "Quality System" that would be applied to all transportation projects regardless of funding source, sponsorship, or who performs the work. This plan focuses on the delivery of Quality Transportation Projects, emphasizing accountability and utilizing continuous improvements, to assist the Department in achieving its mission to "Improve mobility across California".

#### Quality Management (QM)

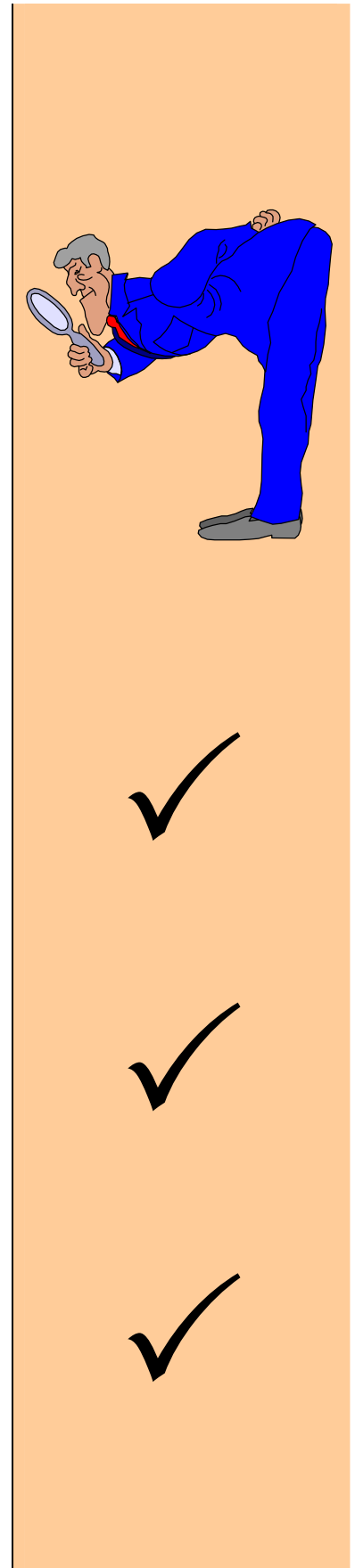
Quality management consists of discrete activities that establish the quality objectives, policy, and responsibilities; and implements these responsibilities with the aid of Program Reviews (PR), Independent Assurance (IA), Quality Assurance (QA), Quality Control (QC), and continuous improvement within each of these activities.

#### Program Review (PR)

Program review includes those activities that establish the objectives and requirements for quality, based on program level evaluations of trends and performance measures. Program Review should cause validation, modification, or redirection of business practices related to project delivery.

#### Independent Assurance (IA)

Independent assurance are those activities performed at the corporate level (Division Chiefs and District Directors) to help assure that quality management practices are in place, functioning, and effective. Independent Assurance should cause continuous improvement in policies and procedures related to project delivery.



# QC

## **Example**

*1<sup>st</sup> level data checks by another team member after monitoring*

# QA

## **Example**

*Establishment of an evaluator training and calibration procedure to ensure consistency in evaluations*

## Quality Control (QC)

Quality Control refers to the operational processes, practices and activities performed by the project team during the project delivery process. It is used to verify that deliverables are of acceptable quality and that they meet the completeness and correctness criteria established in the quality planning process. Quality Control is conducted continually throughout a project and is the responsibility of team members and the project manager.

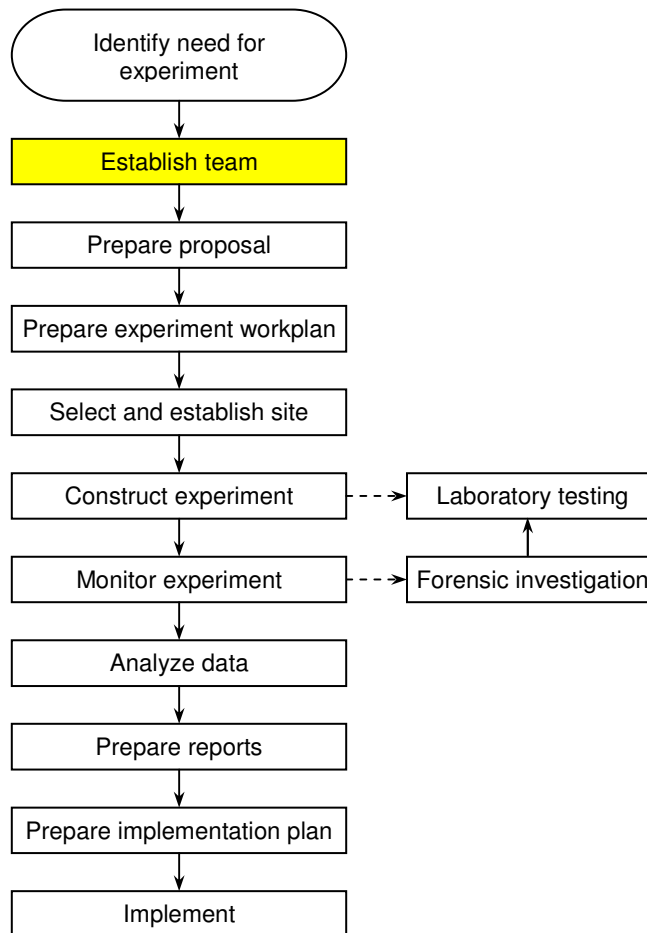
## Quality Assurance (QA)

Quality Assurance does not refer directly to the specific deliverables themselves but rather to the process used to create the deliverables. In general, quality assurance activities focus on the processes used to manage and deliver the solution, and can be performed by a manager, client or a third-party reviewer. For instance, an independent project reviewer might not be able to tell if the content of a specific deliverable is acceptable. However, they should be able to tell if the deliverable seems acceptable based on the process used to create it. They can determine, for instance, whether reviews were performed, whether it was tested adequately, whether the client approved the work, etc.

Quality assurance includes activities performed at the district management (functional management) level, during the project delivery process. They provide the confidence that the project team is fulfilling established project requirements and expectations.

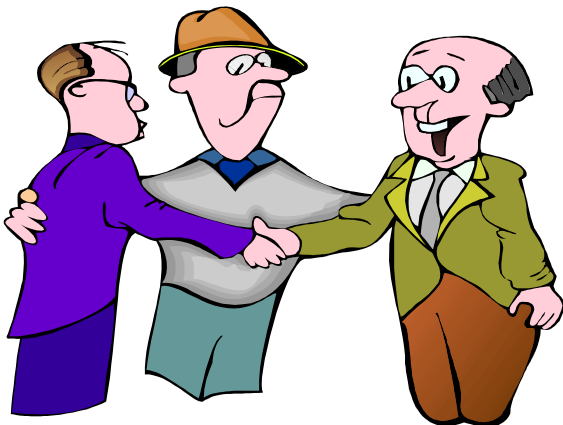
## 2. MANAGEMENT AND RESPONSIBILITIES

---



### 2.1. Introduction

A team of suitably qualified and experienced personnel is required to manage, establish and evaluate pavement preservation experiments in close liaison with other units who have responsibility for the road. This team will be accountable for optimizing the establishment and evaluation of pavement preservation experiments and presentation of the highest quality data possible in a format that is useable by other Divisions within Caltrans. The establishment and evaluation of experiments is expensive. Outcomes may result in state-wide changes to current practice and specifications and implementation might be scrutinized by many individuals within the state,

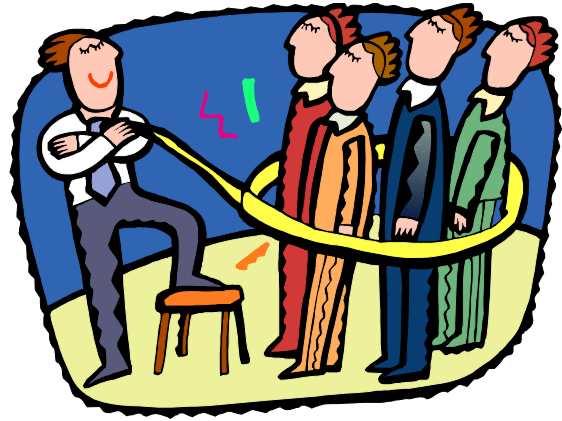




as well as nationally and internationally. Roles and responsibilities thus need to be clearly defined and monitored by means of appropriate job descriptions, key-result areas and performance evaluation.

## 2.2. Staffing

The success of each pavement preservation experiment is directly dependent on the individuals that develop the experiment plan, establish the section, do the evaluations, undertake laboratory tests, and collect, store and analyze the data. The roles and responsibilities of each position in the team thus need to be clearly defined to ensure that relevant positions in the team are accountable for the actions required to effectively deliver each part of the project. It is important to ensure that positions, and job descriptions for those positions, are not created around individuals, but rather to achieve optimal functionality. This will ensure continuity and sustainability of an experiment when staff changes occur - an important issue given the long-term nature of many experiments.



Depending on a particular project, one person may undertake more than one role, but must then accept responsibility for each. Positions will usually form part of a larger job description (e.g., the District Materials Engineer may also be the Project Engineer for a pavement preservation experiment).

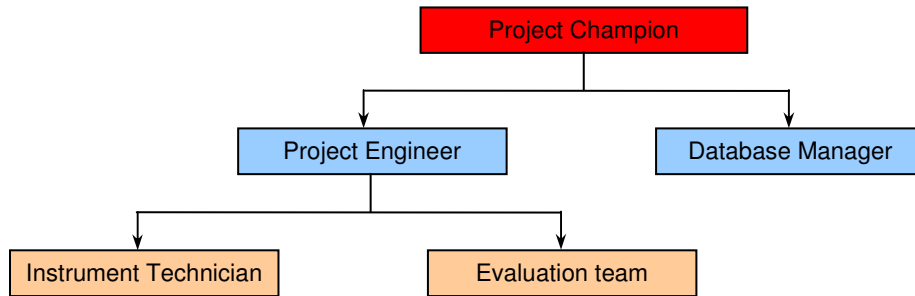
In the event of staff changes, the project champion will need to ensure that the new staff member assumes the responsibilities of the job description, including those linked to pavement preservation experiments. The job description should be sufficiently comprehensive to ensure that the new incumbent is aware of his/her responsibilities and can accomplish them once adequate training has been carried out.

Typical staffing requirements associated with pavement preservation experiments include the following:

- Project Champion
- Project Engineer/Project Manager
- Database Manager
- Instrumentation Technician
- Evaluation Team

Certain functions could be carried out by the same person, and the positions are unlikely to be full-time

The recommended staffing structure is illustrated in Figure 2.1.



**Figure 2.1: Typical staff organization chart for pavement preservation experiments**

The job descriptions for those positions that are involved with the experiment should be modified to include the additional duties, in line with Caltrans requirements, each with clearly defined roles and responsibilities. Each modification/appointment should be accepted in writing by the appointee and filed with his/her employment documentation. Thereafter the individual should be held accountable for those responsibilities and performance should be rated on achievements related to them.

### **2.2.1 Project Champion**

The Project Champion is typically the Maintenance Engineer. Although this individual may not have initiated the research (i.e., the Project Proposer), he/she will have overall responsibility for the experiment. These responsibilities include:

- Liaison with other interested and affected divisions and offices within Caltrans
- Overall program management and accountability
- Securing sustainable funding to complete the study
- Strategy development and review
- Project identification in line with the strategy
- Delegation of authority to the Project Engineer
- Project Experiment Work Plan approval
- Quality management of outputs
- Industry liaison, coordination feedback and implementation

The Project Champion may also establish a panel consisting of the proposer, experts in the treatments of processes being assessed, and industry, for some of these duties.

### **2.2.2 Project Engineer/Project Manager**

The Project Engineer is often, but not necessarily, the initiator or proposer of the experiment. He/she is responsible for overall project management, compiling the Experiment Work Plan and then ensuring that it is correctly implemented. If a new product is being assessed, the project Engineer shall follow the guidelines for new product evaluation. He/she will coordinate and lead evaluations and laboratory testing

ensuring that appropriate evaluations and testing are being carried out to meet the objectives of the Experiment Work Plan. He/she will discuss the need for changes to the Experiment Work Plan and will be responsible for preparing the first-level report for the test. Involvement in second level analysis and reporting may also be required and will depend on the investigation. This individual reports to the Project Champion and his/her job description and key result areas should accommodate the following responsibilities for which he/she should be held accountable and evaluated against:

- Liaison with the Project Champion on all aspects pertaining to the experiment(s)
- Liaison with product/technology providers if applicable.
- Maintain a Project File in which all documentation relevant to the experiment is stored
- Preparation of Experiment Work Plans, project experiment designs and project specifications
- Management of and delegation of authority to the Instrumentation Technician and Evaluation Team
- Site location
- Layout of the experiment
- Test and control section construction
- Supervision of instrument installation and calibration
- Coordination of associated laboratory testing and control sample storage
- Training and calibration of evaluators
- Evaluations
- Liaison with the Database Manager to ensure that data is useable, in the correct format, and distributed to the required individuals
- Data validation, first level analysis of results and reporting

### **2.2.3 Database Manager**

The Database Manager should report to the Project Champion and should have the following responsibilities for which he/she should be held accountable:

- Provide input to the project Experiment Work Plan in terms of data formats, database requirements and naming and numbering conventions
- Establish a database architecture to suit the Experiment Work Plan for each project
- Remind the Project Engineer of scheduled monitoring visits
- Liaise with the Project Engineer and Laboratory Manager to ensure timely and accurate capture of data into the database
- Quality checks on all data
- Maintain the database including links to Experiment Work Plans and reports, backups and updating of all files and all backups to the latest software versions
- Ensure that all data files are appropriately stored and that raw data is never altered
- Ensure that a backup is made of the Project Engineers relevant hard drive files on completion of each project and stored together with other files from the project

- Facilitate report printing and distribution in suitable formats
- Ensure long-term availability and accessibility of all records in the database
- Establish and maintain an archive of all reports and documents prepared on pavement preservation experiments within the office of the Chief of Pavement Preservation

#### **2.2.4 Instrumentation Technician**

If test sections are instrumented, an Instrumentation Technician may need to be appointed. This individual will report to the Project Engineer and his/her job description and key result areas should accommodate the following responsibilities for which he/she should be held accountable:

- Instrument installation and calibration
- Training of assistants
- Ensuring that a sufficient inventory of instrument components and consumables is maintained and that orders for replacement are placed in a timely way.

#### **2.2.5 Evaluation Team**

The Evaluation Team is led by the Project Engineer and should have the following responsibilities:

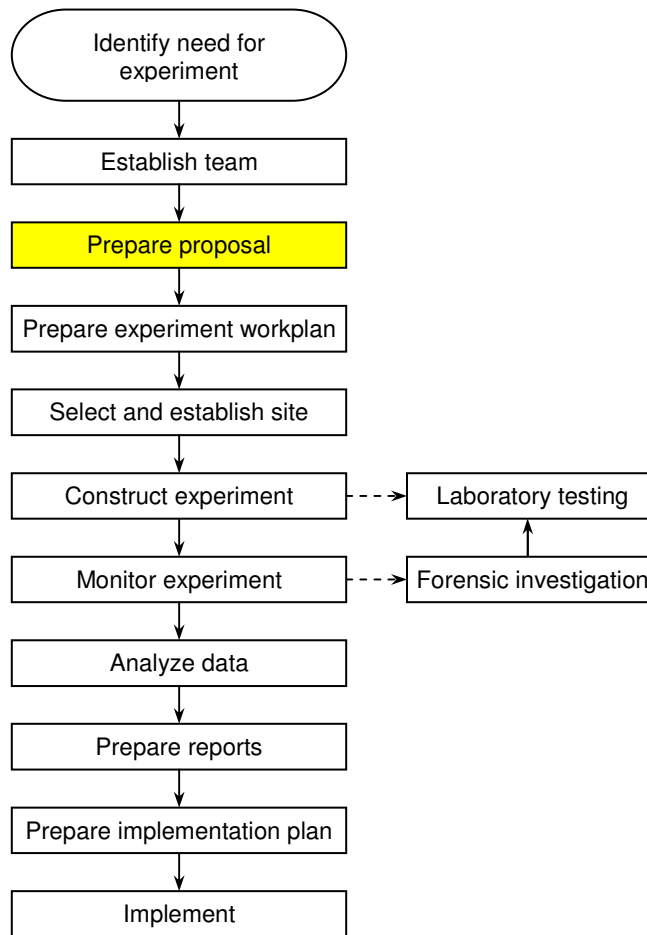
- Evaluation of the experiment(s) according to the requirements of the Experiment Work Plan
- Submission of data to the database manager
- Assistance to the Project Engineer with first level analysis





### 3. PROJECT FUNDAMENTALS

---



#### 3.1. Introduction

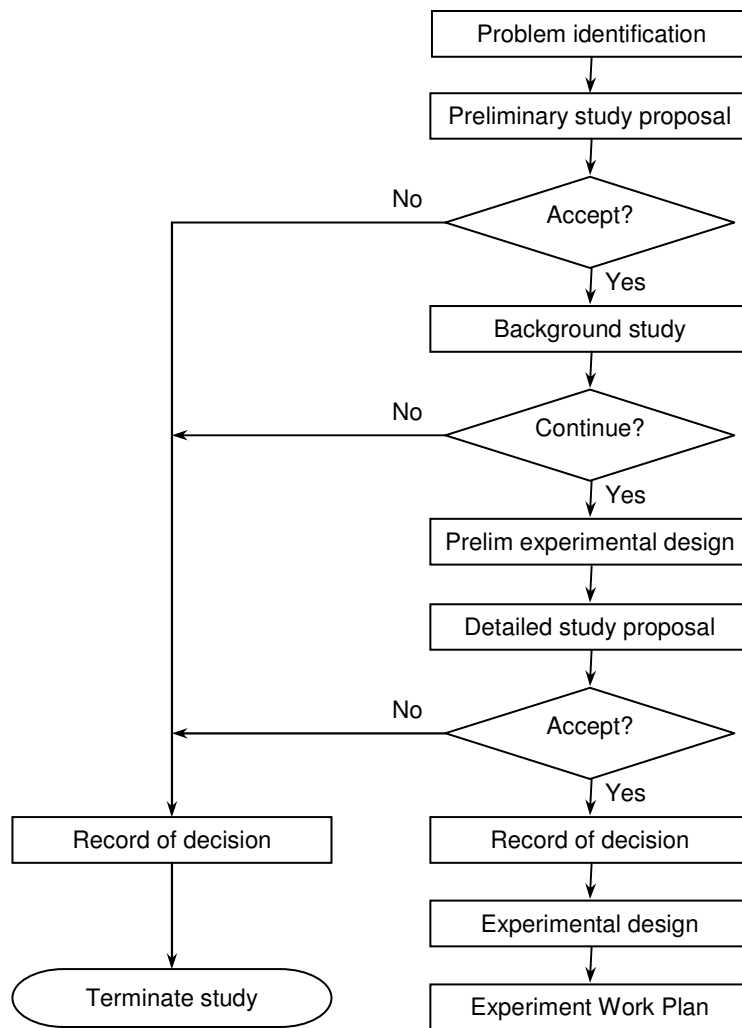
The project fundamentals revolve around the need to do the experiment and the implications of



implementing the findings. Pavement preservation experiments are built for a variety of reasons, primarily to understand the behavior, performance and potential benefits of doing something new or differently. However, experience has shown that in many instances, the objectives for constructing an experiment are often not fully thought out, insufficient background study is carried out, inappropriate data is collected, monitoring programs and protocols are not

adhered to, the results are not written up, and the findings are not implemented. Therefore, it is imperative that the reason for initiating the experiment is fully understood and that a comprehensive

experimental design is prepared in order to ensure that the objectives are met and, if successful, the procedure being evaluated can be adopted as standard practice, where appropriate, with confidence. Someone also needs to take and maintain overall responsibility throughout the life of the experiment, which includes handing it over to another individual if that person moves within the organization, or leaves. In this chapter, study proposals, background studies and experimental designs are introduced. A flow chart depicting the processes covered in this chapter is provided in Figure 3.1.



**Figure 3.1: Flowchart for project approval**

### 3.2. Study Proposals

Study proposals are considered in two phases by Caltrans - pre-proposal and full proposal. A summary of a process proposed by Caltrans Division of Maintenance, Office of Pavement Preservation, is provided in Appendix A, with full details on meeting the requirements provided in the following chapters. The pre-

proposal, discussed below, is essentially submitted as a justification to undertake the study. The full proposal provides more detail and is submitted after additional work has been carried out.

### 3.2.1 Pre-Proposal

The pre-proposal should be prepared as the first step in the process and should include the following:

- Project title
- Project Proposer and Project Champion and their contact information
- A purpose definition in the form of a problem statement or hypothesis, for example:
  - “Evaluate the performance of proprietary grids for preventing reflective cracking in thin overlays” or “Pothole filler ‘A’ is better than Pothole filler ‘B’”
- Details on the proposed process or innovation including:
  - Description
  - Patent information if applicable
  - Conditions under which it has been designed to perform. Distress conditions should be consistent with descriptions in the Maintenance Technical Advisory Guide (MTAG) and/or Caltrans Pavement Condition Survey Manual.
  - Selection criteria used to determine where the process or innovation can be used
  - Specifications including design and construction/application
  - Information on where it has been used, including field performance data
- Reasons and justification for undertaking the study
- Potential benefits of the study, both monetary and operational

Pre-proposals should be approved by the Pavement Preservation Task Group Chair and, if a new product is being considered, the New Products Coordinator. Once approved, a background study should be undertaken to gather sufficient information on which to base a decision on proceeding with or halting a study.

### 3.2.2 Background Study

Before embarking on a detailed research study and construction of experiments that could be both expensive and time consuming, the proponent should carry out a background study to see if similar studies have been carried out elsewhere in the state, in the country or internationally. The study can be done through Caltrans libraries and on the Internet (e.g., Google search and Google Scholar search). A detailed literature review, interviews and even some pilot laboratory testing may be required before a decision is made to continue with the study. A brief state-of-the-art report should be prepared on completion of this phase summarizing:

- Overview of why the study is being undertaken and the potential benefits to Caltrans





- Findings of the literature review, including:
  - Details on any similar research that has been carried out
  - The reasons why the practitioners undertook the study
  - Status of the study
  - How the findings were implemented and what the implications were
- Results from the preliminary laboratory study if undertaken
- Applicability of the findings to California
- Justification to continue or discontinue the study
- Proposed experimental design

The justification to continue with a study would typically be based on the following (see Figure 3.2 and Checklist 1 in Appendix B):

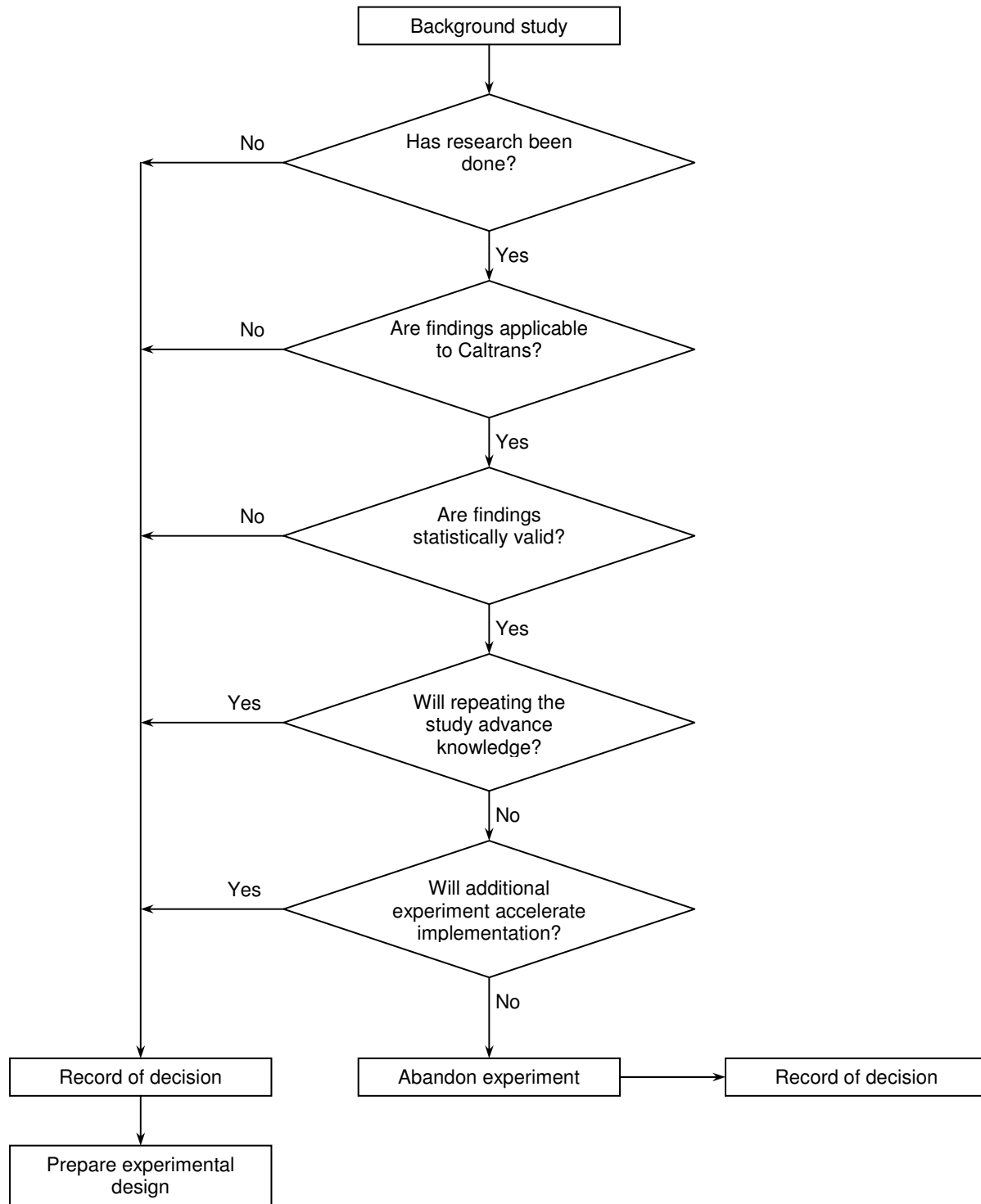
- No similar work had been carried out elsewhere
- The findings were not applicable to California (e.g., different materials or climate)
- The research was not carried out in a scientific manner such that statistically valid results were obtained
- The experiment could be considered as a replicate of the previous experiment with data being used to enhance the analysis and reliability of the findings
- The experiment could be considered as another cell in the experimental design covering a specific aspect (e.g., environmental or traffic) not covered in the previous experiment

### **3.2.3 Full Proposal**

A full proposal should be prepared after completion of the background study. This proposal should include the content from the pre-proposal and background information documents, as well as:

- Potential partners (those who have a vested interest in the results and who could make technical, financial or “in-kind” contributions)
- Project logistics, including:
  - Potential locations for the experiment
  - Estimated project costs
  - Potential problems, impacts and remedies
  - Warranties
  - Safety and environment, including any material safety data sheets (MSDS), safety forms received from the product suppliers and any additional safety and environmental issues that need to be addressed
- Proposed work plan (see Chapter 4) and timetable
- Estimated study budget
- Definition of success, including the performance and cost criteria that will define success compared to current Caltrans practice.

- Details on how the findings would be implemented including expected deliverables, who would lead the implementation process and probable timetable and cost
- Signed commitment by the project team to complete the study



**Figure 3.2: Flowchart for background study**

A decision to proceed with the experiment should be made by the Project Champion after review of the background study report and full proposal. A record of decision should be documented. A checklist for preparing/reviewing proposals is provided in Appendix B (Checklist 2). Once approved, details on the experiment should be added to a central register of experiment proposals, maintained by the Chief of the Office of Pavement Preservation. The experiment register is discussed in Chapter 11. A project file should be opened by the Project Engineer and a copy of the approved proposal filed together with any other relevant documentation. Copies of the Project File should be kept by the Project Champion, Database Manager and any other individuals involved in the study who will need access to relevant information.

### 3.3. Experimental Design



The experimental design is a fundamental component of the Experiment Work Plan, which is discussed in the following chapter. Sufficient time and effort should always be given to organizing the experiment properly to ensure that the right type of data, and enough of it, is available to answer the questions of interest as clearly and efficiently as possible. This process is called experimental design.

The specific questions that the experiment is intended to answer must be clearly identified together with known or expected sources of variability in the experimental units. One of the main aims of a designed experiment is to reduce the effect of these sources of variability on the answers to questions of interest. That is, the experiment should be designed in order to improve the accuracy and precision of the answers.

The experimental design is a basic plan of how the study/experiment will be carried out in order to draw a valid conclusion. It should consider all relevant dependent and independent variables and should be sufficiently comprehensive such that a statistically valid conclusion is arrived at. Where appropriate, the experimental design should not be restricted to single experiments and instances, and replicates and variables should be considered to ensure that the results are applicable throughout the state or that the limitations of the procedure, technology or product are fully understood such that it is not implemented where it will not perform satisfactorily.

#### 3.3.1 Terminology

The following terminology is commonly used in the preparation of experimental designs:

- **Treatments** - In experiments, a treatment is something that researchers 'administer' (e.g., the comparison of different chip seals to assess which has the least stone loss after opening to traffic). Treatments are usually divided into 'levels', where level is either a categorical variable (e.g., Binder A, B and C) and/or an amount or magnitude (e.g., different binder spray rates or temperatures).

- **Factor** - A factor of an experiment is a controlled independent variable; a variable whose levels are set by the experimenter. A factor is a general type or category of treatments. Different treatments constitute different levels of a factor (e.g., three different binder types are applied at different temperatures. The binders are the experimental units and the application temperatures are the treatments, where three different temperatures constitute three levels of the factor 'type of binder'). Typical factors that may be considered in an experimental design include, but are not limited to:
  - Traffic and type of vehicle
  - Environment (weather, subgrade conditions, water table, etc.)
  - Materials
  - Type of pavement
  - Geometry and slope
  - Construction factors (e.g., binder temperature, compaction equipment)
  - Laboratory test methods that can be correlated with field performance
- **Factorial Design** - A factorial design is used to evaluate two or more factors simultaneously. The treatments are combinations of levels of the factors (e.g., three binder types, applied at two different temperatures, in three different climatic zones at two different traffic levels [total of 36 sections]). The advantage of factorial designs over one-factor-at-a-time experiments is that they are more efficient and they allow interactions to be detected. Factorial designs are commonly used in road experiments.
- **One Way Analysis of Variance** - is the comparison of several groups of observations, all of which are independent but possibly with a different mean for each group. A test of great importance is whether or not all the means are equal. The observations all arise from one of several different groups (or have been exposed to one of several different treatments in an experiment). 'One-way' is classified according to the group or treatment.
- **Two Way Analysis of Variance** - is a way of studying the effects of two factors separately (their main effects) and (sometimes) together (their interaction effect).
- **Completely Randomized Design** - the structure of the experiment in a completely randomized design is assumed to be such that the treatments are allocated to the experimental units completely at random.
- **Randomized Complete Block Design** - is a design in which the subjects are matched according to a variable which the experimenter wishes to control. The subjects are put into groups (blocks) of the same size as the number of treatments. The members of each block are then randomly assigned to different treatment groups. (e.g., A researcher is carrying out a study of the effectiveness of four different crack sealants. He/she has 100 cracks on which to assess the sealants and plans to divide them into four treatment groups of 25 cracks each. Using a randomized block design, the cracks are assessed and put into blocks of four according to width; the four widest cracks are the first block, the next four widest are the second block, and so on to the 25th block.

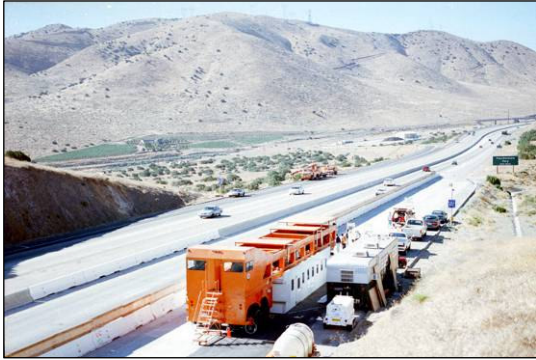
The four cracks of each block are then randomly assigned, one to each of the four treatment groups).

- **Main Effect and Interaction Effect** - the main effect is the simple effect of a factor on a dependent variable. It is the effect of the factor alone averaged across the levels of other factors. (e.g., the results of experiments indicate that two different fog seals and one chip seal were all effective in extending the life of a pavement surfacing (main effect of fog seal and main effect of chip seal). When fog seals and chips seals are considered in combination; the two fog seals might have worked equally well (main effect of fog seal); fog seal A and a later chip seal showed the benefits of both (main effect of fog seal A and main effect of chip seal). However, it might have been found that the use of fog seal B, followed by a later chip seal showed the benefits of both plus a 'bonus', such as significantly extended life of the chip seal, known as an interaction effect (main effect of fog seal B, main effect of chip seal plus an interaction effect).
- **Interaction** - is the variation among the differences between means for different levels of one factor over different levels of the other factor.
- **Randomization** - is the process by which experimental units (the basic objects upon which the study or experiment is carried out) are allocated to treatments; that is, by a random process and not by any subjective and hence possibly biased approach. The treatments should be allocated to units in such a way that each treatment is equally likely to be applied to each unit. Randomization is preferred since alternatives may lead to biased results. It tends to produce groups for study that are comparable in unknown as well as known factors likely to influence the outcome, apart from the actual treatment under study. The analysis of variance F tests assume that treatments have been applied randomly.
- **Control** - is a 'do nothing' or a standard treatment to which the performance is compared (e.g., an experiment to assess the ability of grids to reduce cracking must include a control where no grid is used, built to exactly the same specifications, but excluding the grid).
- **Replicate** - is a repetition of an experiment to quantify the influence of factors such as variability in materials, construction procedures, climate, traffic, etc. Replicates can be constructed at the same site (e.g., to assess variability in materials) and/or at different sites (e.g., to assess influence of climate or traffic). Replicates improve the statistical validity of the experiment, but are often overlooked in the experimental design.

### 3.3.2 Types of Experiment

Pavement preservation experiments can take many forms, including but not limited to one or a combination of the following:

- Assessing a new strategy/treatment/technology (i.e., does this technology "work"?)
- Comparing one strategy/treatment/technology with another (i.e., which is the "best" treatment?)
- Refining a strategy/treatment/technology (i.e., what is the "best way" to do this treatment?)
- Understanding a treatment/technology (i.e., "how" does this technology work?)



They will typically involve both laboratory and field experiments. Testing may be phased, beginning with laboratory tests that will screen a comprehensive experimental design, followed by accelerated pavement testing (Heavy Vehicle Simulator (HVS)), if appropriate, on a refined (reduced) experimental design, and then completed with full-scale field (pilot) experiments where an even more refined experimental design is assessed. The first two phases will provide confidence for the engineers to test under actual traffic and environmental

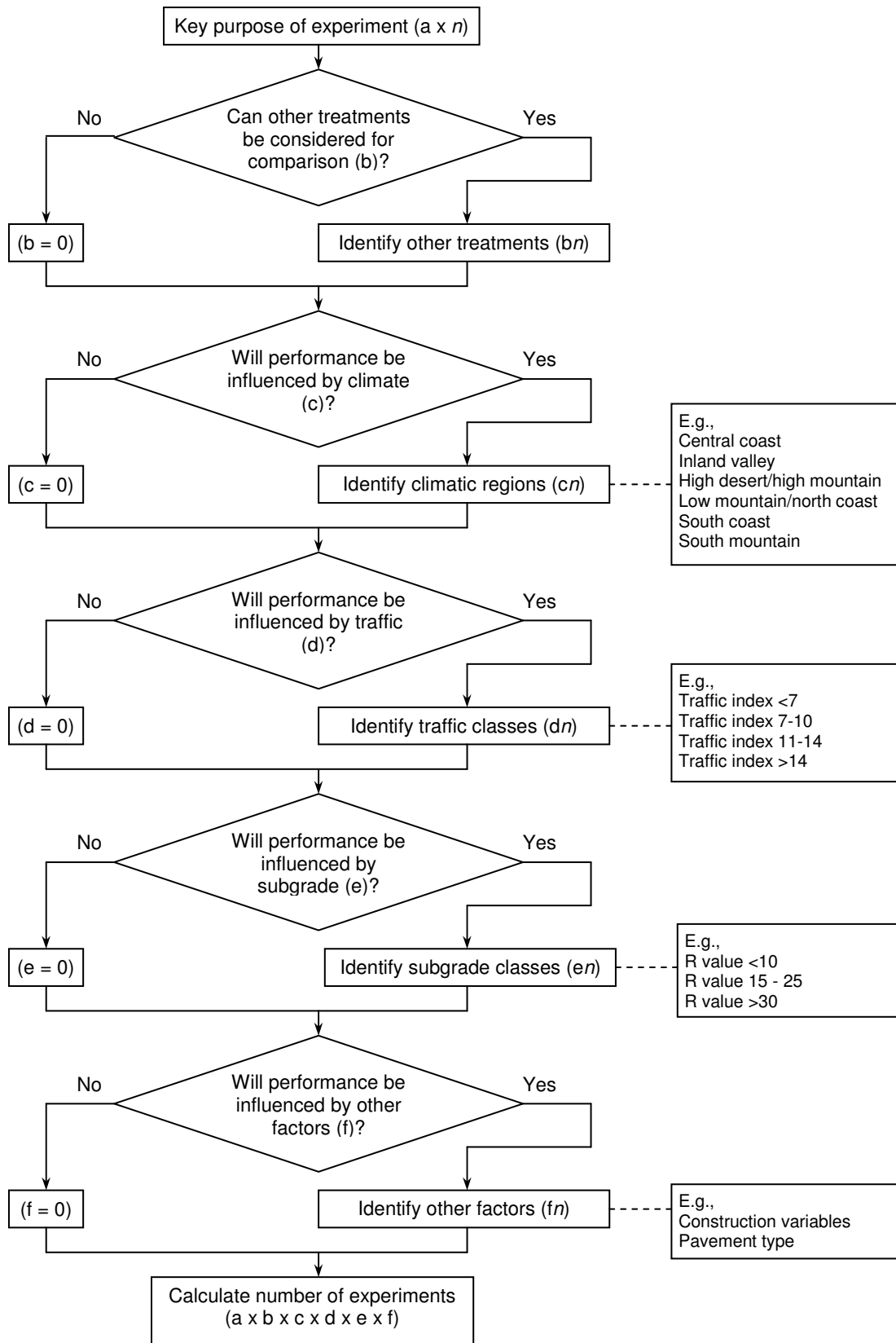
conditions. Laboratory testing is relatively inexpensive and is used as a screen. Accelerated pavement testing is considerably more expensive than laboratory testing, but still much cheaper than field studies. It should be noted that accelerated pavement testing with the HVS is only appropriate for assessing the effects of load and cannot be used for assessing the effects of speed, wheel turning and dynamic loading, or environmental factors such as aging, diurnal temperature changes and wet and dry seasons.

For example, in an assessment of thin maintenance overlays using modified binders, the performance of all possible binder and aggregate combinations can be tested in a laboratory using fatigue beam and shear tests. The best performing combinations can then be subjected to accelerated pavement testing, which will provide an indication of which combinations can be tested in full-scale pilot studies with confidence.

### **3.3.3 Factorial Experimental Designs**

As mentioned above, factorial experimental designs are often used in pavement preservation experiments. Care must be taken in deciding on the factors that will be assessed in order to keep the experiment focused and manageable. It should be remembered that the addition of a factor will result in an exponential increase in the number of cells in the factorial design. For example, assume an experiment to compare two modified binders with a conventional binder in a chip seal application is proposed. This will require three test sections for a basic experiment without a replicate. If performance is considered to be influenced by traffic, and three different traffic levels are considered, the factorial increases to 3x3 cells or nine sections (typically at three different locations). If application temperature is also raised as an issue and two different temperatures are considered, the factorial increases to 3x3x2 or 18 sections, and so on. Partial factorial experiments are often used where not all cells are assessed, but instead a selection is tested to identify trends. Unrealistic combinations can also be eliminated to reduce the number of sections.

A flow chart depicting the factorial experimental design decision process is shown in Figure 3.3.



**Figure 3.3: Flowchart for factorial experimental design**

An example layout of a factorial experimental design for an assessment of chip seals is shown in Table 3.1. The control would typically be standard practice and Seals 1-3 would, for example, be:

- A tighter grading (e.g., <5 percent material larger or smaller than nominal aggregate size) with standard binder
- A rubber modified binder with standard grading
- A tighter grading with rubber modified binder

**Table 3.1: Example layout of factorial experimental design**

Climate	Traffic	Pavement condition	Surface treatment			
			Control	Seal 1	Seal 2	Seal 3
Coastal	Low	Good				
		Poor				
	High	Good				
		Poor				
Valley	Low	Good				
		Poor				
	High	Good				
		Poor				
Mountain	Low	Good				
		Poor				
	High	Good				
		Poor				

### 3.3.4 Replicate Studies

Replicate studies are important in many types of experiment, especially where variables (construction, material variability, weather) can influence performance of the treatment being assessed. The inclusion of replicates will improve the reliability of the findings. Two types of replicate need to be considered:

- Replications within the same test section, typically used to deal with construction, material, and/or pavement variability within the test section.
- Replications between other regions, materials, pavement types, climates and/or traffic, etc. in the state to identify boundaries to implementation, if these are not already being considered as factors in the experimental design.

Replications are often overlooked as they are considered to be too expensive. However, experience has shown that if sufficient replicates are not built and assessed, satisfactory implementation is rarely achieved as engineers are resistant to apply new technologies that were not proven under their specific conditions. Replicates can be considered as part of the factorial experimental design as depicted in Figure 3.3.

### 3.3.5 Evaluation Criteria

Key evaluation criteria, on which the success of the treatment will be decided, need to be established for each experiment. These should be linked to the experiment objective. For example, if two modified



binders are being compared in a chip seal experiment, the key evaluation criteria will probably be raveling/stone loss over time. Evaluation criteria are discussed in more detail in Chapter 7.

### 3.3.6 Failure Criteria



In any experiment, it is important to establish and understand what the failure criteria for any experiment are and what action needs to be taken when failure occurs. Examples of failure criteria include rut depth, stone loss and length or area of cracking.

It should be remembered that most learning with regard to pavement performance and behavior will be derived from understanding the failure mechanism. It is thus preferable to design experiments in such a way that failure will occur on certain sections. Researchers should be encouraged to adopt this line of thinking and to avoid only designing experiments that do not 'fail'. Care will need to be taken when selecting experiment locations to ensure that road users are not endangered and that maintenance or rehabilitation of the section can be rapidly undertaken without major disruption to traffic.

### 3.3.7 Experiment Completion

The criteria for deciding when an experiment is completed should also be determined in the experimental design. This will be the point at which sufficient data has been collected such that an informed decision can be made on whether to adopt/proceed with implementation or reject the strategy/treatment/technology. It could be time (e.g., level of performance after a period of elapsed time) or performance based (e.g., no improvement over control in terms of performance indicators).

## 3.4. Quality Management



Quality management issues pertaining to the roles and responsibilities described in this chapter include:

- Preparation of study proposals
- Completion of a background study to determine whether the research has already been undertaken and/or is relevant to California
- Consideration of an experimental design that will provide sufficient data such that statistically valid conclusions can be drawn with respect to the objectives of the study
- Approval of the preliminary project proposal, background study and detailed proposal by the Project Champion

- Approval by the Pavement Preservation Task Group Chair in line with the Caltrans Innovation Process
- Documentation of all records of decision
- Opening a central Project File containing all documentation relevant to the study

### **3.4.1 Documentation Management**

At the beginning of any experiment, a Project File should be opened by the Project Proposer. All documentation associated with the study should be kept in this file. Copies of relevant documents should be sent to the project team. Once a proposal has been approved and a project team assembled, the Project Engineer (often also the Project Proposer) should assume responsibility for the Project File in his/her capacity as Project Manager.

A register of all project proposals should be centrally maintained, together with a record of decision on whether to proceed or not. This will limit unnecessary duplication of research.

### **3.4.2 Responsibility**

The Project Engineer is responsible for:

- Preparing and submitting the project proposals
- Undertaking or delegating someone to undertake the background study
- Writing the background study report
- Opening and maintaining a Project File
- Distributing copies of relevant documents to the project team

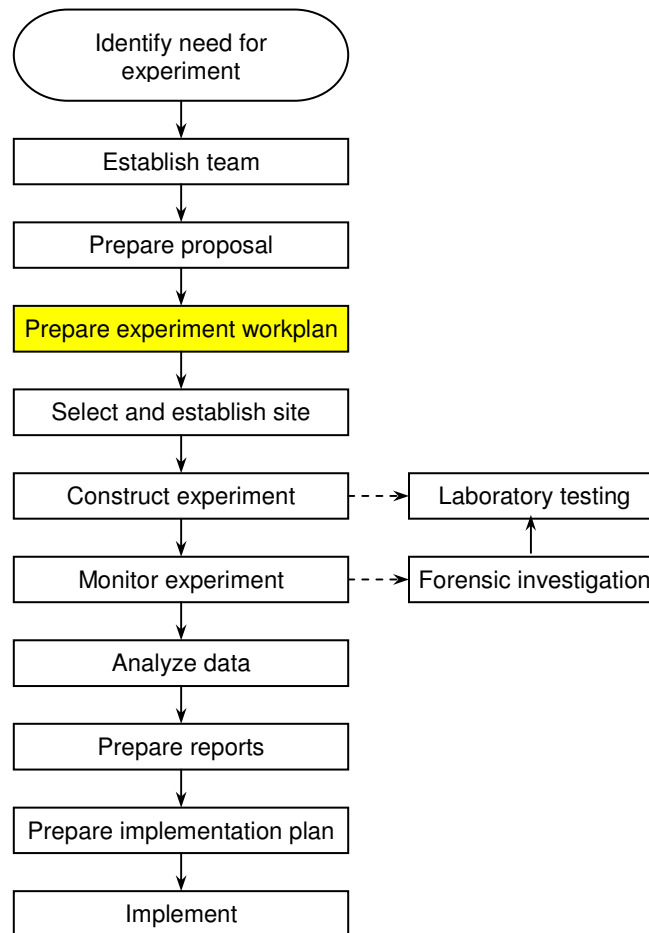
The Project Champion is responsible for:

- Guiding the proposals through the Innovation Process
- If a phased approach is followed, approving the background study
- Deciding on whether to proceed with the full study in collaboration with the Pavement Preservation Task Group Chair
- Completing a record of decision
- Updating the central experiment register in the Office of Pavement Preservation (see Chapter 11).



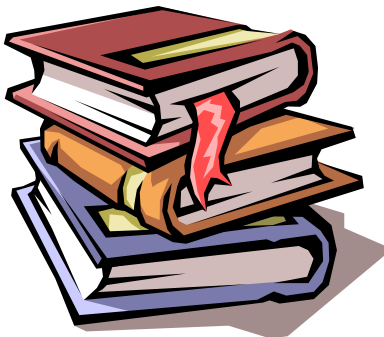
## 4. EXPERIMENT WORK PLAN

---

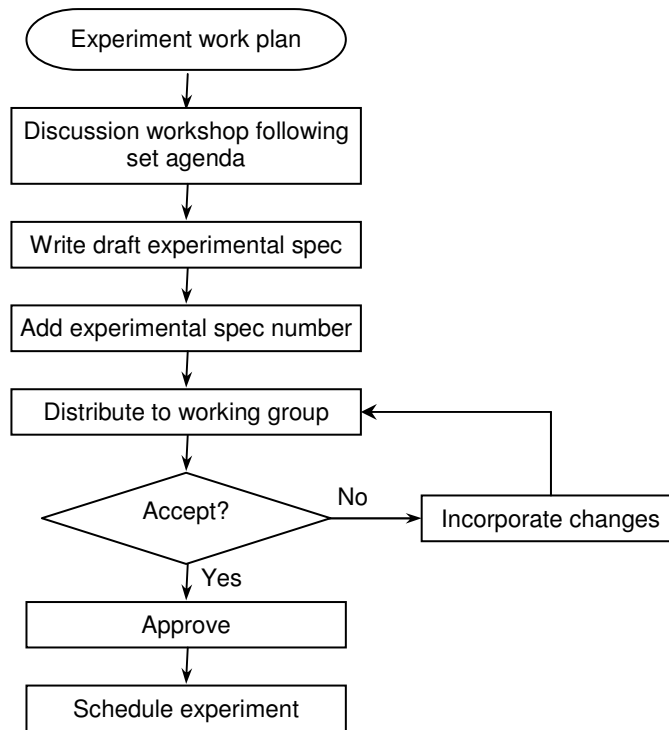


### 4.1. Introduction

The Experiment Work Plan is a comprehensive document detailing the objectives of the experiment, the experimental design, the control, evaluation procedures, and responsible persons. It should be considered a “live” document in that changes during the course of the experiment are often necessitated. An Experiment Work Plan must be prepared for every experiment once the decision to proceed with an experiment is made by the Project Champion and Pavement Preservation Task Group Chair after completion and review of the background study and detailed proposals (see Appendix A).



In this chapter, the procedure for preparing an experiment work plan, the work plan content and format and revisions to the work plan are discussed. A flow chart of the process covered in this chapter is provided in Figure 4.1.



**Figure 4.1: Flowchart for development of an experiment work plan**

## 4.2. Procedure

The preparation of an Experiment Work plan involves four main stages:

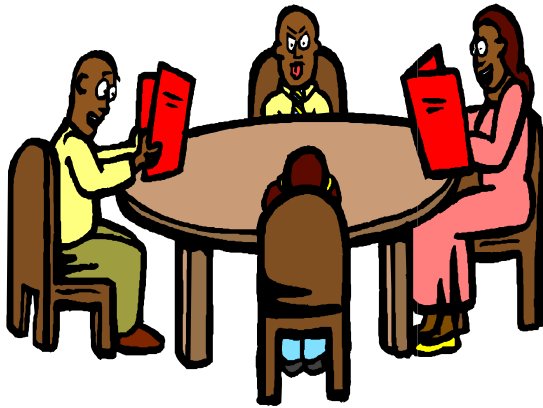
- Project planning meeting
- Work plan write up
- Work plan review
- Work plan approval

### 4.2.1 Project Planning Meeting

The project planning meeting is held to agree on the test objective and to formulate a framework for the test such that appropriate data will be collected.

The following individuals should participate:

- Project Champion
- Project Engineer
- Database Manager
- District Engineer(s) and maintenance staff from the districts in which the experiments are planned
- Other interested parties, for example, suppliers of products that are being evaluated, and contractors who will be undertaking the work



The agenda for the project planning meeting should include:

- Objective of the experiment
- Implications of the findings from the background study
- Experimental design to meet the test objective
- Control experiment for comparative purposes
- Experiment location
- Construction requirements
- Instrumentation and equipment required to provide data for envisaged outcome
- Monitoring program
- Monitoring procedure
- Failure and experiment completion criteria
- Associated laboratory experiments
- Data collection, validation and storage
  - Frequency of data collection
  - Data validation (visual, comparison with previous measurement, within predefined parameters)
  - Data transfer to Database Manager (timing, medium)
- Reports
- Criteria to be met for strategy/treatment/technology/procedure/product to be adopted as standard practice
- Implementation plan if successful
- Repairs to road after testing
- Other

The Project Engineer should facilitate the project planning meeting and minute the discussion. These minutes will be used to prepare the Experiment Work Plan.

The above agenda framework should be used as a checklist to ensure that all relevant issues are discussed and that a satisfactory outcome has been recorded for each. A copy of the agenda in checklist form is provided in Appendix B (Checklist 3).

#### **4.2.2 Work Plan Write-Up**

The Project Engineer should write the Experiment Work Plan based on the agreements reached at the project planning meeting. Although each Experiment Work Plan will differ according to the objective, a generic content and table of contents should be adhered to, to ensure that all relevant issues are documented. Guidelines for content and table of contents are provided in the following sections.

Responsibilities for preparing the Experiment Work Plan include those of the:

- **Project Champion** - responsible for ensuring that the test objectives are aligned with Caltrans policy and procedures
- **Project Engineer** - responsible for preparing the Experiment Work Plan and liaising with the team members
- **Database Manager** - responsible for providing information on data collected from past experiments with which the proposed experiment may be compared, naming and numbering conventions, formats, data transfer, database design and population and data and report archiving

#### **4.2.3 Work Plan Review**

The draft Experiment Work Plan should be reviewed by the project planning meeting attendees. The review should focus on technical content and correctness only. Fundamental changes to what was agreed upon at the meeting should not be made. The Project Engineer should coordinate the review process and is responsible for setting deadlines for comments, receiving comments, discussing changes with the team members and revising the document.

#### **4.2.4 Approval**

The final Experiment Work Plan should be approved with the following signatures:

- Project Champion
- Project Engineer
- Database Manager
- District Engineer(s)

### **4.3. Experiment Work Plan Content**

The following information should be included in the Experiment Work Plan. Details on each component are discussed in more detail in later chapters.

- Objective of the test
- Staffing and contact details
- Responsibility and reporting matrix
  - Report preparation
  - Report approval
  - Health and safety
  - Environmental considerations
  - Data collection
  - Data validation
  - Data submission
  - Data storage

- Experimental design, including details on replicates and controls
- Section detail
  - Section number
  - Section details including district, county, route number, lane number and GPS coordinates
  - Test panel position
  - Pavement description
  - Construction, rehabilitation or maintenance required before testing can begin
  - Checklists
- Instrumentation
  - Inventory of instruments
  - Location and/or depth
  - Calibration
  - Measurement specifications
  - Data collection requirements (number and location of points and conditions under which measurements will be recorded)
  - Checklists
- Evaluation program
  - Evaluation requirements
  - Protocols/methods/criteria to be followed
  - Failure criteria definition
  - Associated laboratory testing
  - Checklists
- Data collection, validation and storage
  - Start date
  - Frequency of data collection
  - Data validation (visual, comparison with previous measurement, within predefined parameters)
  - Data transfer to Database Manager (timing, medium)
  - Criteria to be met for experiment completion
  - Checklists
- Reports
- General notes



Checklists should be prepared for each phase of the experiment. These should be used to guide the process and ensure that all parts are completed. They should be signed off by the responsible individuals on completion of a task.



It should be noted that experimental designs should always have an end point. It is thus imperative to include criteria that once met, will result in the termination of the experiment monitoring, data analysis and lead to a recommendation adopting the strategy, treatment, technology, procedure and/or product.

The above list can be used as a checklist to monitor content of the document. An example of such a checklist is provided in Appendix B (Checklist 4).

## **4.4. Experiment Work Plan Format**

### **4.4.1 Table of Contents**

The Experiment Work Plan should be formatted as follows (see Checklist 5 in Appendix B):

- Title Page
- Approval signatures
- Revision Notes
- Table of contents
  - Chapter 1: Objective of the test
  - Chapter 2: Staffing and contact details
  - Chapter 3: Responsibility and reporting matrix
  - Chapter 4: Experimental design
  - Chapter 4: Section detail
  - Chapter 5: Instrumentation
  - Chapter 6: Monitoring program
  - Chapter 7: Data collection, validation and storage
  - Chapter 8: Reports
  - Chapter 9: General notes
  - Appendices: Checklists and forms

### **4.4.2 Title and Numbering**

The title of the Experiment Work Plan should be a brief descriptor of the project.

Each Experiment Work Plan prepared should have a unique number to facilitate tracking of updates and changes and for archiving and retrieval purposes. The numbering system for Caltrans Pavement Preservation Experiments documents is maintained by the Chief of the Office of Pavement Preservation and is kept centrally (instead of District level) to track experiments statewide. It is linked to the proposal register described in the previous chapter. The document numbering system is discussed in Chapter 11.

#### 4.4.3 Example

An example of an Experiment Work Plan for a pavement preservation experiment is provided in Appendix C.

### 4.5. Experiment Initiation

The experiment can be initiated as soon as:

- The Project Champion has given final written approval for the work plan
- An experiment number has been issued by the Chief of the Office of Pavement Preservation
- The project team has accepted responsibility for the tasks assigned to them in the work plan

A copy of the approval should be kept in the Project File. A checklist for experiment initiation is provided in Appendix B (Checklist 6).

### 4.6. Revisions

The Experiment Work Plan is a live document and might change during the course of an experiment as monitoring progresses. Changes must only be made in order to meet the original objectives of the study and must be agreed to by all individuals involved in preparing the original Work Plan. Examples of changes may include different monitoring intervals, the use of different equipment to measure specific parameters, additional tests, maintenance interventions, etc. Extensions of the experiment may also be justified.

Any changes to the Experiment Work Plan must be documented in a revision and a new version issued. The new version must be re-approved before implementation. The changes and section numbers in which the changes have been made should be listed on the first page of the revised document.

The Project Engineer is responsible for changes, obtaining approvals, circulation of the revised document and ensuring that the changes are implemented.

### 4.7. Quality Management



Quality management issues pertaining to the roles and responsibilities described in this chapter include:

- The preparation of a responsibility matrix
- The preparation of a comprehensive Experiment Work Plan that defines and allocates all responsibilities required to meet the objectives of the experiment
- Approval of the Experiment Work Plan by all contributors

- Documenting all changes to the Experiment Work Plan in revised documents that are re-approved and issued with a revision number and date
- Setting criteria for experiment termination and subsequent decision making on whether or not to adopt the strategy, treatment, technology, procedure and/or product as standard Caltrans practice.

#### **4.7.1 Documentation Management**

The Experiment Work Plan should be stored in the Project File. New versions of the Work Plan should be circulated to all relevant parties by the Project Engineer.

#### **4.7.2 Responsibility**

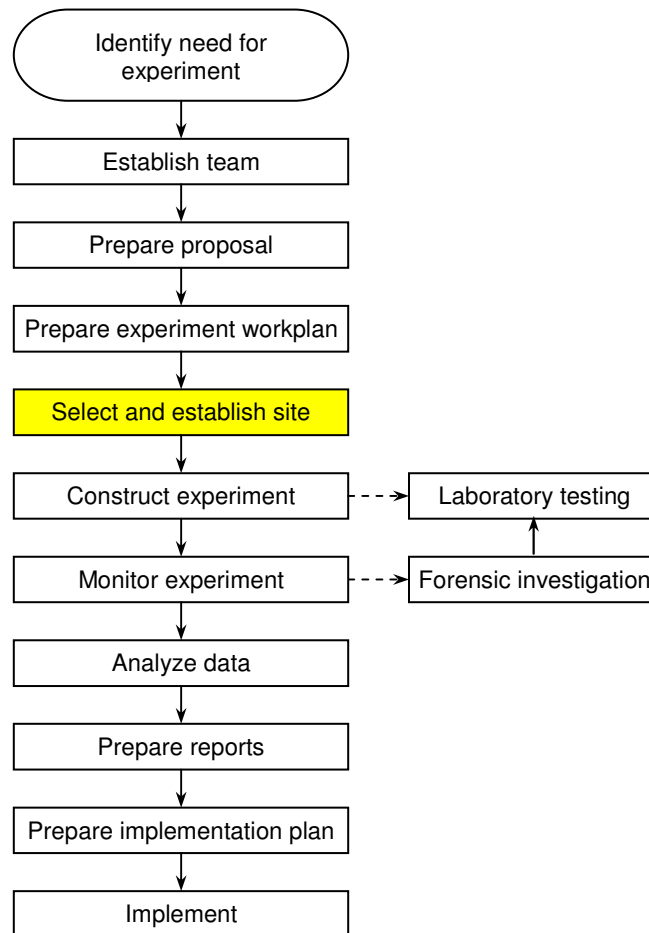
The Project Engineer is responsible for:

- Project Management
- Compiling and revising the Experiment Work Plan. It is imperative that this responsibility remains with the Project Engineer, unless he/she delegates it to someone else, in order to prevent uncoordinated and unapproved changes to the Experiment Work Plan that may adversely influence meeting the original objectives.
- Ensuring that new versions of the Experiment Work Plan are approved, distributed and added to the Project File

The Project Champion retains overall responsibility for approving and implementing the Work Plan.

## 5. SITE SELECTION

---



### 5.1. Introduction

Site selection is critical. The site needs to be representative of roads, traffic and environment where the

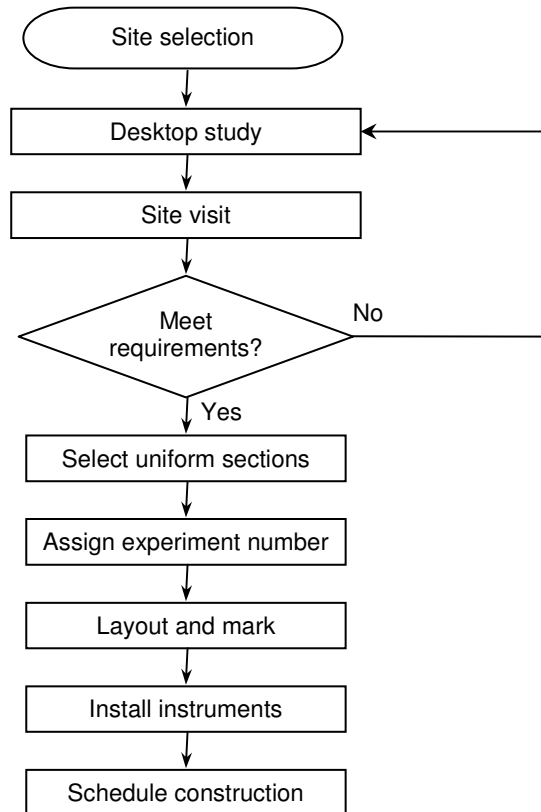


pavement preservation strategy might be used if proved successful in the proposed experiment. If feasible, experiments can be combined to optimize monitoring schedules and comparisons between ongoing performances of the different studies. All experiments should include a control section and replicates. Control sections are typically the standard pavement preservation strategy that would have been used. For example, if a new chip seal design is being assessed,

the experiment should include a section constructed using the existing chip seal design so that a direct comparison of performance can be made. Replicates are typically included to assess variability at each

site and the influence of, for example, climate and traffic between sites. Replicates for assessing the effect of traffic and/or structure can often be accommodated by using side-by-side experiments on different lanes/directions if traffic differences between the lanes/directions are sufficiently large.

In this chapter, site selection procedure, experiment numbering, layout and marking, and instrument installation are discussed. A flow chart depicting the processes covered in this chapter is provided in Figure 5.1.



**Figure 5.1: Flowchart for site selection**

## 5.2. Procedure

The identification and selection of experiment sections will depend on the specific criteria and objectives of the study. The following general issues should, however, be considered when selecting sections:

- Sections should be representative of the issue being investigated and results obtained from these sections should be representative of other roads with similar conditions.
- Where possible experiments should be conveniently located for monitoring and or demonstration purposes.

- Individual sections within the experiment, including the control, should be similar in terms of alignment, structure, traffic carried, and condition. Side-by-side sections should not be used for direct comparison, but can be used for replicates to assess differences in traffic and/or structure.
- The establishment of the section should not pose a safety hazard to road users, or be positioned so that the safety of the persons monitoring the section is jeopardized.
- The road on which the section is being located should not be maintained, rehabilitated or resealed within the planned monitoring period, unless assessment of that intervention is part of the monitoring program and prior warning is given to the Project Engineer.
- Sections should be located as close as possible to traffic counting/weigh-in-motion stations, unless a station is incorporated into the section.
- Sections should be selected such that testing to “failure” of certain sections can be completed and then repaired without significant impacts to the road user.



Road is curved, sight distance is limited, and structure is inconsistent



Road is straight, safe and consistent

The procedure involves three main stages:

- Desktop study
- Site visit
- Approval

### 5.2.1 Desktop Study

The desktop study, undertaken by the Project Engineer in consultation with the District Engineer(s), is done to identify and evaluate all available alternatives that meet the requirements of the Experiment Work Plan in general and the experimental design in particular, bearing in mind that pavement preservation experiments are typically incorporated into planned pavement preservation activities. A shortlist of potential sites, including replicates if applicable, will be prepared as an output. A checklist, based on the

requirements of the Experiment Work Plan, should be completed to ensure that no issues are overlooked. An example of a desktop study checklist is included in Appendix B (Checklist 7). Examples of issues to consider include, but are not limited to:

- Can the planned strategies/treatments be accommodated in the operation?
- Can the planned pavement preservation strategy/treatment on the selected section be used as a control?
- Is the planned operation long enough to accommodate the experiments, each of which must be long enough to ensure that the contractor can construct a representative section?
- Is the alignment uniform?
- Is the planned operation long enough to accommodate replicate sections?
- Are there any potential problems with later monitoring activities (e.g., road closures)?
- Are there constraints outside the Experiment Work Plan that could influence the use of the site (e.g., safety or environmental issues)?
- Is appropriate construction equipment available?
- Are there appropriately trained personnel to do the treatments?
- Can the contractual arrangements be modified to accommodate the experiment?

CHECKLIST - EXPERIMENT INITIATION				Checklist #
General Issues	Yes	No	Comments	
1 Has the Project Champion given written approval to proceed with the experiment?				
2 Has a copy of the approval been added to the Project File?				
3 Has an experiment number been issued by the Chief of the Office of Pavement Preservation?				
4 Has a project team been assembled?				
5 Has the project team accepted responsibilities as assigned in the experiment work plan?				
6 Have all necessary arrangements been made to proceed with the experiment?				
7				
8				
9				
10				
11				
12				
Can the experiment proceed? If no, state why and what needs to be done to continue				Yes No
Name	Signature	Date		

The selected sites should be ranked according to appropriateness. If replicate sections are required, these should be identified in the ranking. Ranking can be simplified by giving a score (on a scale of 1 to 3 where 1 is satisfactory, 2 is acceptable with exceptions and 3 is unsatisfactory) to each of the above questions.

**5.2.2 Site Visit**

Following the desktop study, the Project and District Engineers and, if applicable, the supplier(s) of any products that might be evaluated, should visit the selected locations and identify the most appropriate site(s). Non-destructive (e.g., profile, falling weight deflectometer) and/or destructive [e.g., test pit, coring, Dynamic Cone Penetrometer (DCP)] testing, together with a visual assessment, may be required to characterize the site. Criteria used to select sites could include, but not be limited to:

- Total and selective surface treatments
  - Riding quality [e.g., International Roughness Index (IRI)]
  - Cracking (e.g., length of crack in mm/km plus crack width or percentage area cracked)
  - Rut depth (e.g., mm)
  - Bleeding/punching [e.g., severity (1-5) and extent (percentage area)]

- Total surface treatments
  - Age (e.g., years or period since last treatment)
  - Skid resistance [e.g., Skid Number (SN)]
  - Pavement structure (e.g., deflection in micron, DCP number, back calculated modulus)
- Selective treatments
  - Potholes



Site selection based on pavement structure (FWD)



Site selection based on skid resistance (Dynamic friction tester)

Uniformity of these criteria, and specifically the pavement structure, within the selected site is critical to the success of the experiment so that comparisons of performance between sections and other analyses are accurate. The identification of uniform sections within the selected site is thus an important task. Uniformity is relative to the length of the experiment. For short sections [e.g., <200 m (600 ft)] there should be minimal variation in the key parameter being assessed. For longer sections (e.g., 1.0 km or 1.0 mile), some variability is inevitable, but at least the middle 300 m (1,000 ft) should be uniform and the key parameter should not differ by more than 10 percent on the remainder of the section.

Issues to consider when selecting uniform sections include, but are not limited to:

- Total and selective surface treatments
  - Riding quality - the entire length of the available road should be measured and uniform sections of the required length selected from the data. A variation of not more than 10 percent is permissible. Sections can be distributed along the length of the available road and need not all be next to each other. If there is a distinctive change over the length of the section, then replicates can be considered, one in a smoother area and one in a rougher area.
  - Cracking - the characteristics of the cracking, in terms of the evaluation criteria used, should be consistent along the length of the section.



- Rut depth - the rut depth should not vary by more than  $\pm 3.0$  mm (0.1 in.) along the length of the section
- Bleeding/punching - the severity and extent of the bleeding and/or punching should be the same throughout the length of the experiment. Replicates can be considered if the severity and/or extent change by more than one rating point along the length of the selected site.



Consistent cracking on selected section



Consistent bleeding/stone loss on selected section



Inconsistent rutting and cracking



Inconsistent spalling, cracking, and faulting

- Total surface treatments
  - Age - the entire length of the section should be the same age and should have been constructed at the same time as part of the same contract.
  - Skid resistance - the entire length of the available road should be measured and uniform sections of the required length selected from the data. A variation of not more than 10 percent is permissible. Sections can be distributed along the length of the available road and need not all be next to each other. If there is a distinctive change over the length of the section, then replicates can be considered, one in the smoother area and one in the rougher area.

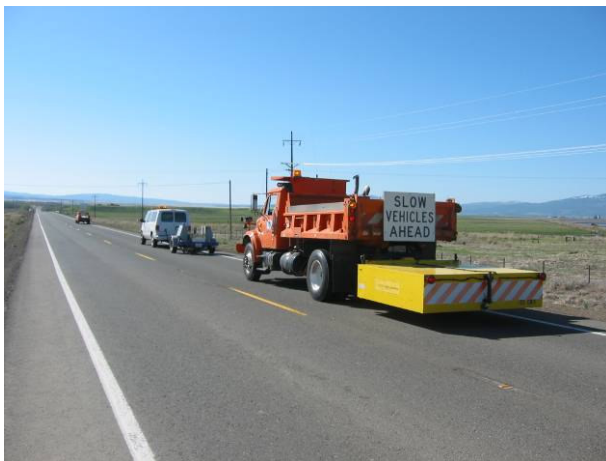
- Pavement structure - sufficient deflection and/or DCP measurements should be taken to ensure that at least five readings are used to identify any one section. Thus a measurement should be taken at least every 20 m. A variation of not more than 10 percent is permissible. Sections can be distributed along the length of the available road and need not all be next to each other. If there is a distinctive change over the length of the section, then replicates should be considered.

### 5.2.3 Safety Considerations

Pavement preservation experiment sections should only be located where they will have minimum impact on road user safety and on the safety of individuals and equipment during monitoring exercises. Experiments should thus only be located where there is good visibility and sufficient space to accommodate traffic.

### 5.2.4 Environmental Considerations

Test sections should not be constructed in sensitive environments where construction activities may have significant impacts or where runoff or leachate from treatments could influence surrounding ecosystems. Environmental conditions should also not influence the sections in any significant way unless they are included as factors in the experimental design. For example, the experimental sections should have adequate drainage.



Example of a safe experimental section



Example of an environmentally sensitive road - experiments should be avoided in these areas.

### 5.2.5 Other Considerations

There are a number of other issues that should be considered when selecting a site or sites for an experiment. These include, but are not limited to (see Checklist 8 in Appendix B):

- Where possible, the proposed sections should be conveniently located for monitoring and demonstration purposes

- Planned maintenance or rehabilitation on the road during the period of experimentation should be established and the consequences determined. If planned maintenance is not part of the evaluation, steps will need to be taken to ensure that none takes place.
- Where possible, sections should be located as close as possible to traffic counting, weigh-in-motion and/or weigh stations to ensure that accurate traffic records are used in the analyses.
- In many instances, it is desirable to test the road to the predefined failure criteria. The implications of testing to failure, including required repairs and disruptions to traffic need to be determined before committing to a site.

### **5.2.6 Preliminary Site Report and Approval**

Once a site, or sites if a factorial experimental design is being followed or replicates are being considered, has been selected, a brief site report should be prepared by the Project Engineer detailing the following:

- Site selection process
- Criteria used to select individual sections
- Exact locations of each section (mileage from a fixed point and GPS coordinates)
- Measured parameters for each section
- Safety and environmental considerations

The Experiment Work Plan should also be updated to incorporate the exact section locations and numbering and a new version issued.

Approval of the location(s) should be signed off by the following individuals:

- Project Champion
- Project Engineer
- Database Manager

### **5.3. Experimental Section Numbering**

Each experiment, and section within the experiment if applicable, should be assigned a unique number for management purposes. A number should be obtained from the Chief of the Office of Pavement Preservation.

**PPTS/3/05/1/1**

This number will be linked to the proposal and experiment specification registers described in the previous chapter. Examples of the register format and numbering system are provided in Chapter 11.

Obtaining the experiment and section numbers should be the responsibility of the Project Engineer. The numbers used should correspond to those used in the Experiment Work Plan and on all subsequent reports.

## 5.4. Experimental Section Layout and Marking

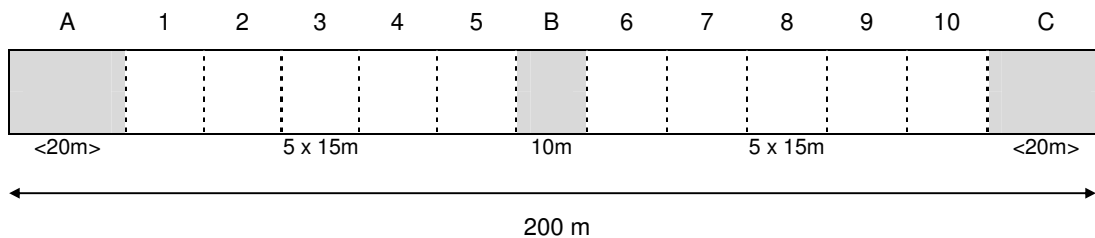
Labeling and marking of the test sections and control should be the responsibility of the Project Engineer. Once selected the test sections should be labeled, marked and instrumented according to the requirements of the Experiment Work Plan. Suitable signs should be erected at either end of the experiment with experiment details and a contact number or website where Caltrans staff can obtain additional information and notify the Project Engineer of any observations or interventions that may be necessary.

The length of the experiment will be detailed in the Experiment Work Plan and will vary depending on the treatment being assessed. Typical sections lengths are:

- Total surface - 200 m (600 ft)
- Selective surface - sufficient length to have at least 12 replicates with the same treatment (i.e., 12 cracks, 12 potholes, 12 joints)

Long test sections are more representative of the road and allow the collection of larger quantities of data. However, they are time consuming to evaluate and variability along the length of the section will need to be accounted for. The length of the test section thus needs to be optimized such that the experiment objectives can be satisfactorily met.

- Experimental sections that assess total surface treatments can be divided into two parts - a larger experiment over which riding quality is measured (e.g., 500 m) and a shorter section (e.g., 200 m) in the middle where the visual assessment and more precise measurements are taken. The same applies to experiments where construction is a factor. The larger experiment will typically cover a full-day production (e.g., 1.5 km or 1.0 mi) with one or more representative 200 m (600 ft) sections within the larger experiment. Each detail section can be further divided into panels to facilitate evaluation. The control section dimensions should be identical to those of the experiment. An example of a layout typically used for experiments assessing total surface is provided below (Figure 5.2):



**Figure 5.2: Example layout of experimental section (one lane width)**

- 2 x20 m (65 ft) panels (A and C) at either end for destructive testing (DCP, density and moisture content, core)
- 1 x10 m (32 ft) panel (B) in the middle for destructive testing (DCP, density and moisture content, core)
- 10 x15 m (50 ft) panels (1 - 5 and 6 - 10) for general performance assessment

The GPS coordinates of the start of Panel A, center of Panel B, and end of Panel C of each section and the chainage (distance from the post-mile marker) at the beginning and end of each section should be taken and recorded in the database to facilitate location.

Each section should be marked as follows:

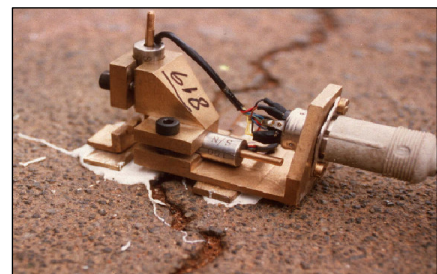
- Signboards with the section number should be erected at either end of each section against the fence line/edge of the road reserve. If additional sections are incorporated for riding quality measurements, additional signs should be erected at the start and end point as well.
- Each section should be demarcated and numbered with white road marking paint (Figure 5.2). Locator points for specific measurements [e.g., deflection (FWD)] should also be painted.

A “map” of each section should be drawn after completion of the demarcation and filed in the Project File at a central point to facilitate future assessments. An example of an experiment map is provided in Appendix C.

## 5.5. Instrument Installation

In certain instances, experimental sections may be instrumented in order to collect specific data. Instrumentation requirements will be detailed in the Experiment Work Plan. Typical instrumentation could include, but is not limited to:

- Temperature or temperature/humidity buttons
- Thermocouples
- Strain and or deflection gages
- Crack activity measuring instruments
- Traffic counters and or weigh-in-motion sensors



Crack activity measurement

Instrumentation should be installed and calibrated as prescribed by the manufacturer/supplier, if necessary by trained, experienced and competent technicians.

The control section must be instrumented exactly the same as the experimental sections.

The Project Engineer must oversee the calibration and installation of the instrumentation.



## 5.6. Weather Station

Weather data will be an important component of the analysis. If there is no suitable weather station in the vicinity of the experiment, a station comprising at least a thermometer (maximum and minimum) and a rain gage should be erected as close as possible to the section.



## 5.7. Checklists

Checklists for site location, layout and marking and instrumentation should be completed and signed off by the Project Engineer and approved by the Project Champion. Examples of checklists for the chapter are provided in Appendix B.

## 5.8. Final Site Report and Approval

Once the site has been marked, signed, and instrumented, a final site report should be prepared by the Project Engineer and approved. This report will incorporate the preliminary site report detailed earlier, together with the following:

- Experiment number
- Experiment map
- Details of instrumentation location, installation, and calibration

Approval of the site report should be signed off by the following individuals. Report approval signifies that construction can commence.

- Project Champion
- Project Engineer
- Database Manager

## 5.9. Quality Management



Quality management issues pertaining to the roles and responsibilities described in this chapter include:

- Identification of a suitable location for the experiment
- Issuing each section a unique number
- Layout of the sections according to the Experiment Work Plan
- The drawing of a “map” of the section with all relevant information including instrumentation
- The completion and signing of checklists for each stage

### **5.9.1 Data Management**

Data collected during this phase of the experiment will typically include a “map” of the experiment (treated sections and control), a list of the instrumentation with locations and details of calibration, and details of the weather station. Section numbers will need to be recorded in a central experiment register. All documentation generated during this phase of the experiment should be added to the Project File.

### **5.9.2 Responsibility**

The Project Engineer has overall responsibility for:

- Locating the experiment
- Laying out and marking the sections
- Obtaining experiment and section numbers
- Preparing a “map” of the experiment
- Overseeing the calibration and installation of the instrumentation
- Revising the Experiment Work Plan
- Completing all checklists
- Recording the details of the experiment in the experiment register
- Maintaining the Project File

The Database Manager is responsible for:

- Entering the experiment details in the database

The District Engineer is responsible for:

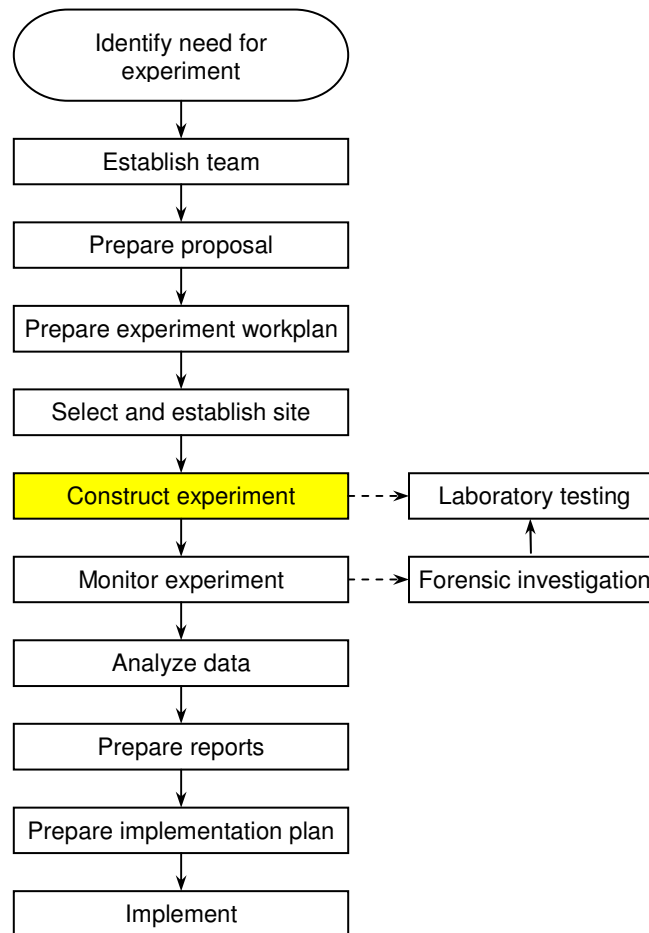
- Approving the location of the site

The Project Champion has overall responsibility for:

- Ensuring that the site meets the objectives of the experiment
- Ensuring that all Caltrans requirements in terms of safety and environment are met
- Approving all checklists

## 6. EXPERIMENT CONSTRUCTION

---



### 6.1. Introduction



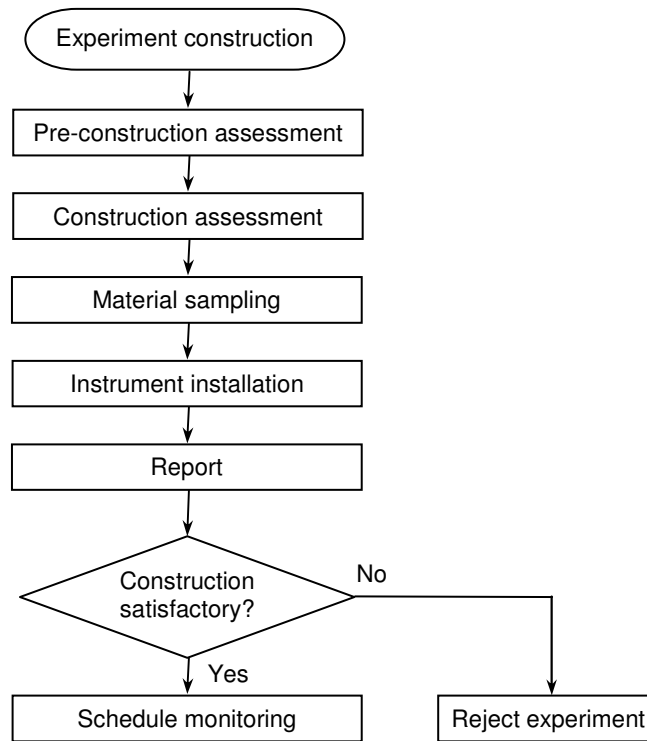
The performance of any road is directly related to the quality of construction. It is therefore imperative that the construction process is closely observed so later performance can be related back to it. Since pavement preservation strategies are being evaluated, it is also very important that the road is comprehensively evaluated before any work is undertaken in order to determine the level of success of the strategy.

When undertaking any assessments, observations or measurements, it should always be kept in mind that the data



will ultimately be used in an analysis to determine the effectiveness of the technique and/or product being assessed. Careful consideration should thus be given to the manner in which the assessments are recorded such that quality analysis can be undertaken and valid conclusions drawn.

In this chapter, pre-construction assessment, construction assessment, material sampling and instrument installation are discussed. A flow chart for the chapter is shown in Figure 6.1.



**Figure 6.1: Flowchart for experiment construction**

## 6.2. Pre-Construction Assessment

The experiment should be systematically and comprehensively assessed prior to construction. The assessment criteria used should be as detailed in the Experiment Work Plan and should remain consistent throughout the study. The California Pavement Condition Survey Manual and/or the FHWA Distress Identification Manual for the Long-term Pavement Performance Program should be used together with any additional requirements detailed in the work plan. Profile, riding quality and deflection, if specified in the Experiment Work Plan, should all be measured according to documented procedures.

Typical issues to consider in the pre-construction assessment include, but are not limited to (see Checklist 10 in Appendix B):

- Relevant distresses listed in the Visual Assessment Guide/Distress Identification Manual including, but not limited to:
  - Cracking (fatigue, block, edge, longitudinal, reflection, transverse, corner, durability)
  - Potholes and/or existing patching and patch deterioration
  - Surface Deformation (rutting, shoving)
  - Surface Defects (bleeding, polished aggregate, raveling, map cracking, scaling, popouts)
  - Miscellaneous Distresses (lane-to-shoulder drop-off, lane-to-shoulder separation, water bleeding and pumping, blowouts)
  - Joint Deficiencies (joint seal damage, spalling, faulting)
  - Longitudinal profile/riding quality
- Skid resistance
- Drainage on the road
- Drainage away from the road
- Structure (FWD, DCP)



Structural assessment. Note salt in cracks.



Poor drainage may influence experiment performance.

All observations should be recorded on a Pre-assessment Visual Assessment Form. The form in the Pavement Condition Survey Manual can be used. Alternatively, a customized form that suits the experiment, based on the form used in the Pavement Condition Survey Manual, can be used (Example Forms 1 and 2 in Appendix D). Any additional notes relevant to the experiment should also be noted on the form.

### 6.2.1 Reference Standards

- Caltrans Pavement Condition Survey Manual
- Distress Identification Manual for the Long-Term Pavement Performance Program

### 6.3. Construction Assessment

Every aspect of the construction process, from preparation of the surface through cleaning up excess materials (e.g., brooming after chip seal application) can influence later performance of the treatment. The entire process thus needs to be observed and systematically documented so later performance can be linked to the construction process where applicable. Such observation may also form the basis of a motivation to change construction practices or training programs within Caltrans to address any specific problem areas.

Examples of critical areas requiring observation include, but are not limited to:

- Calibration of the spray and stone application rate on fog seals and chip seals
- Brooming of excess stone after chip seal application
- Repair of distress prior to overlay treatments
- Checking binder temperature
- Checking compaction techniques
- Cleaning process and effectiveness in crack, joint and pothole repairs
- Reviewing quality control and quality assurance procedures



Chip spreader calibration



Brooming of excess chip seal stone

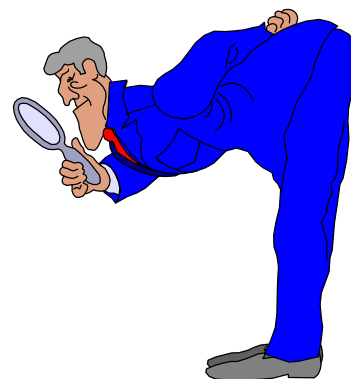
#### 6.3.1 Proprietary Products

If a proprietary treatment is being assessed, then the manufacturer or supplier should appoint a technical representative to provide advice on the project. They should also provide a step-by-step procedure together with checklists that need to be followed in order to ensure that the experiment is constructed correctly. The procedure must clearly state situations to avoid and the consequences if they are not.

The Project Engineer and technical representative must oversee the entire construction process and must take responsibility for ensuring that the section is constructed as required. The checklists should be signed off by both individuals on completion of the study as part of the quality management procedure.

**6.3.2 Observation**

The Caltrans Project Engineer must supervise and systematically document the entire construction process from site preparation through to opening the road to traffic. If applicable, any deviations from procedures for proprietary products should be noted. On completion, the Project Engineer must be fully satisfied that the test section is representative of the Experiment Work Plan and that sufficient data have been collected from the construction process to adequately relate later performance to the road prior to treatment, and to construction. A video of the process from an appropriate vantage point may assist in relating performance to construction when analyzing the collected data.



Typical issues to consider when observing construction include, but are not limited to (see Checklist 11 in Appendix B):

- Systematic documentation of the process and deviations from the procedure provided
- Treatment (e.g., binder, aggregate, sealant) source and characteristics
- Equipment type and condition
- Calibration procedures
- Surface, crack or pothole preparation
- Compaction
- Establishment, application and demobilization time
- Quality control and quality assurance processes followed
- Uniformity
- Wastage
- Problems encountered and how they were dealt with
- Recommendations to improve the process

All observations should be documented on a Construction Assessment Form. The contents of the form will depend on the type of treatment. An example of a form (chip seal experiment) is provided in Appendix D (Form 1). A checklist, relevant to the pavement preservation treatment (example in Appendix B), should be completed to ensure that all aspects of the construction process have been documented and recorded.

CHECKLIST - EXPERIMENT INITIATION				Checklist 6
General Issues	Yes	No	Comments	
1 Has the Project Champion given written approval to proceed with the experiment?				
2 Has a copy of the approval been added to the Project File?				
3 Has an experiment number been issued by the Chief of the Office of Pavement Preservation?				
4 Has a project team been assembled?				
5 Has the project team accepted responsibilities as assigned in the experiment work plan?				
6 Have all necessary arrangements been made to proceed with the experiment?				
7				
8				
9				
10				
11				
12				
Recommendation				
Can the experiment proceed?				Yes   No
If no, state why and what needs to be done to continue				
Name		Signature		Date





Poor quality construction - thickness control



Poor quality construction - contamination



Poor quality construction - segregation



Poor quality construction - drainage impairment

### 6.3.3 Measurement

A quantitative measure is always more useful than a subjective observation when analyzing data collected from an experiment. Where feasible, any component of the process being assessed that can be measured should be measured with appropriate calibrated equipment and the data recorded, either on an appropriate form, or electronically depending on the parameter and the equipment used.

Typical parameters that can be measured during construction include, but are not limited to:

- Haul distances and times
- Time taken for each component including opening and closing times
- Characteristics of the surface before and after treatment:
  - Rut depth
  - Crack length, depth and width
  - Pothole shape and depth



- Joint width
- Ride quality
- Skid resistance
- Noise
- Air and surface temperatures and other site weather conditions
- For overlays:
  - Asphalt concrete temperature
  - Thickness
  - Quantity applied per unit surface area
  - Compaction procedures (equipment, rolling patterns, number of passes, etc)
- For seals:
  - Binder temperature
  - Spray rate
  - Aggregate size, shape and quantity applied per unit area
- For patches:
  - Thickness
  - Quantity applied per unit surface area
- For cracks
  - Sealant temperature
  - Sealant applied per linear meter
- Density after compaction



All measurements should be recorded on the Construction Assessment Form together with the observations discussed in the previous section. Copies of the Resident Engineer's and Inspector's note books should be obtained where possible.

#### 6.3.4 Reference Standards

- Caltrans Pavement Condition Survey Manual
- Distress Identification Manual for the Long-Term Pavement Performance Program

#### 6.4. Material Sampling

Representative samples of all the materials used in the pavement preservation treatment should be collected at appropriate times throughout the construction procedure. Two types of sample may be collected, namely for:

- Laboratory testing
- Reference purposes

Quantities and replicates will depend on the tests detailed in the Experiment Work Plan. A sample log should be kept with details on:

- Sample number
- Material
- The exact location from where the sample was taken (using X, Y and Z coordinates)
- Name of the person who took the sample
- Time that the sample was taken (actual and in terms of the process)
- Where and under what conditions the sample was stored
- Where the sample was sent to and when
- Name of the sample owner



All samples should be appropriately labeled with at least the following (example label provided in Appendix E):

- Experiment and section number
- Sample number (linked to sample log discussed above)
- Date
- Sample description
- Sample owner
- Destination

Experiment No	MT3/3/05/1/1
Sample No	1
Date	09/17/05
Sample owner	A. Nore
Destination	Detroit 3 Materials Lab

Typical samples that might be taken include, but are not limited to:

- Binder
- Aggregate
- Asphalt concrete mix
- Crack or joint sealant
- Pothole filler
- Fabric, grid or reinforcing
- Pre-treatment cores
- Post-treatment cores



Records of all samples should be noted on the Construction Assessment Form.



### 6.4.1 Reference Standards

- California methods for sampling highway materials and products used in the roadway structural sections
- California Test Methods

## 6.5. Instrument Installation

If applicable, the type of instrumentation and location will be detailed in the project specification. Instrument installation and calibration should be carried out by a trained technician according to the procedure specified by the manufacturer and overseen by the Project Engineer.

Typical instrumentation may include, but is not limited to:

- Thermocouples
- Temperature and temperature/humidity buttons
- Strain gages
- Crack activity measuring instruments



Records of the instrument installation, precise location and calibration details should be noted on the Construction Assessment Form.

### 6.5.1 Reference Standards

- Manufacturers' specification and manual

## 6.6. Checklists

All relevant issues will be listed on the construction checklist, which must be signed off by the Project Engineer(s) on completion of construction. Examples of the checklists relevant to this chapter are provided in Appendix B.

## 6.7. Construction Report and Approval

When construction is complete, a report should be prepared summarizing the construction process and detailing any specific issues that may influence performance and how these should be assessed during later monitoring evaluations. Deviations from the Experiment Work Plan should be listed. Assessment forms, checklists, and other records, including the contractor's as-built records should be included as appendices.





The report should also clearly state whether procedures were such that a satisfactory experiment has been constructed and that monitoring should continue. If construction is deemed to be unsatisfactory, the project team will need to meet and discuss the implications on the experiment. If the team believes that the outcome of the experiment will be unacceptably influenced then a decision will need to be taken on whether to proceed or not. The record of decision should be documented and filed in the Project File.

The construction report should be signed off by the following individuals:

- Project Champion
- Project Engineer
- Database Manager

Report approval signifies that monitoring of the experiment can continue.

## 6.8. Quality Management



Quality management issues pertaining to the roles and responsibilities described in this chapter include:

- Observing and documenting the entire construction process
- Measuring all relevant parameters at the time and to the requirements specified in the Experiment Work Plan
- Sampling all relevant materials at the time and to the requirements specified in the Experiment Work Plan
- Installing and calibrating instrumentation according to the manufactures specifications
- Completing all relevant checklists, forms, and labels

### 6.8.1 Data Management

Considerable data will be collected during experiment construction and may include, but is not limited to:

- Pre-construction assessment
- Construction assessment
- Post-construction assessment
- Material sample details
- Instrumentation details

Data should be recorded on appropriate forms designed to meet the needs of the experiment. Examples of forms are provided in Appendix D. Mandatory information should include:

- Name of evaluator
- Date
- Route number

- County/district
- Section name and number
- Signature of evaluator
- Signature of person performing quality management

All documents should be added to the Project File. In order to facilitate later data analysis, all data from the forms should be captured into a spreadsheet as soon as possible after construction. Timely capture will enable checks to be made and any missing data to be collected while the construction process is still clear in the Engineer's mind. A copy of the spreadsheet, named according to the experiment naming principle described earlier, plus date, should be forwarded to the Database Manager.

### **6.8.2 Responsibility**

The Project Engineer is responsible for:

- Observing and documenting the construction process
- Overseeing the sampling of materials
- Overseeing instrument installation
- Completing all relevant documentation and checklists
- Maintaining the Project File

The Database Manager is responsible for:

- Capturing all relevant data in the database

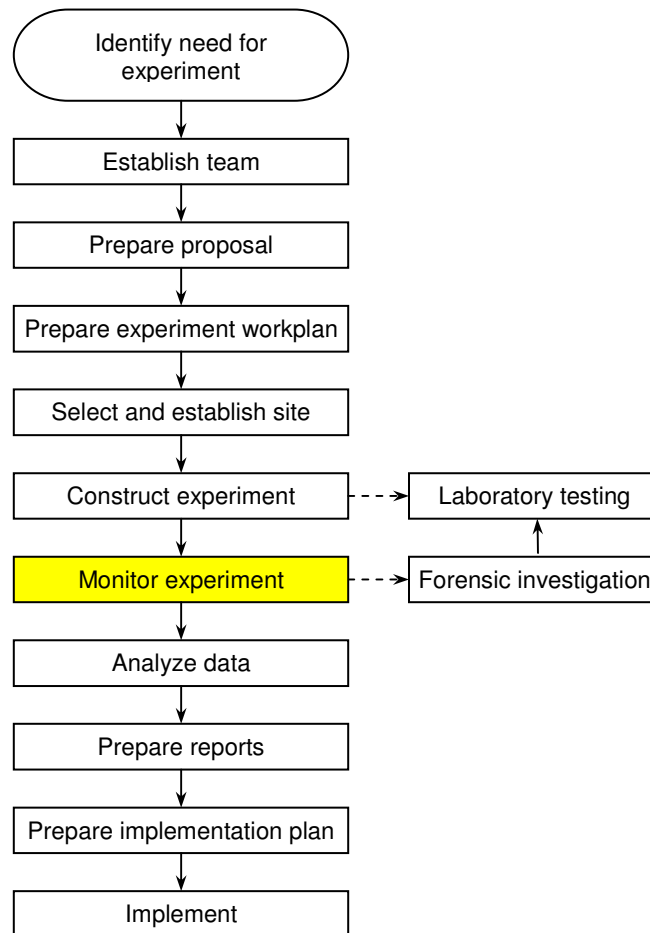
The Project Champion is responsible for:

- Deciding whether the construction process is sufficiently satisfactory that the experiment can proceed
- Approving all checklists and other relevant documentation

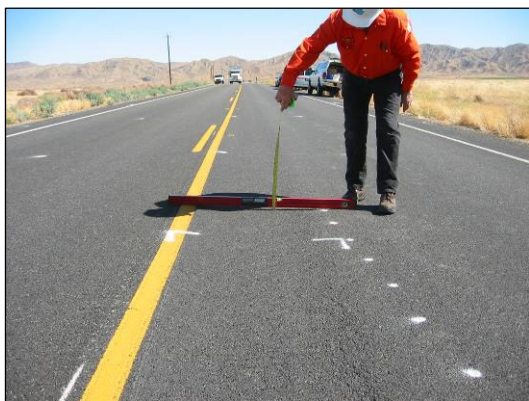


## 7. EXPERIMENT MONITORING

---



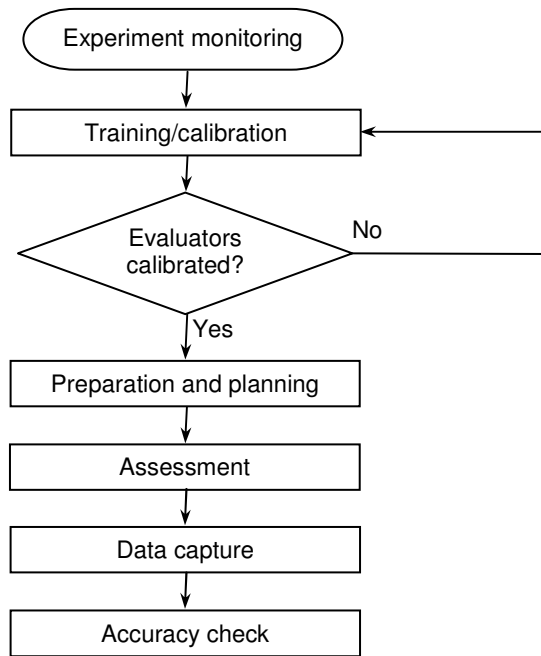
### 7.1. Introduction



Experiment monitoring is the phase during which most of the data that will be used in the analysis is collected. Experience has shown that it is also the phase when studies lose momentum and are even abandoned as new interests are followed and/or staff move on to other activities, positions or employment. It is thus important to maintain interest in experiments and ensure that the monitoring program is adhered to. Movement of staff should not affect successful completion of a study.

In this chapter, background information on experiment monitoring is provided, operational issues, the monitoring timetable, protocols and criteria are detailed and the visual assessment procedure and

measurements and sampling are discussed. A flow chart depicting the processes covered in this chapter is provided in Figure 7.1.



**Figure 7.1: Flowchart for experiment monitoring**

## 7.2. Background

### 7.2.1 Attributes Of Distress

The appearance of distress is varied and often extremely complex. The task of describing this is achieved by recording its main characteristics - the so-called attributes of distress. The attributes typically used in assessment are type, degree and extent.

These attributes are defined below in general terms. Detailed explanations relevant to each type of distress are described in the Pavement Condition Survey Manual and similar appropriate visual assessment guides.

Type of Distress - The type of distress evaluated will depend on the purpose of carrying out the assessment. For example, types assessed on chip seal overlays will differ from those on joint seal experiments. A number of assessment parameters are considered essential for any type of evaluation, while detailed descriptions of particular distress types will be required for specific pavement preservation treatments. Typical parameters assessed include, but are not limited to:

- Cracking (fatigue, block, edge, longitudinal, reflection, transverse, corner, durability)
- Potholes and/or existing patching and patch deterioration

- Surface deformation (rutting, shoving)
- Surface defects (bleeding, polished aggregate, raveling, map cracking, scaling, popouts)
- Miscellaneous distresses (lane-to-shoulder drop-off, lane-to-shoulder separation, water bleeding and pumping, blowouts)
- Joint deficiencies (joint seal damage, spalling, faulting)
- Functional performance (ride quality, skid resistance, spray, noise, etc)



Longitudinal crack in new overlay



Surface distress in new overlay



Surface deformation



Ravelling from chip seal



Pumping in new overlay



Joint problem

These can be assessed individually or in terms of their interactive effect on the functional performance of the road together with deflection, material properties, road profile (transverse and longitudinal), drainage, etc. An example of this is the development of potholes, which result in deterioration of overall functionality, particularly riding quality.

Degree - The degree of a particular type of distress is a measure of its severity. Because the degree of distress can vary over the pavement section, the degree to be recorded should, in connection with the extent of occurrence, give the predominant severity of a particular type of distress. The degree is described by a number where:

- Degree 1 indicates the first evidence of a particular type of distress (“slight”).
- Degree 3 indicates a warning condition. This would normally indicate that intervention might be required in order to avoid the distress deteriorating to a severe condition.
- Degree 5 indicates the worst degree (“severe”). Urgent attention is required.

The general descriptions of degree of each type of distress are presented in Table 7.1. These descriptions relate to the possible consequences of each type of distress and therefore also to the

urgency of maintenance or rehabilitation. Degree 0 is recorded if the defect does not occur. Degree 1 generally indicates that no attention is required; degree 3 indicates that maintenance/improvement might be required in the near future, whereas degree 5 indicates that immediate maintenance/improvement is required. Specific classifications for the various types of distress are documented in the Pavement Condition Survey Manual (or other suitable document depending on the type of experiment), based on these general descriptions.



Degree 1 distress



Degree 3 distress

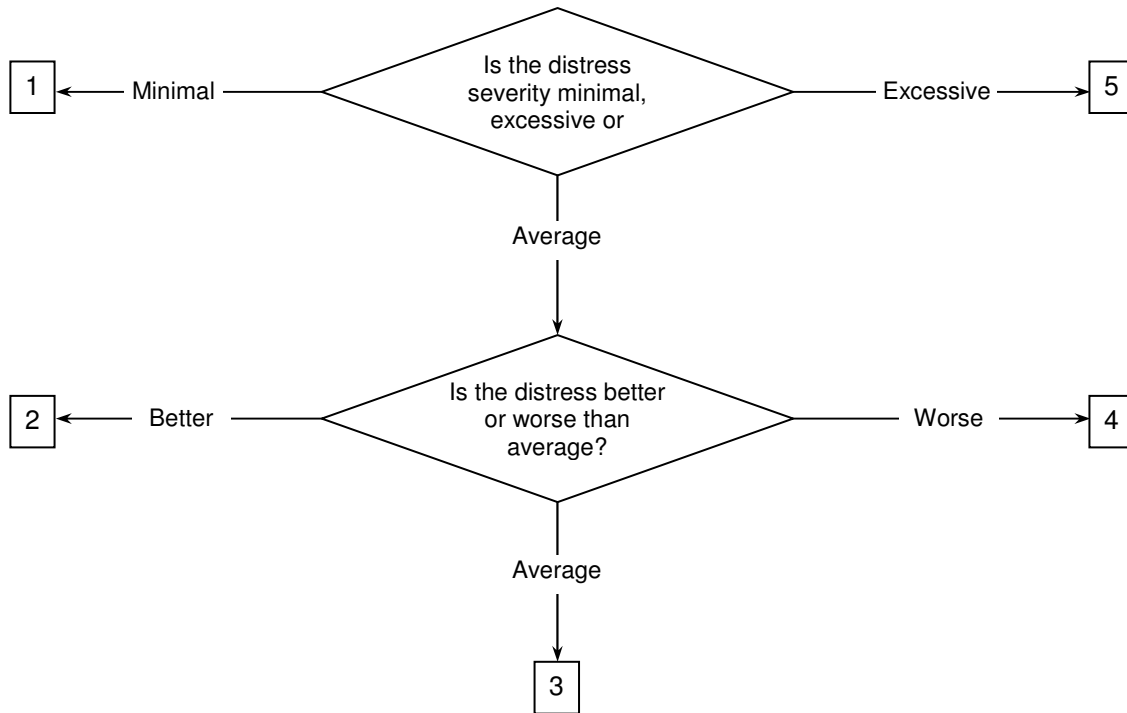


Degree 5 distress

A flow diagram illustrating the use of the five-point classification system is shown in Figure 7.2. The most important categories of degree are 1, 3 and 5. If there is any uncertainty regarding the condition between degrees 1 and 3 or 3 and 5, the defect may be marked as 2 or 4, respectively. This is particularly relevant for research purposes where frequent visual assessments are carried out.

**Table 7.1: General description of degree classification**

Degree	Severity	Description
0	None	No distress visible
1	Slight	Distress difficult to discern. Only the first signs of distress are visible.
2	Between slight and warning	Between slight and warning
3	Warning	Distress is distinct. Start of secondary defects. (Distress notable with respect to possible consequences. Remedial maintenance might be required in near future)
4	Between warning and severe	Between warning and severe
5	Severe	Distress is extreme. Secondary defects are well-developed (high degree of secondary defects) and/or extreme severity of primary defect. (Urgent attention required).



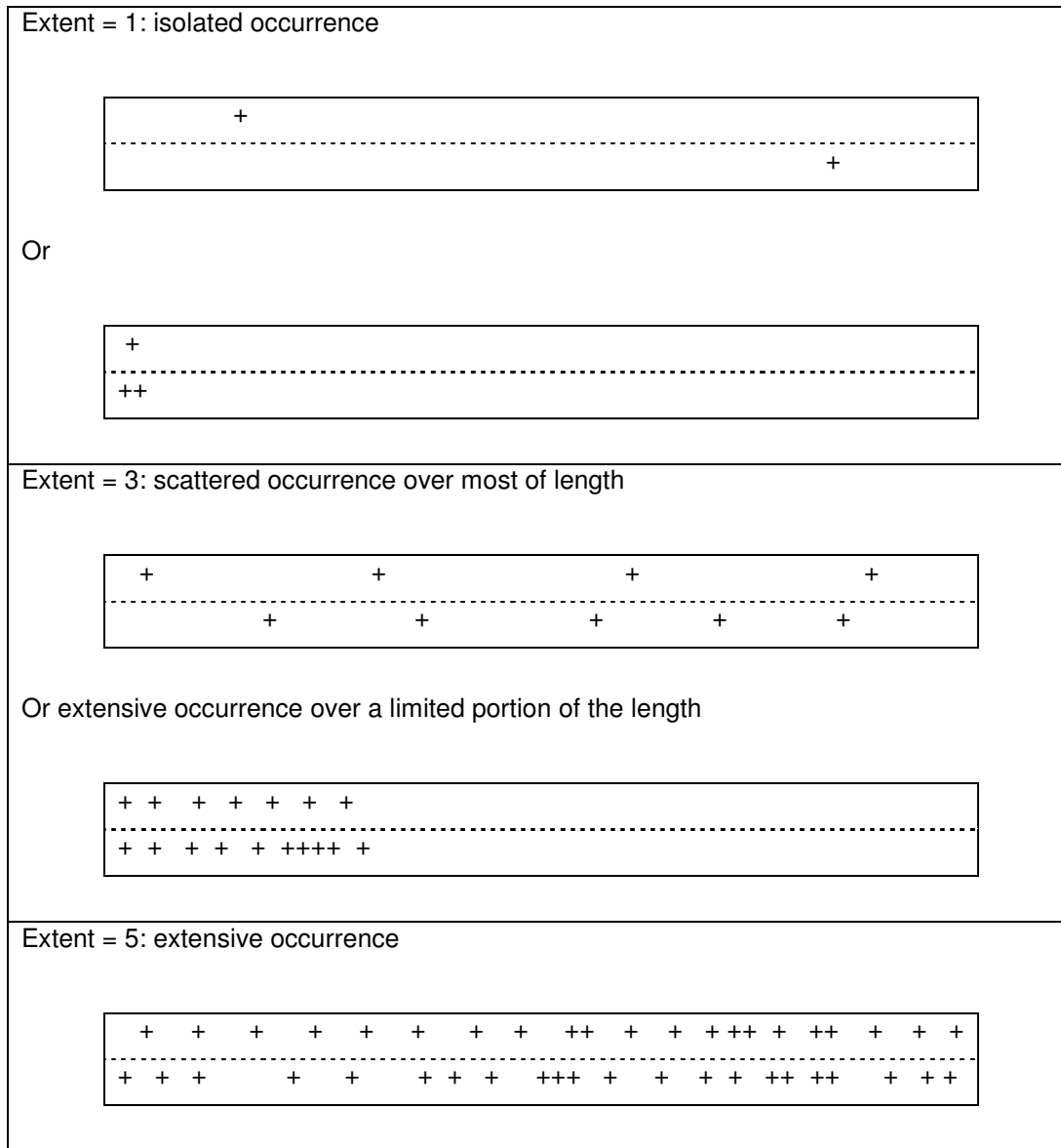
**Figure 7.2: Flow diagram – five point classification system**

Extent - The extent of distress is a measure of how widespread the distress is over the length of the experimental section or panel. The extent is also indicated on a five-point scale in which the length of road affected by the distress is estimated as a percentage. The general description of the extent classifications is given in Table 7.2 and illustrated diagrammatically in Figure 7.3.

**Table 7.2: General description of extent classifications**

Extent	Description	Estimate (%)
1	Isolated occurrence, not representative of the section or panel being evaluated.	< 5
2	Between 1 and 3	5 - 20
3	Intermittent occurrence, over most of the section or panel or extensive occurrence over a limited portion of the section.	20 - 60
4	Between 3 and 5	60 - 80
5	Extensive occurrence.	80 - 100





**Figure 7.3: Diagrammatical illustration of extent**

Experience has shown that even amongst experienced raters, there is a general tendency to overestimate the extent of defects. This tendency increases with severity of the defect.

Examples of the use of Degree and Extent - The following examples illustrate the combined use of degree and extent when assessing potholes:

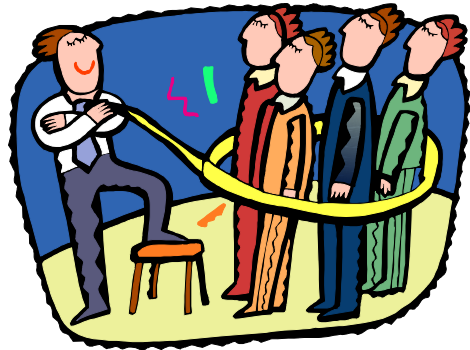
- If potholing of degree 5 occurs seldom (i.e., extent 1) and potholing of degree 3 occurs extensively (i.e., extent 5), the degree 3/extent 5 potholing is recorded as the predominant indication of the severity of potholing over the specific section. In such a case, the degree 5 potholing will be viewed as an area of localized distress requiring specific attention.

- If potholing of degree 5 and extent 2, and potholing of degree 1 and extent 4 occurs, degree 5/extent 2 is recorded as the average indication of the problem that is most significant in terms of possible action (potholing of degree 1 is not considered significant in terms of possible action).

Depending on the study, the maximum severity possible is often of equal or greater interest than the predominant severity. In terms of pavement preservation test sections, specific interest will be on those defects that the treatment was intended to address.

### 7.2.2 Training and Calibration of Evaluators

Numerous individuals may be involved in the evaluation of an experiment or series of experiments over the lifetime of a study and the accuracy, consistency and value of the assessment data will depend largely on the knowledge, experience and commitment of these individuals. To minimize the element of subjectivity and to ensure good knowledge of the assessment procedures, it is essential to train and calibrate all evaluators at regular intervals. The intensity and duration of training will



depend on the complexity of the experiment, the requirements as detailed in the Experiment Work Plan and the experience of the assessors.

An annual training and calibration session should be held even if all the evaluators were trained during previous years. Changes to guidelines and procedures should be presented and problems noted from previous assessments should be discussed and consensus reached on how to deal with them. Evaluators, no matter how experienced, should also be encouraged to calibrate themselves at least annually and compare results with colleagues to ensure that interpretations of distress, degree and extent are consistent.

The training and calibration program for evaluators should include the following:

- An overview of the objectives of all experiments together with a brief description of the data processing procedures that will be used and potential applications of the final results. Specific issues related to the pavement preservation experiments and how they should be assessed and documented should also be presented.
- An overview of the causes of the various types of distress that might be encountered. It is essential that the evaluators understand the causes of the problems in order to make an accurate rating and, if applicable, to list recommendations on potential corrective action.
- An overview of the method of assessment, including descriptions of various types of distress and ratings for each type. The use of color slides to show examples is recommended. The visual

assessment manual and any other relevant guidelines and documentation should be studied by all before the training session.

- An overview of the format of the assessment sheet.
- Practical training, assessing at least 10 road segments, preferably in different conditions exhibiting a full range of defects. The method of rating should be discussed on the first segment which should then be rated jointly with further discussion until agreement and understanding is reached. Each assessor should then evaluate each of the remaining segments individually without discussion with other assessors. The assessment forms should then be compared afterwards and any major discrepancies should be discussed. If necessary, more segments should be assessed and discussed individually until acceptable consistency of rating is achieved.

It is recommended that, during the practical training, those attributes for which estimates of actual depths, lengths, widths and sizes are required should be physically measured to enhance/check the capability of accurate quantitative assessment.

In addition, it is advisable for each Project Engineer to meet with all the assessors within days after the start of the formal assessment to check the initial assessments.

It is essential that evaluators go through this process of training prior to any monitoring exercise. Post-assessment calibrations have shown that where assessors were inadequately trained, the assessment has had to be redone.

### **7.3. Operational Issues**

There are numerous operational issues that need to be taken care of prior to undertaking a monitoring evaluation, including notifications, traffic closures and equipment preparation. These will differ between Districts and between experiments and are not covered in detail in this guideline. An example checklist (Checklist 12) is provided in Appendix B.

#### **7.3.1 Notifications**

All requirements of the Caltrans Maintenance Manual regarding notifications relevant authorities, organizations and individuals should be adhered to.

#### **7.3.2 Equipment**

All requirements of the Caltrans Maintenance Manual pertaining to equipment and equipment operation should be adhered to.

### 7.3.3 Road Closures and Traffic Control

All requirements of the Caltrans Maintenance Manual concerning road closures and traffic control should be adhered to.

Checklists should be used to ensure that all operational issues are dealt with in a timely manner.



### 7.4. Monitoring Timetable

The monitoring timetable will be detailed in the Experiment Work Plan. When preparing this timetable, it is important to have a balance between collecting sufficient data and collecting too much. It is also important to identify an expected end point for the experiment, either linked to:

- Time (e.g., exceeds expected design life in years),
- Traffic (e.g., cumulative vehicles passed or exceeds expected design life in axles), or
- Failure criteria (e.g., rut depth).

A timetable with long periods between visits could result in missed opportunities to understand the ultimate mode of failure, when the onset of deterioration started and what caused it. Interest and momentum could also be lost by the project team. Conversely, a timetable with frequent monitoring visits will be expensive and will lead to repetitive data being collected. Interest and momentum could also be lost if the project team consistently has nothing new to report.

Monitoring frequency will depend on the type and objectives of the study. At least one and preferably two monitoring visits (i.e., seasonal) per year should be planned to ensure that sufficient data is collected and that the onset of deterioration is fully understood and documented. More frequent monitoring may be required initially if there is little understanding of potential longer-term performance (e.g., new pothole patch products). Issues that need to be considered include, but are not limited to:

- Seasonal factors - If it is likely that performance will change between wet and dry or warm and cool seasons, monitoring should be scheduled for the end of each relevant season. Depending on the type of strategy, special visits may also be required after significant temperature or precipitation events.
- Temperature - If diurnal variation in temperature is likely to influence performance, then repeated daily monitoring for short periods (e.g., a week) should be carried out at predefined intervals such as end of summer and winter or spring and fall.
- Moisture - If the treatments are potentially moisture sensitive, experiments will need to be monitored after significant precipitation events as well as at the end of the wet season. The monitoring team may need to visit the site at very short notice.

- Traffic - monitoring can be linked to cumulative traffic that has passed over the section and would thus be linked to information from a traffic counting or weigh-in-motion station.
- Time - if there are no specific defining factors, monitoring intervals can be simply linked to time (e.g., 3, 6, or 12 month intervals). Where possible, it is recommended that time intervals should still be linked to seasons.

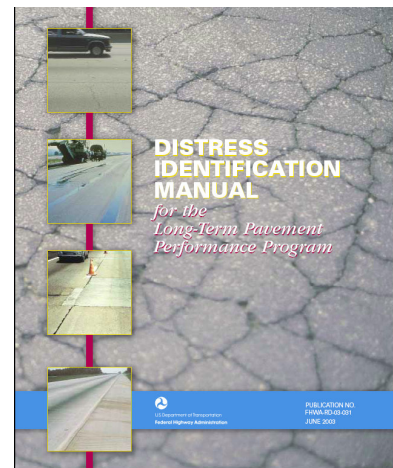
A phased approach can also be followed if there is uncertainty in determining the optimum monitoring frequency. This would entail more regular visits in the initial stages of the experiment until patterns are observed, after which the frequency is reduced. Alternatively, a rapid evaluation (e.g., drive by) can be undertaken on a frequent basis (e.g., monthly) to check if deterioration has started with more thorough evaluations being undertaken at six or twelve monthly or even longer intervals.

The Project Engineer will be responsible for ensuring that evaluations are undertaken according to the timetable. Planned evaluations should be scheduled and notifications and arrangements should be made well in advance to ensure that no delays occur at the chosen time. The Database Manager can assist by setting flags in the database and sending reminders to the Project Engineer.

## 7.5. Protocols and Criteria

The protocols and criteria that need to be used as a basis for monitoring will be detailed in the Experiment Work Plan.

Visual assessments will typically be carried out using the Caltrans Visual Condition Survey Manual. If more detail is required for analysis purposes, the LTPP Distress Identification Manual can be used. If the treatment types are new to California and thus not adequately covered in the Condition Survey Manual, then criteria will need to be set. If the technology is being introduced from another state or country, then condition survey manuals, visual assessment guides, etc, used there should be considered for the assessment. The relevant Caltrans or ASTM methods should be followed for measuring functional parameters such as ride quality, skid resistance, spray, and noise.



### 7.5.1 Failure Criteria

It is important to establish and understand what the failure criteria for any experiment are and what action needs to be taken when failure occurs. Examples of failure criteria, based on California requirements, that can be used in assessing pavement preservation experiments include, but are not limited to:

- Chip seals and overlays
  - Crack severity and extent (e.g., >2.5 m [6.5 ft] total length or 2.5 m/m<sup>2</sup> [6.5 ft<sup>2</sup>] total crack density)
  - Rut depth (e.g., > 12.5 mm [0.5 in])
  - Stone loss (e.g., > 20% of area)
- Reinforcement materials
  - Reflective cracking (e.g., >2.5 m/m<sup>2</sup> [6.5 ft] total crack density, >3 mm [0.1 in] width)
  - Rut depth (e.g., >25 mm [1.0 in])
- Crack and joint sealants
  - Spalling (e.g., >100 mm [4 in] wide)
  - Separation and/or shrinkage (>3 mm [0.1 in])
  - Whip off (>25 mm [1.0 in])
- Pothole repair materials
  - Deformation (e.g., >25 mm [1.0 in])
  - Cracking (e.g., > 10% of area)
  - Separation and/or shrinkage (e.g., >3 mm [0.1 in])
  - Punch outs (any)

Depending on the type of experiment, failure could also be determined by functional properties such as riding quality, skid resistance, spray, and noise (e.g., exceeding specified limits).

Once failure has occurred, the experiment can either be terminated or a maintenance intervention can be carried out and the monitoring continued if treatment life-cycles are being assessed.

### 7.5.2 Reference Standards

- Pavement Condition Survey Manual
- LTPP Distress Identification Manual

## 7.6. Visual Assessment



Visual assessments should be carried out on each section or panel according to the criteria detailed in the Experiment Work Plan and using the protocols described above. Prior to each evaluation, the previous evaluation forms should be reviewed in order that the evaluator can familiarize him/herself, be able to identify new deterioration, and distinguish between deterioration that occurred prior to and after the previous monitoring visit.



## Output

Completed visual assessment form.

### 7.6.1 Reference Standards

- Pavement Condition Survey Manual
- LTPP Distress Identification Manual

## 7.7. Measurements

Quantitative measures are always more useful than subjective observations when analyzing data collected from an experiment. Where feasible, any component of the process being assessed that can be physically measured should be measured with appropriate calibrated equipment and the data recorded, either on an appropriate form, or electronically depending on the parameter and the equipment used.

Parameters that need to be measured during the visual assessment will differ depending on the type and objectives of the experiment. Some examples of physical measurements on different pavement preservation experiments are listed in Table 7.3.

**Table 7.3: Examples of physical measurements**

Measurement	Total surface treatment	Selective treatment	Method
Cracking <ul style="list-style-type: none"><li>• Fatigue</li><li>• Block</li><li>• Longitudinal</li><li>• Reflection</li><li>• Transverse</li><li>• Corner</li><li>• Durability</li></ul> Crack seal <ul style="list-style-type: none"><li>• Shrinkage</li></ul>	<ul style="list-style-type: none"><li>✓</li><li>✓</li><li>✓</li><li>✓</li><li>✓</li><li>✓</li><li>✓</li></ul> -	<ul style="list-style-type: none"><li>-</li><li>-</li><li>-</li><li>-</li><li>-</li><li>-</li><li>-</li></ul> ✓	Tape measure, wheel, digitized photo Tape measure, wheel Tape measure, wheel Tape measure, wheel, digitized photo Tape measure, wheel Tape measure Tape measure, wheel Tape measure, steel ruler
Surface Deformation <ul style="list-style-type: none"><li>• Rutting</li><li>• Shoving</li><li>• Potholes</li><li>• Patch deterioration</li><li>• Patch shrinkage</li><li>• Patch deformation</li></ul>	<ul style="list-style-type: none"><li>✓</li><li>✓</li><li>✓</li><li>-</li><li>-</li><li>-</li></ul>	<ul style="list-style-type: none"><li>-</li><li>-</li><li>✓</li><li>✓</li><li>✓</li><li>✓</li></ul>	Straight edge and wedge Straight edge and wedge Straight edge and tape measure Straight edge and tape measure Tape measure, steel ruler Straight edge and wedge
Surface Defects <ul style="list-style-type: none"><li>• Bleeding</li><li>• Raveling/stone loss</li><li>• Scaling</li><li>• Popouts</li></ul>	<ul style="list-style-type: none"><li>✓</li><li>✓</li><li>✓</li><li>✓</li></ul>	<ul style="list-style-type: none"><li>✓</li><li>✓</li><li>-</li><li>✓</li></ul>	Tape measure, wheel Tape measure, wheel Tape measure, wheel Straight edge and tape measure
Miscellaneous Distresses <ul style="list-style-type: none"><li>• Blowouts</li></ul>	<ul style="list-style-type: none"><li>✓</li></ul>	<ul style="list-style-type: none"><li>✓</li></ul>	Straight edge and tape measure



Measurement	Total surface treatment	Selective treatment	Method
Joint Deficiencies <ul style="list-style-type: none"> <li>• Joint seal shrinkage</li> <li>• Faulting</li> </ul>	- ✓	✓ ✓	Tape measure, steel ruler Tape measure, steel ruler
Functional <ul style="list-style-type: none"> <li>• Longitudinal profile</li> <li>• Riding quality</li> <li>• Skid resistance</li> <li>• Noise</li> <li>• Permeability</li> <li>• Spray</li> </ul>	✓ ✓ ✓ ✓ ✓ ✓	✓ ✓ ✓ ✓ ✓ -	Laser profilometer Laser profilometer Skid tester, Pendulum tester Noise tester Permeameter Spray meter or photographs
Structural <ul style="list-style-type: none"> <li>• Deflection</li> <li>• In situ strength</li> <li>• Modulus</li> <li>• Layer thickness</li> </ul>	✓ ✓ ✓ ✓	- - ✓ -	Falling Weight Deflectometer (FWD) Dynamic cone penetrometer (DCP) FWD, Seismic Ground penetrating radar (GPR)



Permeability and Pendulum skid testing



DCP testing



Laser profilometer



Noise measurement

### Output

Completed visual assessment form. Data files for electronically collected data.

### 7.7.1 Reference Standards

- Pavement Condition Survey Manual
- Equipment manufactures' manuals

## 7.8. Failure Investigations

If a failure has occurred on a section, the cause should be identified and documented. A forensic investigation should be considered if the cause cannot be determined with confidence, for example, excessive stone loss on a chip seal, or rutting after the application of a fog seal. Forensic investigations are discussed in Chapter 8.

## 7.9. Sampling

The need to collect samples from a section will depend on the type and objectives of the experiment and will be detailed in the Experiment Work Plan. Typical samples that might be taken include, but are not limited to:

- Cores or blocks
- Loose aggregate
- Crack or joint sealant
- Pothole filler



If required, representative samples should be taken as detailed in the Experiment Work Plan. A sample log should be kept with details on:

- Sample number
- Date and time that the sample was taken
- The exact location from where the sample was taken (using X, Y, and Z coordinates)
- Sample description
- Name of the person who took the sample
- Where and under what conditions the sample was stored
- Where the sample was sent to and when
- Name of the sample owner

An example of a sample log is provided in Appendix D.

All samples should be appropriately labeled with at least the following. An example of a sample label is provided in Appendix E:

- Experiment and section number

- Sample number (linked to sample log discussed above)
- Date
- Sample owner
- Destination

All sample details should also be recorded on the Assessment Form.

An overview of sampling procedures is provided in Chapter 8.

### Output

Completed sample detail forms

#### **7.9.1 Reference Standards**

- Caltrans Construction Manual
- California methods for sampling highway materials and products used in the roadway structural sections

#### **7.10. Forensic Studies**

Forensic studies are discussed in Chapter 8.

#### **7.11. Checklists**

All relevant issues will be listed on the monitoring checklist, which must be signed off by the Project Engineer(s) on completion of construction. Examples of the checklists relevant to this chapter are provided in Appendix B.

#### **7.12. Quality Management**



Quality management issues pertaining to the roles and responsibilities described in this chapter include:

- Understanding the monitoring requirements of the Experiment Work Plan
- Training and calibrating evaluators
- Conducting visual assessments and measuring specified parameters at the intervals and to the requirements detailed in the Experiment Work Plan
- Sampling all relevant materials at the time and to the requirements specified in the Experiment Work Plan
- Completing all relevant checklists, forms and labels

### **7.12.1 Quality Control**

Depending on who undertakes the assessment, an independent review should be undertaken by the Project Engineer, Project Champion or other suitable individual to ensure that evaluations are being carried out consistently and according to the requirements of the Experiment Work Plan. Individuals undertaking the quality assessments should attend the training and calibrations session together with the evaluators.

Quality control assessments should be carried out within one week of the original assessment. Evaluators should not be informed that a follow-up assessment is going to be undertaken. The results of the original and quality control assessments should be compared and there should be no difference in the severity and extent ratings of the key distress types being assessed. It should be noted that, due to the subjective nature of visual assessments, the practitioner undertaking the quality control assessment might not necessarily be correct. If there is variation in two assessments, the assessment forms should be compared to determine where the discrepancy occurs. If it is derived from the entire assessment, the evaluator and quality controller should visit the site to understand the discrepancy. If the fault lies with the evaluator, the assessment will have to be repeated. The evaluator should either be replaced or retrained. If a proprietary product is being assessed, the supplier should be invited to participate in assessments.

### **7.12.2 Data Management**

The bulk of the data for the experiment will be collected during the monitoring phase of the experiment. Data should be recorded on appropriate forms designed to meet the needs of the experiment. Examples of forms are provided in Appendix D. Mandatory information should include:

- Name of evaluator
- Date
- Route number
- County/district
- Section name and number
- Signature of evaluator
- Signature of person performing quality management

All documents should be added to the Project File. In order to facilitate later data analysis, all data from the forms should be captured into a spreadsheet as soon as possible after monitoring (i.e., one week). Timely capture will allow checks to be made and any missing data to be collected within a short period after the assessment, or while the visit is still clear in the Engineer's mind. A copy of the spreadsheet, named according to the experiment naming format described earlier, plus date, should be forwarded to the Database Manager.

### **7.12.3 Responsibility**

The Project Engineer is responsible for:

- Monitoring the experiment, or delegating an evaluator to do the monitoring. If an evaluator is appointed, the Project Engineer retains overall responsibility for ensuring that that evaluation is carried out at the correct time and according to the requirements of the Experiment Work Plan.
- Reviewing and approving all evaluations undertaken by the appointed evaluator
- Conducting first level checks to compare the evaluation with previous evaluations to ensure consistency in results
- Ensuring that the forms and other relevant documentation are sent to the Database Manager
- Ensuring that any samples collected reach the laboratory, are tested as per the Experiment Work Plan, and that the results are forwarded to the Database Manager.
- Maintaining the Project File

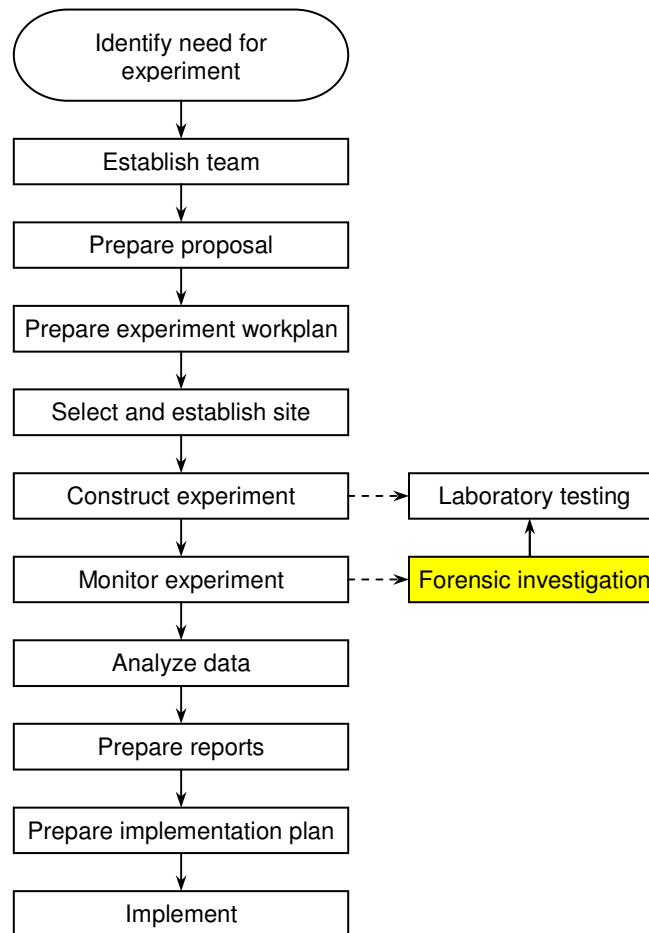
The Database Manager is responsible:

- Setting flags for evaluation dates in the database and forwarding reminders to the Project Engineer
- Capturing the data in the database

The Project Champion is responsible for approving all checklists.

## 8. FORENSIC INVESTIGATIONS

---



### 8.1. Introduction



Forensic investigations should be undertaken to confirm the mode of and reason for failure on any experiment. They should also be considered as a final opportunity to rigorously study the section, the findings of which could contribute significantly to understanding how the various treatments performed. Most forensic evaluations on pavement preservation treatments will simply involve a close-out evaluation. If the reason for failure cannot be determined with certain, a more detailed forensic investigation by means of cores and/or test pits may be required. Although opening a pit at every experimental section would be desirable (and many would say essential) from a data collection and project completeness point-of-view, a number of factors should be considered before carrying out such an extensive study. These include:

- Value of the data in complementing that already collected - a forensic investigation cannot be justified if no additional contribution to learning or to the database is made above that obtained from routine monitoring of the section. A guide for detailed forensic investigations is provided in Table 8.1.
- Cost of the assessment - program funding may not accommodate a forensic investigation at each site
- Disruption to traffic - at least one lane will need to be closed to traffic for the duration of the forensic investigation and repair of the core holes and or pits
- Impacts on the safety of workers and road users during the lane closure
- Potential problems during and after repair resulting from consolidation and seepage of moisture into the pavement layers

The need for a destructive forensic investigation on any section should therefore be carefully weighed against the potential usefulness of the data that can be collected. A destructive forensic investigation is probably not justified if the root cause of any distress, its extent and its consequences on any section can be satisfactorily determined from the data already collected during monitoring evaluations. Furthermore, the project team needs to question whether or not any additional information gathered from coring or a test pit will significantly add to the understanding of how that pavement is behaving/performing. Conversely, if the section behavior/performance cannot be adequately explained or if pertinent data (e.g., pavement structure) is missing from the database or is questionable, a forensic investigation may be justified.

**Table 8.1: Forensic investigations associated with pavement preservation activities**

Activity*	Detailed forensic required?	Test pit + cores	Cores only
Thin overlays	Yes, if rutting & cracking present	✓	-
Ultra-thin overlays	Yes, if rutting & cracking present	✓	-
Bonded wearing course	Dependent on failure mechanism	✓	✓
Microsurfacing	No, unless deformation recorded after application	-	✓
Chip seals	No, unless deformation recorded after application	-	✓
Slurry seals	No, unless deformation recorded after application	-	✓
Fog seals	No, unless deformation recorded after application	-	✓
Crack seal	No	-	✓
Crack fill	No	-	✓
Joint seal	No	-	✓
Patching	Dependent on type of failure	✓	✓
Partial-depth concrete repair	No	-	✓
Full-depth concrete repair	Dependent on type of failure	✓	✓
Edge repair	No	-	✓
Diamond grinding	No	-	✓
Dowel bar retrofit	No	-	✓

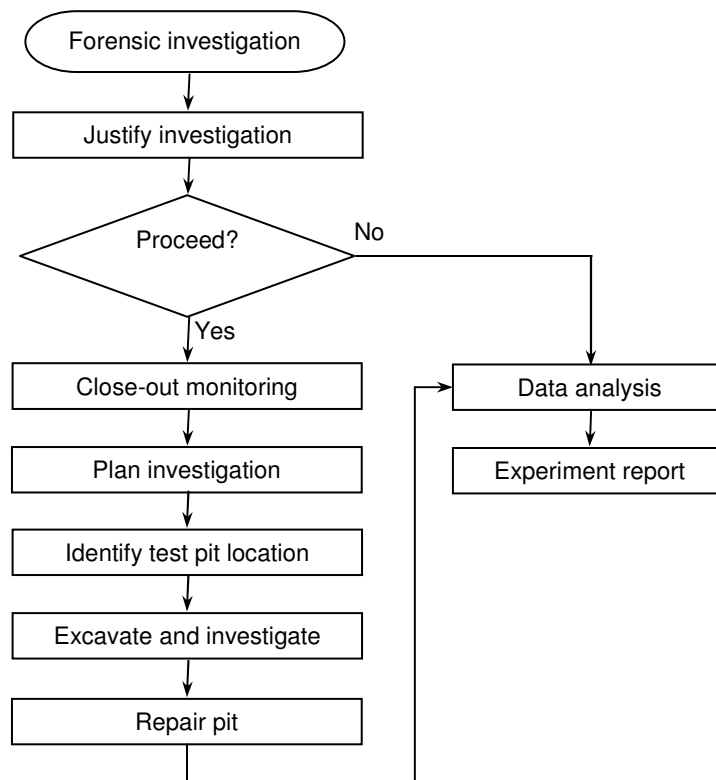
In this chapter, the level of detail, test pit location, coring, test pit excavation, sample logistics, test pit logging, in-pit testing and test pit repair are discussed. A flowchart summarizing the chapter is provided in Figure 8.1.

## 8.2. Record of Decision

The decision to undertake a forensic investigation for any experiment should be recorded in the Experiment Work Plan. Details in the work plan should include:

- Reason for undertaking a forensic investigation together with expected benefits of the additional data
- Level of detail and justification
- Responsibility for the investigation

A copy of the record of decision should be added to the Project File.



**Figure 8.1: Flowchart for forensic investigations**



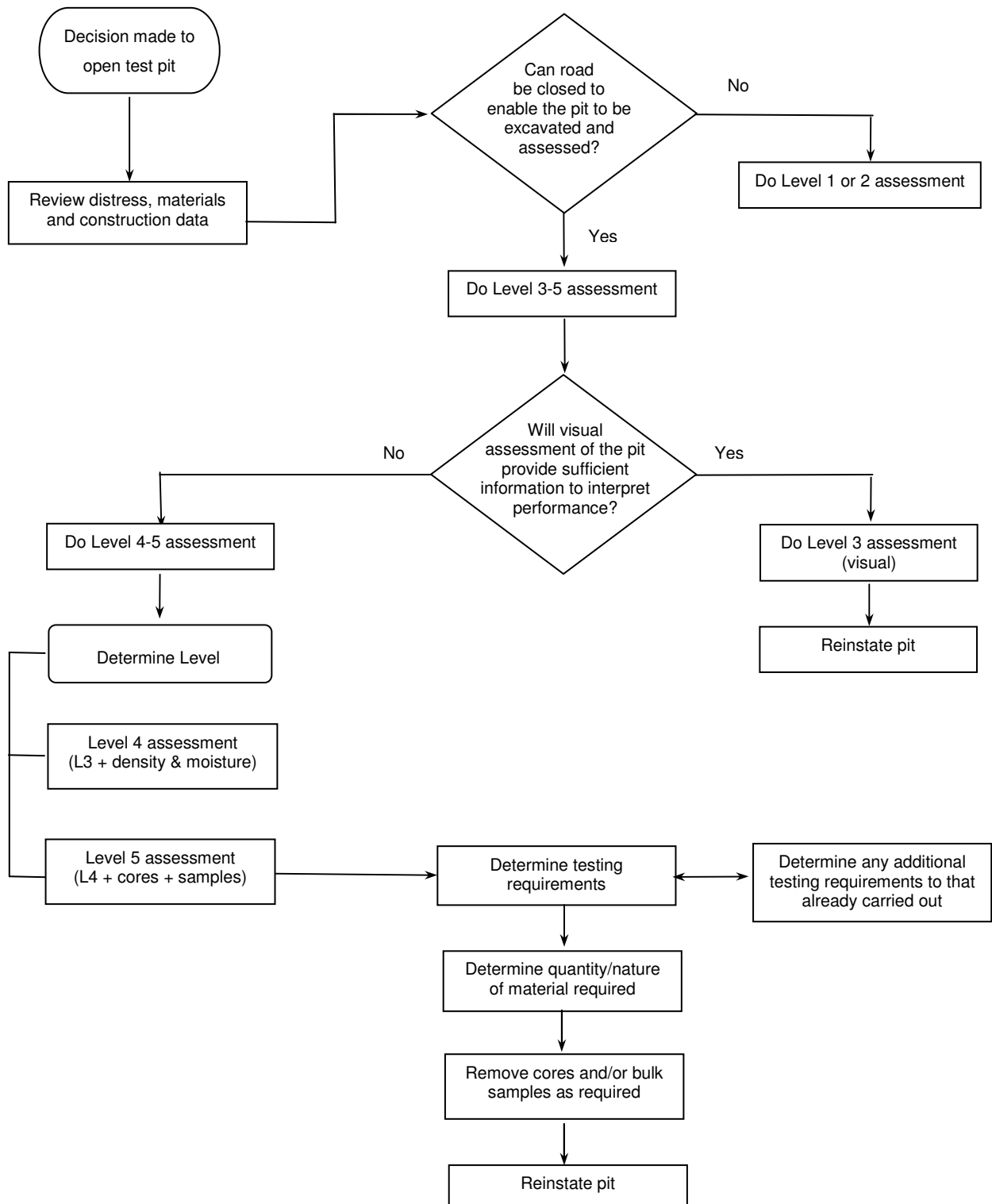
### 8.3. Level of Detail

Once a decision is made to proceed with a forensic investigation on a particular experiment, the level of detail required and the need for coring and/or bulk sampling of materials will then need to be determined.

Typical levels are:

- Level 1 Visual assessment as per monitoring evaluation. Samples of raveled stone from a chip seal, for example, may be collected for closer analysis and laboratory testing. Laboratory testing may also be required on materials collected during construction.
- Level 2 150 or 304 mm (6 or 12 in) core log, with layer descriptions and thicknesses and photographs. This level of forensic investigation would be carried out if the failure is restricted to pavement preservation treatment and immediate underlying layer, or if disruptions to traffic are a major concern. The cores can be removed and holes repaired with considerably less disruption than the opening of a pit. Assessments will probably be limited to bound layers only, as unbound layers tend to disintegrate when extracted.
- Level 3 Test pit log and description with photographs. This level of investigation is carried out to fully describe the pavement structure and distress through the structure. No additional testing is carried out and where possible, materials are reinstated. If the effort is being made to open a test pit, serious consideration should be given to at least obtaining accurate moisture measurements in the different layers (i.e., Level 4 investigation)
- Level 4 Level 3 together with gravimetric moisture determinations, density and dynamic cone penetrometer (DCP) measurements through the unbound layers and subgrade (optional). Moisture and density data allows comparison with as built data and can be used to assess the influence of these parameters on performance as well as the influence of distress on the parameters (e.g., moisture ingress through cracks). DCP measurements provide a simple indicator of layer thicknesses and strength, which can be interpreted together with the test pit log and moisture and density data and compared with deflection and ground penetrating radar measurements. Although DCP measurements may not be appropriate for the very strong pavement layers in the experiment, they could provide useful information on the condition of the subbase and subgrade.
- Level 5 Level 4 together with cores for assessment of asphalt concrete and portland cement concrete layers and bulk samples for grading and Atterberg Limit tests. This level of forensic investigation is required if additional testing of the surface and supporting layers is required.

The level of detail will influence the cost of the forensic investigation and the time that the road is closed to traffic. Guidance on determining the level of detail required is provided in the flow chart in Figure 8.2.



**Figure 8.2: Flowchart for determining level of detail of the forensic investigation**

## 8.4. Close-Out Monitoring

A complete, final evaluation of the section should be carried out prior to undertaking the forensic study. Data should be recorded on the same Assessment Form used throughout the study.

## 8.5. Level 1 Forensic Assessments

Level 1 forensic assessments should be carried out according to the procedures discussed in Chapter 7. Where necessary, samples may need to be collected to determine the cause of failure. Typical examples of Level 1 forensic assessments and the associated tests include, but are not limited to:

- Chip seal failure due to stone loss. Forensic investigation will assess binder/aggregate compatibility, design versus actual binder and aggregate application rates, aggregate durability, and environmental influences.
- Chip seal failure due to bleeding/embedment. Forensic evaluation will assess chip seal design method, binder application rate, condition of surface prior to sealing, effect of tack coat and/or binder on the existing wearing course binder, construction procedures (binder temperature, compaction, etc), and environmental influences.
- Slurry seal failure due to ravelling. Forensic evaluation will assess slurry design, homogeneity of the slurry, surface preparation, construction procedures, binder suitability, and environmental influences.
- Crack seal, crack fill and joint seal failure due to debonding. Forensic evaluation will assess durability of the sealant, sealing process (e.g., was the crack/joint adequately cleaned), shrinkage, post sealing cracking, chemical analysis of the failed sealant compared to sample collected at beginning of experiment, and environmental influences.
- Pothole repair failure due to water ingress. Forensic evaluation will assess permeability of the patch compared to surrounding surfacing, shrinkage, traffic compaction, patching procedures, and traffic and environmental influences.

## 8.6. Test Pit Location

Forensic investigations should only be carried out once an experiment has been completed so that test pits can be located within the test section without influencing later evaluations. Wherever possible, a “good” and “bad” section within the same experiment should be compared to maximize the understanding of how the pavements behaved. If forensic investigations are required for a specific reason prior to completion of evaluations, the test



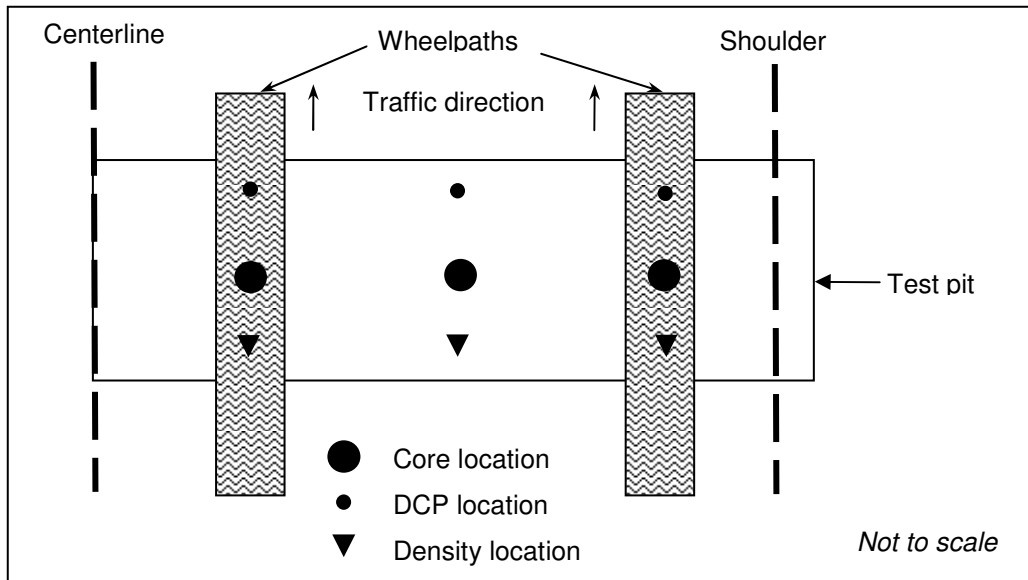
pit should be located in an undisturbed area of one of the destructive testing sections before or after the experimental section.

No previous excavation should have taken place at the selected test pit site.

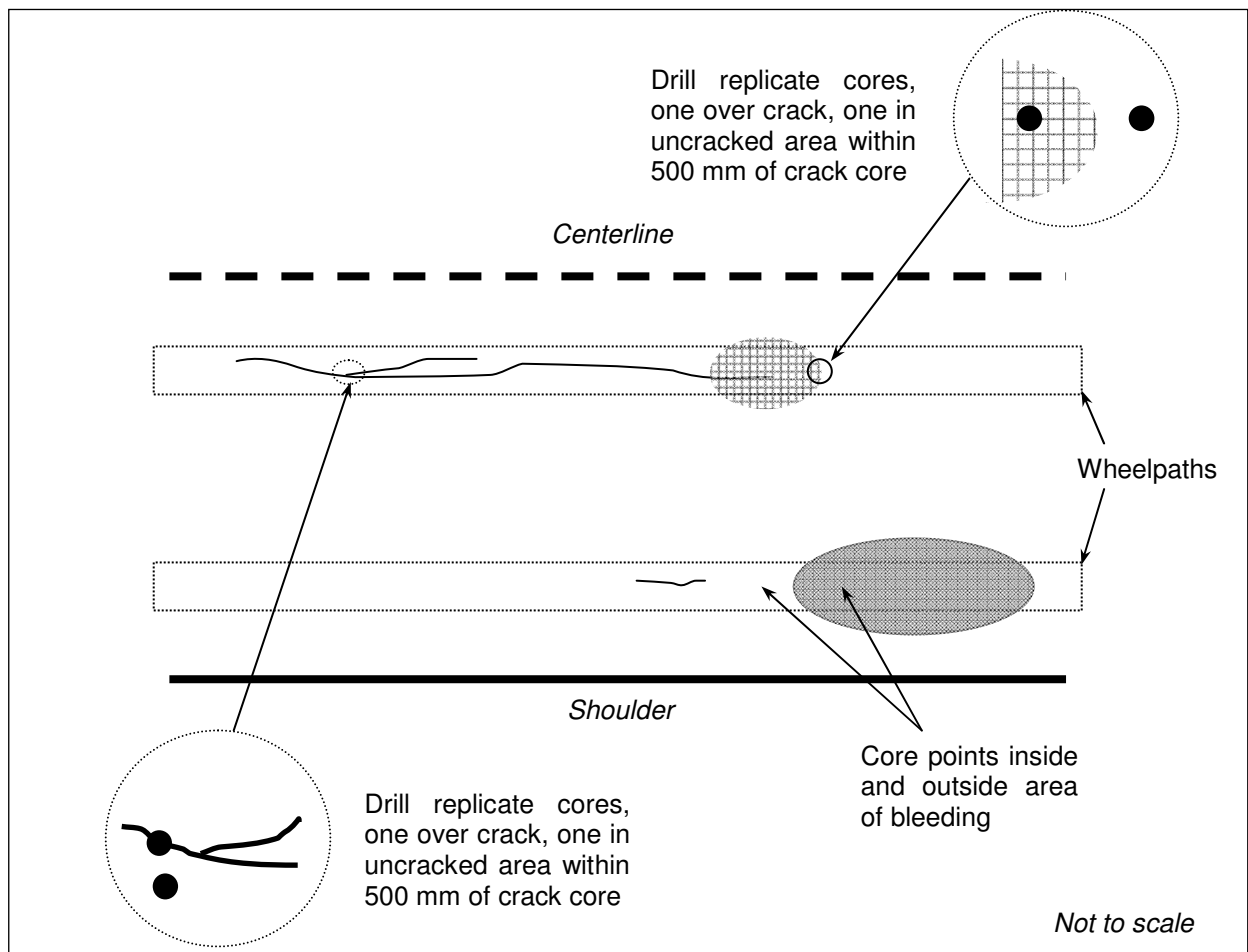
The following procedure for identifying the test pit location should be followed.

- Walk the entire section in both directions and identify potentially suitable locations that are representative of the section.
- Select the most suitable site. If no clear choice can be made, the center of the section should be selected. Mark out the pit extremities from the mid-point of the sealed shoulder to the centerline, or at least to a point midway between the inner wheel path and the centerline if there are concerns about working too close to the adjacent trafficked lane. The test pit should be as long as is necessary to meet this requirement, 1.2 m (4 ft) wide and deep enough to expose the top 150 mm (6 in.) of the subgrade. Schematics of the test section and test pits are provided in Figure 8.3.
- Depending on the level of detail selected, mark out locations for core holes, density measuring points and DCP tests. Core hole locations for verifying pavement layer thicknesses should be marked at each of the FWD positions in the section (see Section 5.4). Additional core hole locations for closer investigation of distress and joint seals should be marked at an appropriate place on the distress (e.g., across a crack, in area of severe chip seal stone loss, etc.). Consideration should also be given to removing a core from an adjacent area with no distress for comparison purposes and suitable locations should be marked. Examples are provided in Figures 8.4 and 8.5.
- Capture relevant information on a Forensic Investigation Site Report (example Form 5 in Appendix D) and prepare a schematic of the test section and test pit location for record purposes (Form 6 in Appendix D).
- If a 304 mm (12 in.) core is removed as an alternative to a test pit for the forensic investigation (i.e., Level 2), the drilling site should be located within an area of distress where additional information is required or, if no particular area is identified, across the outer wheel track at the center of the section.

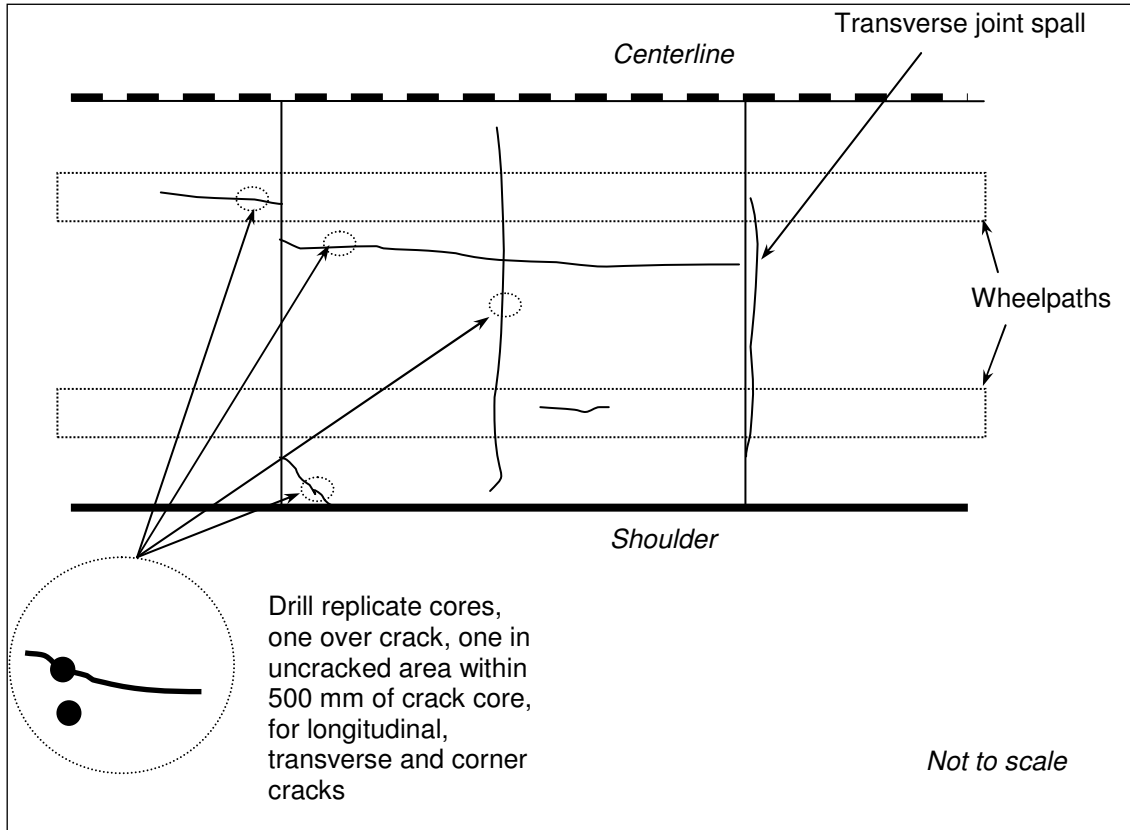




**Figure 8.3: Test pit layout**



**Figure 8.4: Examples of core locations on asphalt concrete sections**



**Figure 8.5: Examples of core locations on portland cement concrete sections**

## 8.7. Coring

All cores should be removed from the marked locations on the section prior to excavation of a test pit (Figures 8.3 through 8.5). If additional material, in the form of cores, is required to supplement material previously sampled from the experiment, these should be removed from the required zones of the section or from the test pit area, depending on the number of samples that is required. Alternatively, cores can be taken from the sawn slab at a later date.



### 8.7.1 Reference Standards

The following reference standards are applicable to coring activities at forensic investigations:

- AASHTO R 13 - "Conducting geotechnical subsurface investigations"
- AASHTO T 24 - "Obtaining and testing drilled and sawed beams of concrete"
- AASHTO T 225 - "Diamond core drilling for site investigation"

- AASHTO T 310 - “In-place density and moisture content of soil and aggregate by nuclear methods (shallow depth)”
- ASTM D 2488 - “Description and identification of soils (visual-manual procedure)”
- ASTM D 4083 - “Description of frozen soils (visual-manual procedure)”
- ASTM D 4220 - “Preserving and transporting soil samples”
- ASTM D 5195 - “Test method for density of soil and rock in-place at depths below the surface by nuclear methods”

Motorist and worker safety during coring are of major concern and appropriate measures need to be taken as prescribed in Section 7.3 (Operational Issues).

### 8.7.2 Equipment

A diamond bit coring drill should be used to remove cores. Mist-cooled equipment is typically used in California. If moisture damage is a potential cause of the failure being investigated, air-cooled coring equipment should be used. The size of the core will depend on the testing that is required [e.g., 100 mm (4 in.) or 152 mm (6 in.)]. A 304 mm (12 in.) core should be removed for Level 2 forensic investigations. This core can be replaced after the assessment has been completed and photographs have been taken.

Supporting equipment shall include devices for assistance in removal of the cores and patching of the road.

### 8.7.3 Procedure

Cores shall be taken at an angle of 90° to the surface in such a way as to ensure the recovery of straight, intact smooth -surfaced samples suitable for laboratory testing.

All cores of pavement surfaces shall be marked on the top with an arrow to show the direction of traffic prior to removal of the cores from the pavement. The marking material shall be waterproof so as to remain clearly visible after coring operations.



A separate log shall be prepared for each core hole. The depth of penetration of each coring operation, the average length of the recovered core and the pavement layer thicknesses that can be distinguished, shall be recorded to the nearest 1.0 mm ( $\pm 1/10$  in.). Data sheets for logs are included in Appendix D (Form 7). Remarks shall include type of cooling medium, difficulties encountered in coring, and defects (such as cracks, voids, and disintegration) observed in the core.



#### 8.7.4 Core Logging

Cores should be logged using the same criteria as that used for test pits. Test pit logging is described in Section 8.9.

### 8.8. Test Pit Excavation

This activity involves test pit excavation of the asphalt concrete, portland cement concrete, treated and untreated base, subbase, and subgrade layers of pavements.

#### 8.8.1 Reference Standards

The following reference standards are applicable to test pit excavation activities at forensic investigations:

- AASHTO R 13 - “Conducting geotechnical subsurface investigations”
- AASHTO R 19 - “Operational guidelines on test pits for evaluating pavement performance”
- AASHTO T 24 - “Obtaining and testing drilled and sawed beams of concrete”
- AASHTO T 310 - “In-place density and moisture content of soil and aggregate by nuclear methods (shallow depth)”
- ASTM D 2488 - “Description and identification of soils (visual-manual procedure)”
- ASTM D 4083 - “Description of frozen soils (visual-manual procedure)”
- ASTM D 4220 - “Preserving and transporting soil samples”
- ASTM D 5195 - “Test method for density of soil and rock in-place at depths below the surface by nuclear methods”

Motorist and worker safety during test pit excavation, sampling, and testing are of major concern and appropriate measures need to be taken as prescribed in Section 7.3 (Operational Issues).

#### 8.8.2 Equipment

The equipment needed includes a pavement saw (mist or air cooled), suitable excavation machine, jack hammer (pneumatic pavement breaker and chisel), and a dump truck. Supporting equipment shall include devices for assistance in removal of pieces of pavement and properly loosening and removing base, subbase and subgrade layers. Hand labor will be required to complete excavation to avoid damaging layers with power equipment and to avoid layer contamination. Equipment for pit repair and patching must also be available. Suitable plastic containers (pots, bags, etc) should be available to seal all samples as soon as they are removed.





### 8.8.3 Procedure

The pavement shall be sawed to the full depth of the pavement surface and treated layers to the specified overall dimensions and into smaller pieces as necessary for removal. Use of cooling water during sawing shall be minimized to reduce water contamination of layers. Where possible, air cooled equipment should be used, especially if a moisture related failure is being investigated. If saws are not available of sufficient blade diameter to cut through to the base of the treated layers, pneumatic spades and chisels shall be used carefully to minimize damage to underlying untreated layers. If the need for material samples has been identified, then slabs of the pavement surface of appropriate dimensions to satisfy the testing requirements shall be recovered intact for packaging and shipment.



Test pit sawing

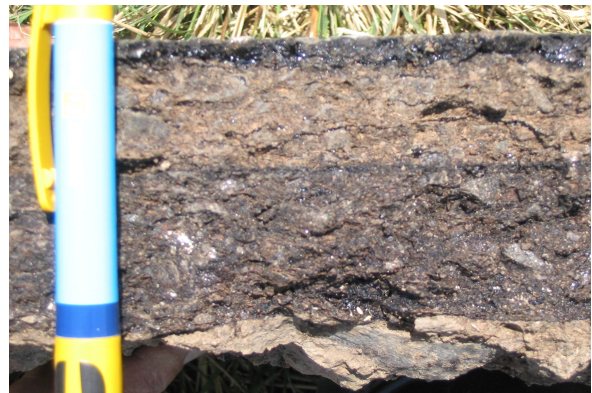


Slab removal

All slabs of pavement surfaces shall be marked on the top with an arrow to show the direction of traffic prior to removal from the pavement. The marking material shall be waterproof so as to remain clearly visible. The asphalt concrete pieces shall be retained in a cloth or plastic bag after removing any water from coring or sawing. The slabs shall be placed with the upper surface down on a wood base prior to insertion in the bag and shall be maintained in that position throughout storage prior to shipping and when packaged for shipping.



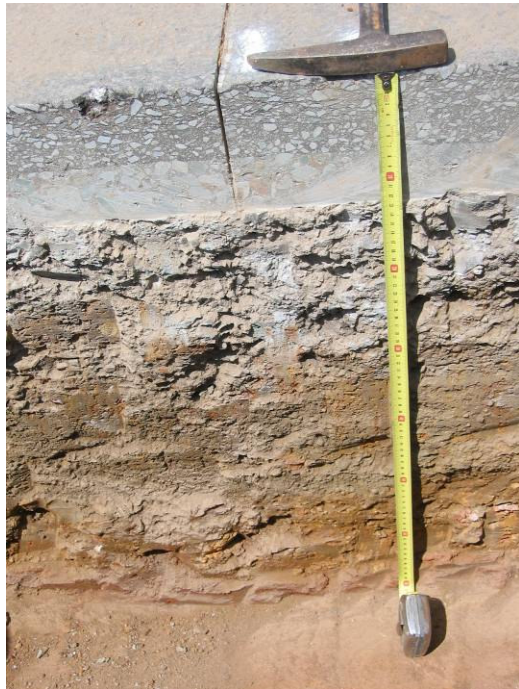
Investigation of slab underside



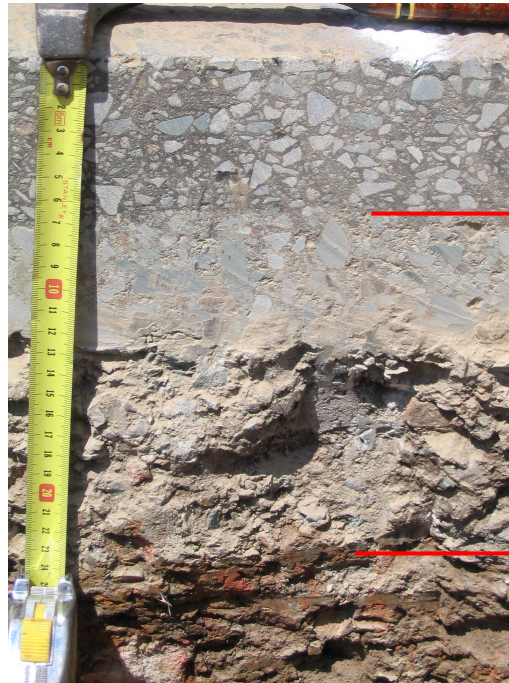
Layer assessment of slab



After removal of the surface, the base course shall be tested and sampled in accordance with the level of detail identified. The remaining base course layer shall then be carefully removed to expose the subbase and/or subgrade layers, which may also be sampled if required. Excavation shall continue to a depth of 150 mm (6 in) below the top of the subgrade or fill material. If backhoe buckets with teeth are used to excavate untreated layers, care must be exercised during the last few centimeters to avoid disturbing the underlying layer. Hand finishing of excavation of untreated layers is preferred.



Hand-finished test pit face



Surfacing

Base

Subbase

Close up of brushed pit face



Layer differentiation with string lines

Bulk samples of uncontaminated material shall be obtained from those layers in which the need for additional testing has been identified. Care must be exercised to avoid contamination of material from one layer with material from another layer. The size of the sample will depend on the testing that has been identified. Bulk sample quantities required for packaging and shipment shall typically be 150 kg ( $\pm$ 200 lb).

A 5.0 kg (11 lb) moisture sample for laboratory moisture testing shall be sampled from each layer.

#### **8.8.4 Excess Materials**

All excess materials shall be temporarily stored for use in repairing the test pit or disposed of off-site in accordance with standard requirements.

### **8.9. Marking, Packaging and Shipping**

#### **8.9.1 General Provisions**

Field preparation for shipping should be performed in accordance with ASTM D 4220, Group B, for all soil and other unbound materials. Other specific instructions for each type of sample are given below.

General requirements for marking and packaging individual samples are as follows:

- Indelible ink pens of black or other suitable color shall be used for marking labels
- Labels and tags shall be of high quality moisture resistant material
- Tins or jars with small portions of bulk samples of materials to be used for laboratory moisture content determination shall be sealed with tape against moisture loss or gain
- Bags for large bulk samples shall be heavy cloth, plastic lined with wire-tie for closing
- Samples shall be sealed in plastic if moisture loss could affect the sample, (e.g., stabilized layers, slaking materials)
- Cores shall be placed in “zip-lock” storage bags and sealed, then wrapped for their entire length with tape [e.g., 50 mm ( $\pm$ 2 in.) wide plastic transparent mailing tape]

#### **8.9.2 Sample Code Number**

Each sample (core, block, bulk, moisture) shall be assigned a five-part number that must be recorded on the sample forms for each sample collected. The sample code number will begin with the experiment number, followed by the letter “F” (for Forensic), then two letters and one number.

The second letter identifies the sample type in one of the following categories:

- C - core sample
- K - block sample
- B - bulk sample
- M - moisture sample
- P - broken pieces or chunks

The third letter identifies the type of material in the sample in one of the following categories:

- A - asphalt concrete
- P - portland cement concrete
- T - treated, bound, or stabilized base/subbase
- G - untreated, unbound granular base/subbase
- S - subgrade soil or fill material

Numbers are issued consecutively for samples starting from the shoulder and moving toward the centerline. An example of a sample number follows:

## **PPTS/3/05/1/1-F/C/A/1**

Where: PPTS/3/05/1/1 - is the experiment number (see Chapter 11)

F -	Forensic
C -	Core
A -	Asphalt concrete
1 -	First sample from shoulder

If cores of the pavement surface layer and treated base/subbase layer are extracted as one piece, no attempt should be made in the field to separate the cores into separate layers. The core should be labeled separately, packaged and prepared for shipment. Examples are cores of an asphalt concrete (AC) layer over stabilized base, an AC layer over a portland cement concrete (PCC) layer, PCC layer over AC-treated layer, PCC layer over stabilized/treated layer including econocrete, and cement treated base or subbase.

### **8.9.3 Labels and Tags**

Each sample shall be labeled before being packed and each package shall then be labeled after sealing. All labels shall be secured to the sample, containers and packages in such a manner as to prevent them becoming detached during shipment, handling and storage. As a minimum the following information should be included on tags and labels:

- Experiment and section identification number
- Sample type (e.g., AC core, Bulk sample of AC base, etc)
- Core/sample location (as marked on sample layout plans)
- Sample number
- Sample date

#### 8.9.4 Packaging

Instructions for combining the samples for shipment are as follows:

- All samples of like material (e.g., asphalt concrete surface and binder, cement treated base/subbase/subgrade) shall be placed in separate boxes or separate compartments of one box
- Each sample shall have a label or tag attached that clearly identifies the material prior to testing
- Each core shall be surrounded with “bubble-wrap” or other acceptable cushioning material on all sides within the shipping box. Tape which is used to secure the “bubble-wrap” should not touch the surface of the core
- Block samples of treated materials shall be sealed with wax on all sides, packaged in boxes with cushioning such as “bubble-wrap” or other acceptable material for shipment to the testing laboratory
- Bulk samples shall be marked with two labels or tags. One shall be placed inside the bag and one attached to the outside. A small bag or jar sample for moisture testing of each bulk sample shall be placed inside the bulk sample bag. Pieces from treated layers of coring operations not suitable for testing as cores shall be retained and packaged for shipment as bulk samples
- All shipping boxes shall be wood of suitable grade and construction to withstand shipping and subsequent moving without breakage of the box or damaging of samples
- All boxes shall be adequately secured by nails or screws prior to shipping
- Copies of the Site Report (Form 5, in Appendix D) and Material Inventory (Form 4 in Appendix D) shall be included with each shipment

#### 8.9.5 Shipping

All samples shall be shipped to the designated laboratory or storage center within five days of sampling by ground transportation. Each box shall be labeled as described in the previous section. The boxes shall also be labeled “Handle with Care” or similar wording as specified by the transporting organization to insure careful handling and protection from freezing and overheating. If required, each shipment should be insured for an amount to cover at least twice the cost of the fieldwork performed to obtain the samples.

### 8.10. Core and Test Pit Logging



Test pit logging (or core logging if a test pit cannot be excavated) is the visual assessment component of the forensic investigation. Although guidelines can be prepared for undertaking this assessment, every assessment will be different depending on the distress that has developed over time, its causes and related consequences. Therefore, each pit or core will have to be closely examined, measured, logged and photographed in a systematic manner and all observations carefully noted to ensure that data are useful for subsequent



interpretation and analysis. It must be remembered at all times that the purpose of a forensic investigation is not only to establish the cause of distress and or failure (i.e., a post mortem investigation), but also to understand how the pavement behaved and to enable comparison with other similar pavements. This information needs to be presented in such a way that researchers can make use of the data in later studies.

### 8.10.1 Reference Standards

The following reference standards are applicable to the logging of test pits and large diameter cores at forensic investigations:

- AASHTO R 13 - “Conducting geotechnical subsurface investigations”
- AASHTO T 310 - “In-place density and moisture content of soil and aggregate by nuclear methods (shallow depth)”
- ASTM D 2488 - “Description and identification of soils (visual-manual procedure)”
- ASTM D 4083 - “Description of frozen soils (visual-manual procedure)”
- ASTM D 5195 - “Test method for density of soil and rock in-place at depths below the surface by nuclear methods”

### 8.10.2 Logging Procedure

#### Timing

Logging of test pits shall be started within 15 minutes after completion of excavation, before the moisture content of the face of the test pit changes significantly. Logging of large diameter cores shall begin within 15 minutes of it being removed from the pavement.

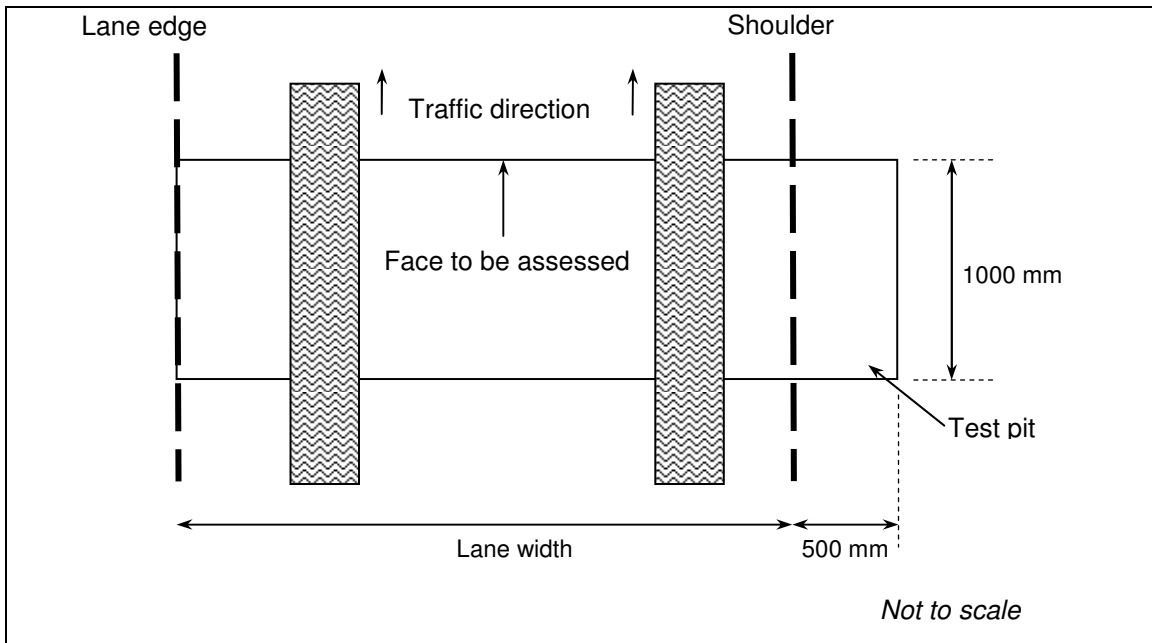
#### Assessment Zones

Layer thicknesses should be measured in each wheel path and the center point between the wheel paths on the transverse faces of the pit and at two positions (approximate thirds) of the longitudinal faces of the pit, for a total of ten measurements. If the study is being conducted on a core, layer thicknesses should be taken at the thickest and thinnest points and these positions noted in respect to the orientation of the core.

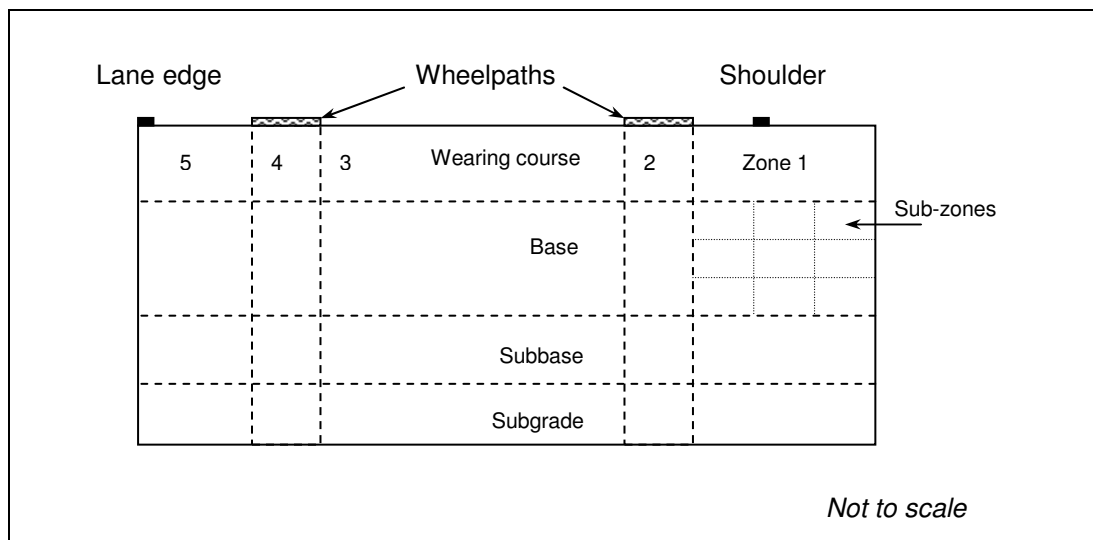
Logging should be carried out on the “front” face of the test pit relative to traffic direction (Figure 8.6). If a core is being assessed, the entire core should be checked. In order to simplify the assessment and later interpretation, the test pit face can be assessed in the following zones for each layer (Figure 8.7). If required, each zone can be further subdivided into nine sub-zones in the form of a grid to simplify the assessment procedure and provide more detail in the interpretation.



- Zone 1: Edge of test pit (shoulder) to outside edge of outer wheel path
- Zone 2: Outer wheel path
- Zone 3: Outside edge of outer wheel path to inside edge of inner wheel path
- Zone 4: Inner wheel path
- Zone 5: Outside edge of inner wheel path to edge of test pit (inside lane edge)



**Figure 8.6: Plan view of test pit face to be logged**



**Figure 8.7: Zoning of the test pit face**

### Profile Measurement

The profile of each layer interface should be measured from a string line, with special attention given to the assessment of rutting in the various layers. Nails should be driven into each layer interface at either end of the test pit on the selected face. A string should then be tied to the nails and pulled tight and level (no sag) to provide a reference line for measurements. Measurements, to the nearest 1.0 mm ( $\pm 1/10$  in), should be taken from the string line at 100 mm (4 in) intervals starting from the shoulder side of the pit and working towards the centerline. The maximum offset should also be recorded. The layer profiles and measurements should be recorded on the test pit sketch form (example Form 8 in Appendix D). Deviations from the norm, pavement design or as built records (e.g., thicker or thinner layers) should be noted.



Note rutting in underlying AC layer.



Note variable thickness of all layers.

### Procedure

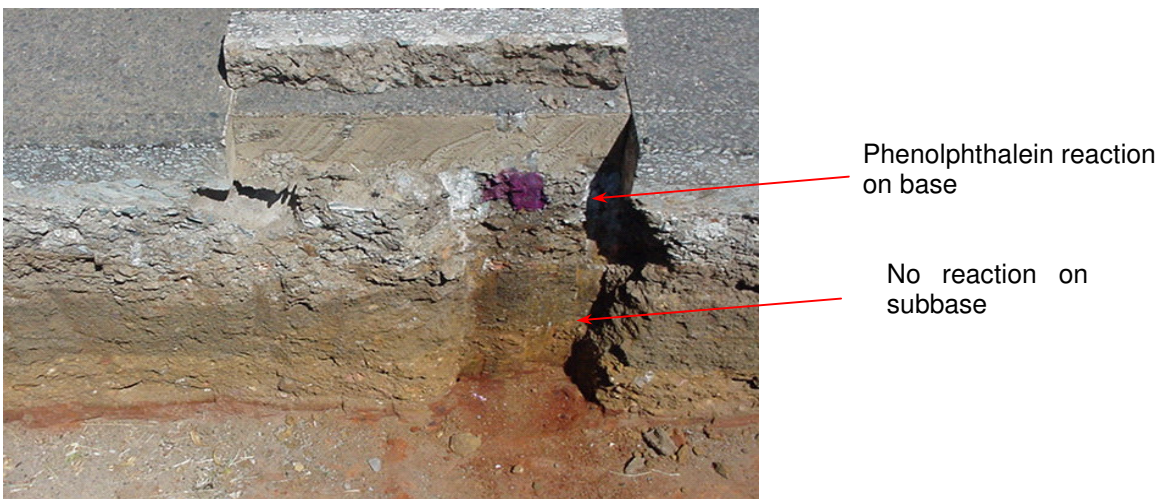
Within 15 minutes of completion of the entire excavation, the wall of the pit should be scraped with a spade. The pavement profile should then be systematically described and measured. The assessment should be recorded and checked on test pit assessment forms (example Forms 9 and 10 in Appendix D). The record shall include:

- The thickness of each layer to the nearest 1.0 mm ( $\pm 1/10$  in). Deviations in thickness from the design and as-built records should be noted together with an interpretation of what influence this deviation has had on the overall performance of the section.
- The description of each layer, in accordance with the layer designations provided on the preliminary data sheets. A summary of pertinent parameters is provided in Tables 8.2, 8.4, and 8.6. These parameters are assessed in terms of a number of criteria. It should be noted that these criteria should be used as a guide only and that the assessment should not be limited to them.
  - *Severity*: where applicable, rated on a scale of 1 (low), 2 (moderate), or 3 (high). Severity descriptors are provided in Tables 8.3, 8.5, and 8.7.



- *Extent:* describes the percentage area, number of and/or length of the parameter being assessed. Extent descriptors are listed in Tables 8.3, 8.5, and 8.7.
  - *Start:* where applicable, the start point of the defect [e.g., surface or 25 mm (1.0 in.) below subbase/base interface in Zone 1]
  - *End:* where applicable, the terminal point of the defect
  - *Layers and zones affected:* indicates which layers and zones are influenced by the parameter being assessed, listed in order from start to its terminal point
  - *Description:* describes the pertinent aspects of the parameter being assessed.
  - *Implications:* where applicable, lists the implications and consequences of the parameter (e.g., vertical crack provides a path for the ingress of water and the egress of fines) and links to other distress/attributes.
- Sample numbers and number of bags per sample
  - In-pit test numbers

Layers that have been stabilized with cement or lime should be sprayed with a phenolphthalein solution to determine whether any carbonation of the layer has occurred. Those areas of stabilized materials that do not react with the phenolphthalein solution (i.e., do not turn a dark red color) should also be sprayed with a dilute hydrochloric acid solution and the degree of any reaction (fizzing) recorded. If possible, similar material that has not been stabilized should also be checked for the acid reaction and whether the reaction is weaker or the same as the stabilized layer. This will indicate whether calcium carbonate occurs naturally in the material. Special precautions for handling phenolphthalein and hydrochloric acid should be taken and suitable protective clothing and equipment should be worn when handling the chemicals.





Phenolphthalein reaction on core



Hydrochloric acid reaction on disintegrated core

The condition and shapes of the layer interfaces should be examined to determine where rutting and other distress originates. Deep ruts at the surface not reflected at the base/subbase interface indicate that the rutting has taken place in the base course or asphalt concrete surfacing. Where the surface rut is mirrored at the base/subbase interface or the subbase/subgrade interface, the surface rutting is a consequence of compaction or shear at a depth below the interface. Shearing/movement within layers in the form of shiny shear planes (slickensides) can sometimes be observed in specific layers indicating problems within that layer.

Other behavior and its implications such as material degradation or segregation, intrusion of subgrade fines into the subbase and/or base, erosion of the surface of the base layer due to pumping, and drainage deficiencies should also be noted and described. Degradation of the material as a result of frost action can be observed in areas where ground freezing occurs beneath the pavement. If the test pit is deeper than the normal frost depth, visual observations of the material above and below the frost line will reveal to what depth degradation has progressed. Other distress phenomena that should be sought and noted in the cut face of the surface layer include tensile crack formation at the bottom of asphalt concrete layers, D-cracking in portland cement concrete layers, and shrinkage cracking or heaving of swelling subgrade soils.



An indication of drainage deficiencies in any layer can often be obtained by observing the flow rate from the layer into the pit. In “boxed” construction, where the base and subgrade are not free to drain laterally, drainage deficiencies often go undetected prior to the development of surface distress. The apparent effectiveness of in-pavement drainage features on those sites equipped with them should be assessed for functionality and clogging. If necessary, functional evaluation tests (water injection) should be carried out.

Good quality digital photographs of the test pit profile shall be taken immediately after excavation. The photographs shall be taken at and keyed to the locations described on the test pit log (example Form 11 in Appendix D). The photographs shall be taken to provide a total view of the test pit and close-up views of the pavement profiles. All photos should be taken with the sun behind the photographer whenever possible to avoid shadows. Close up pictures should be taken of distress and associated consequences (e.g., mottling around cracks indicating water saturation) within the pavement structure and cross referenced to the assessment form. The photographs should be stored on a CD, marked and stored in the Project File.



Total view of test pit



Close up view of distress (rut in underlying AC)

**Table 8.2: Checklist for test pit logging (wearing course)**

Parameter	Evaluation					
	Severity	Extent	Start	End	Layer	Description and implications
Cracking						
• Transverse	✓	✓	✓	✓	✓	✓
• Longitudinal	✓	✓	✓	✓	✓	✓
• Fatigue	✓	✓	✓	✓	✓	✓
• Block	✓	✓	✓	✓	✓	✓
• Edge	✓	✓	✓	✓	✓	✓
• Reflective	✓	✓	✓	✓	✓	✓
• Corner	✓	✓	✓	✓	✓	✓
• Durability	✓	✓	✓	✓	✓	✓
• Map	-	✓	✓	✓	✓	✓
Rutting	-	✓	✓	✓	✓	✓
Shoving	-	✓	✓	✓	✓	✓
Raveling	-	✓	-	-	-	✓
Scaling	-	✓	-	-	-	✓
Spalling	✓	✓	-	-	-	✓
Faulting	-	✓	-	-	-	✓
Joint seal damage	✓	✓	-	-	-	✓
Bleeding	-	✓	✓	✓	✓	✓
Pumping	-	✓	✓	✓	✓	✓
Polished aggregate	-	✓	-	-	-	✓
Aggregate condition	-	-	-	-	-	✓
Moisture condition	-	-	-	-	-	✓
Alkali-silica reaction	-	✓	✓	✓	-	✓
Corrosion	-	✓	-	-	-	✓
Pothole repair	-	✓	✓	✓	✓	✓
Crack repair	-	✓	✓	✓	✓	✓

**Table 8.3: Severity and extent descriptors for wearing course layer assessment**

<b>Parameter</b>	<b>Rating</b>	<b>Rating description</b>	<b>Extent description</b>
Transverse cracks	1 - Low 2 - Moderate 3 - High	Distress Identification Manual	Number, length (mm)
Longitudinal cracks	1 - Low 2 - Moderate 3 - High	Distress Identification Manual	Number, length (mm)
Fatigue cracks	1 - Low 2 - Moderate 3 - High	Distress Identification Manual	% area, depth (mm)
Block cracks	1 - Low 2 - Moderate 3 - High	Distress Identification Manual	% area, depth (mm)
Edge cracks	1 - Low 2 - Moderate 3 - High	Distress Identification Manual	Number, length (mm)
Reflective cracks	1 - Low 2 - Moderate 3 - High	Distress Identification Manual	Number, length (mm)
Corner breaks	1 - Low 2 - Moderate 3 - High	Distress Identification Manual	Number, depth (mm)
Durability cracks	1 - Low 2 - Moderate 3 - High	Distress Identification Manual	% area, depth (mm)
Map cracks	Severity not rated	-	% area, depth (mm)
Rutting	Severity not rated	-	Width, depth (mm)
Shoving	Severity not rated	-	% area, depth (mm)
Raveling	Severity not rated	-	% area, depth (mm)
Scaling	Severity not rated	-	% area, depth (mm)
Spalling	1 - Low 2 - Moderate 3 - High	Distress Identification manual	Number, depth (mm)
Faulting	Severity not rated	-	Depth (mm)
Joint seal damage	1 - Low 2 - Moderate 3 - High	Distress identification Manual	Depth (mm)
Bleeding	Severity not rated	-	% area
Pumping	Severity not rated	-	Number, depth (mm)
Polished aggregate	Severity not rated	-	% area
Aggregate condition	Severity not rated	-	Description only
Moisture condition	Severity not rated	-	Description only
Alkali silica reaction	Severity not rated	-	% area
Corrosion	Severity not rated	-	Length (mm)
Pothole repair	Severity not rated	-	Description only
Crack repair	Severity not rated	-	Description only

**Table 8.4: Checklist for test pit logging (bound layers)**

Parameter	Evaluation					
	Severity	Extent	Start	End	Layer	Description and Implications
Cracking						
• Horizontal	✓	✓	✓	✓	✓	✓
• Vertical	✓	✓	✓	✓	✓	✓
• Other	✓	✓	✓	✓	✓	✓
Rutting	-	✓	✓	✓	✓	✓
Pumping	-	✓	✓	✓	✓	✓
Erosion	-	✓	✓	✓	✓	✓
Fines intrusion	-	✓	✓	✓	✓	✓
Degradation	-	✓	✓	✓	✓	✓
Aggregate condition	-	-	-	-	-	✓
Moisture condition	-	-	-	-	-	✓
Mottling	-	✓	✓	✓	✓	✓
Frost action	-	✓	✓	✓	✓	✓
Layer definition	-	-	-	-	-	✓
Interlayer bond	-	-	-	-	-	✓
Moisture at interface	-	-	-	-	-	✓
Pothole repair	-	✓	✓	✓	✓	✓
Crack repair	-	✓	✓	✓	✓	✓
Bleeding <sup>1</sup>	-	✓	✓	✓	✓	✓
Carbonation <sup>2</sup>	-	✓	✓	✓	✓	✓
<sup>1</sup> Asphalt treated base only			<sup>2</sup> Cement treated base only			

**Table 8.5: Severity and extent descriptors for bound layer assessment**

Parameter	Rating	Rating description	Extent description
Horizontal cracks	1 - Low	≤ 6 mm	Number, length (mm)
	2 - Moderate	6 - 19 mm	
	3 - High	> 19 mm	
Vertical cracks	1 - Low	≤ 6 mm	Number, length (mm)
	2 - Moderate	6 - 19 mm	
	3 - High	> 19 mm	
Other cracks	1 - Low	≤ 6 mm	Number, length (mm)
	2 - Moderate	6 - 19 mm	
	3 - High	> 19 mm	
Rutting	Severity not rated	-	Width, depth (mm)
Pumping	Severity not rated	-	Number, depth (mm)
Erosion	Severity not rated	-	% area
Fines intrusion	Severity not rated	-	% area, depth (mm)
Degradation	Severity not rated	-	% area
Aggregate condition	Severity not rated	-	Description only
Moisture condition	Severity not rated	-	Description only
Mottling	Severity not rated	-	% area
Frost action	Severity not rated	-	Depth (mm)
Layer definition	Severity not rated	-	Description only
Interlayer bond	Severity not rated	-	Description only
Moisture at interface	Severity not rated	-	Description only
Pothole repair	Severity not rated	-	Description only
Crack repair	Severity not rated	-	Description only
Bleeding	Severity not rated	-	% area
Carbonation	Severity not rated	-	% area, depth (mm)

**Table 8.6: Checklist for test pit logging (unbound layers)**

Parameter	Evaluation					
	Severity	Extent	Start	End	Layer	Description and Interpretation
Cracking						
• Horizontal	✓	✓	✓	✓	✓	✓
• Vertical	✓	✓	✓	✓	✓	✓
• Other	✓	✓	✓	✓	✓	✓
Rutting	-	✓	✓	✓	✓	✓
Pumping	-	✓	✓	✓	✓	✓
Erosion	-	✓	✓	✓	✓	✓
Fines intrusion	-	✓	✓	✓	✓	✓
Degradation	-	✓	✓	✓	✓	✓
Moisture condition	-	-	-	-	-	✓
Mottling	-	✓	✓	✓	✓	✓
Frost action	-	✓	✓	✓	✓	✓
Layer definition	-	-	-	-	-	✓
Interlayer bond	-	-	-	-	-	✓
Moisture at interface	-	-	-	-	-	✓
Pothole repair	-	✓	✓	✓	✓	✓
Crack repair	-	✓	✓	✓	✓	✓
Aggregate description	Described as per ASTM D 2488 - Description and identification of soils (visual-manual procedure)					
• Angularity						
• Shape						
• Color						
• Odor						
• HCl Reaction						
• Consistency						
• Cementation						
• Structure						
• Size range						
• Max particle size						
• Hardness						
• Condition						

**Table 8.7: Severity and extent descriptors for unbound layer assessment**

Parameter	Rating	Rating description	Extent description
Horizontal cracks	1 - Low	≤ 6 mm	Number, length (mm)
Vertical cracks	2 - Moderate	6 - 19 mm	
Other cracks	3 - High	> 19 mm	
Rutting	Severity not rated	-	Width, depth (mm)
Pumping	Severity not rated	-	Number, depth (mm)
Erosion	Severity not rated	-	% area
Fines intrusion	Severity not rated	-	% area, depth (mm)
Degradation	Severity not rated	-	% area
Moisture condition	Severity not rated	-	Description only
Mottling	Severity not rated	-	% area
Frost action	Severity not rated	-	Depth (mm)
Layer definition	Severity not rated	-	Description only
Interlayer bond	Severity not rated	-	Description only
Moisture at interface	Severity not rated	-	Description only
Pothole repair	Severity not rated	-	Description only
Crack repair	Severity not rated	-	Description only
Aggregate description	Severity not rated	-	Description only

## **8.11. In-Pit Testing**

In pit-testing will typically include density, moisture content and dynamic cone penetrometer. Additional tests may be required to assess specific parameters (e.g., temperature gradient measurements on day of sampling). Care should be taken in interpreting measurements taken on the day of sampling, especially those that are weather related, given the wide variation that will be experienced between sites. When nuclear testing is carried out in a hole, it is useful to run a calibration check to assess the influence of reflection. If large discrepancies are obtained compared with the standard counts, the results should be used with caution. Care should be used when interpreting nuclear density results from asphalt treated or recycled asphalt pavement (RAP) base materials

### **8.11.1 Reference Standards**

The following reference standards are applicable to this Section:

- AASHTO T 310 - “In-place density and moisture content of soil and aggregate by nuclear methods (shallow depth)”
- ASTM D 2950 - “Standard test method for density of bituminous concrete in place by nuclear methods”
- ASTM D 5195 - “Test method for density of soil and rock in-place at depths below the surface by nuclear methods”
- ASTM D 6951 - “Standard test method for use of the DCP in shallow pavement applications”

### **8.11.2 In Situ Density and Moisture Measurements**

Pavement design procedures assume that the layers in the pavement structure have been compacted to specific minimum relative density, the key structural parameters implied by meeting the specified density are reliable for design purposes, and that compaction will vary little during the life of the pavement. Therefore the testing of the density is fundamental for assessing the validity of the designs. Key structural parameters such as strength, stability and modulus may change over time as a result of changes in moisture content, intrusion of fines, degradation and frost action and thus the assumption that a satisfactory relationship exists between relative density and the key structural parameters may not always be valid. In certain instances the specified density may not have been achieved during construction or may have been affected by mechanical action of traffic, frost or salt. By determining site-specific conditions during the forensic investigation, the relationships between the subsurface conditions and long-term performance will be better understood.

Equally important is the accurate determination of the in situ moisture content of each pavement layer, including the subgrade. Laboratory testing programs include a spectrum of tests, many of which are performed on representative samples compacted to the specified density at moisture contents simulating in situ conditions. Assessing the validity of these tests and the use of the results with parameters such as



deflection in pavement design, will be possible only if accurate field density and moisture contents can be determined.

Three in situ density and moisture measurements should be made on the surface of all untreated base, subbase, and subgrade layers during excavation of the test pit. One measurement should be taken in each wheel path and one at the center point between the wheel paths. One measurement (i.e., test) shall be the result of the average of four readings made during each 90° rotation of the nuclear gage through a full 360°. Measurements should be recorded on an appropriate form (Form 12 in Appendix D).

#### Special Procedural Provisions

Two nuclear gages should be available at the test site. One gage will serve as a stand-by in the event the regular test gage becomes inoperative, or is of questionable accuracy. Nuclear equipment and testing will be conducted in full compliance with all federal, state, and local regulations. Nuclear gage operators shall be licensed or qualified in accordance with requirements. Dosimeter badges should be provided to all field crew members involved in use of the nuclear gages or working in close proximity. The badges should be periodically checked as required by Federal, state and local regulations.

Standardization of the nuclear density testing equipment on a reference standard is required at the start of each day's use and when the test measurements are suspect. Calibration of the nuclear gages should be performed annually and at other times if the accuracy of test results seems questionable.

One density and one moisture measurement shall be made on each untreated base, subbase and subgrade soil layer, using the direct transmission method for density and backscatter method for moisture. For the density test the rod shall be imbedded 100 to 200 mm (4 to 8 in) below the layer surface as appropriate to test the full layer. Each measurement shall be the average of four readings of one minute each taken at the same general location (hole) but with the instrument rotated 90° between each reading.



Prior to testing, the surface shall be leveled and smoothed and water, if present, in the test area shall be removed.

A bag and moisture jar sample shall be obtained beneath each test for laboratory moisture testing. Location for the test and obtainment of samples shall be as shown in Figure 8.3. Minimum sample sizes shall be 5 kg ( $\pm$ 11 pounds). The sample shall be dried to constant mass. Extreme care shall be taken to obtain samples at the true natural field moisture condition. The density, moisture, type of material, rod end depth and thickness of the each tested layer shall be reported on the form. Any unusual findings



during the testing and bulk sampling such as voids, oversized aggregate or cobbles, foreign material, trapped water, etc. which may have affected the measurements should also be reported. Tests are not required on subgrade material containing an amount of rock sufficient to preclude accurate testing.

### 8.11.3 Dynamic Cone Penetrometer (DCP) Testing

The DCP test provides a simple and inexpensive means of determining layer strengths at a particular point on the road at a particular time. Although comprehensive deflection (FWD) measurements might have been recorded on each section throughout the study, FWD equipment is not always available for routine testing of other pavements. Taking DCP measurements on the experiment will enable comparison with the FWD measurements already taken.



If DCP measurements are considered necessary, they should be taken prior to excavation of the test pits in each of the wheel paths and in-between the wheel paths. Measurements should be recorded at 5-blow intervals to a depth of 800 mm ( $\pm 320$  in). If layers are particularly weak, measurements should be taken after every blow. Bound layers should be drilled. Results should be recorded on the DCP Form (example Form 13 in Appendix D).

### 8.11.4 Other Testing

Depending on the type of experiment and the type and nature of the distress recorded, additional on site testing may be required. The details of any other testing carried out should be noted on the assessment form. The data collected should be recorded on an appropriate form and attached to the site report (example Form 5 in Appendix D).

## 8.12. Test Pit Repair

Following completion of the test pit activities, the pit should be repaired.

### 8.12.1 Asphalt Concrete Pavements

Excess untreated material should be replaced in the pit and compacted in layers corresponding to the original pavement structure at the correct moisture content and similar density to the adjacent materials. Base and surfacing should be reinstated in the form of a patch using asphalt concrete according to state specifications. Quality control should be carried out according to state requirements. The patch should be monitored after repair to ensure that settling has not occurred and that there is no cracking or possibility of water ingress at the joints.



Core holes should be patched with an appropriate mix according to state requirements.

### 8.12.2 Portland Cement Concrete Pavements

The following procedure should be followed when opening the test pit in order that the slab can be repaired or replaced on completion of the investigation:

- Saw completely through concrete surface along all edges of the test pit and place anchor plugs in the pavement slab to be removed
- Place anchor bolts in the plugs and string steel cable through the eyelets
- With backhoe or front end loader attached to the cable, lift the test pit slab in one piece and place beside the test pit area
- Complete all sampling and testing activities as described in the previous chapters
- Replace sampled areas with suitable base and subbase material and compact with pneumatic tampers to maximum attainable density to a level even with the bottom of the concrete surface. The density should be measured and recorded as described previously.
- Replace the concrete slab, remove anchor bolts, and seal joints as per the appropriate state specifications



For continuously reinforced concrete or other instances when the above procedure is not feasible, an overnight lane closure followed by permanent patching the following day or the placement of a temporary patch at the completion of the sampling and testing followed by permanent restoration at a later time may be employed.

If temporary patching is elected, the following procedure can be considered:

- After completion of the testing, place aggregate base material equivalent to that removed
- Compact each layer with pneumatic tampers to maximum attainable density. The density should be measured and recorded as described previously.
- Place asphalt concrete temporary patch mixture (hot mix or cold mix of high stability) in two layers and compact each layer with pneumatic tampers to maximum attainable density.
- This temporary patch should be replaced by a more permanent restoration of the pavement surface at a more suitable time.

### 8.12.3 Site Cleanup

The responsible official should remove all signs, equipment, material and debris from the work site. This shall include, but not be limited to, loose soil, particles of aggregate, concrete, asphalt, and mud coatings

on the roadway and shoulder. Material removed from the test pit that is not required to be shipped or used to restore the test pit shall be disposed of off the State Right-of-Way and in accordance with state highway and local requirements.

### **8.13. Project Site Report**

The project site report should only be signed off when the Project Engineer is satisfied that all materials have been shipped, that the pit and core holes have been correctly reinstated, markings repainted and that the site has been satisfactorily cleaned up.

### **8.14. Checklists**

All relevant issues will be listed on the forensic investigation checklist, which must be signed off by the Project Engineer(s) on completion of construction. Examples of the checklists relevant to this chapter are provided in Appendix B.

### **8.15. Quality Management**



Quality management issues pertaining to the roles and responsibilities described in this chapter include:

- Understanding the requirements for a forensic investigation in the Experiment Work Plan or motivating the need for one if the matter was not considered earlier
- Undertaking the forensic investigation according to standard practices
- Sampling all relevant materials at the time and to the requirements specified in the Experiment Work Plan
- Completing all relevant checklists, forms and labels

#### **8.15.1 Data Management**

Considerable data will be collected during a forensic investigation. Data should be recorded on appropriate forms designed to meet the needs of the experiment. Examples of forms are provided in Appendix D. Mandatory information should include:

- Name of evaluator
- Date
- Route number
- County/district
- Section name and number
- Signature of evaluator
- Signature of person performing quality management

All documents should be added to the Project File. In order to facilitate later data analysis, all data from the forms should be captured into a spreadsheet as soon as possible after the forensic investigation (i.e., one week). Timely capture will allow checks to be made and any missing data to be collected while the investigation is still clear in the Engineers mind. A copy of the spreadsheet, named according to the experiment naming principle described earlier, plus date, should be forwarded to the Database Manager.

### **8.15.2 Responsibility**

The Project Engineer is responsible for:

- Undertaking or delegating the forensic investigation as detailed in the Experiment Work Plan
- Ensuring that the forms and other relevant documentation are sent to the Database Manager
- Ensuring that any samples collected reach the laboratory and are tested as per the Experiment Work Plan
- Maintaining the Project File

The Database Manager is responsible for:

- Capturing the data in the database

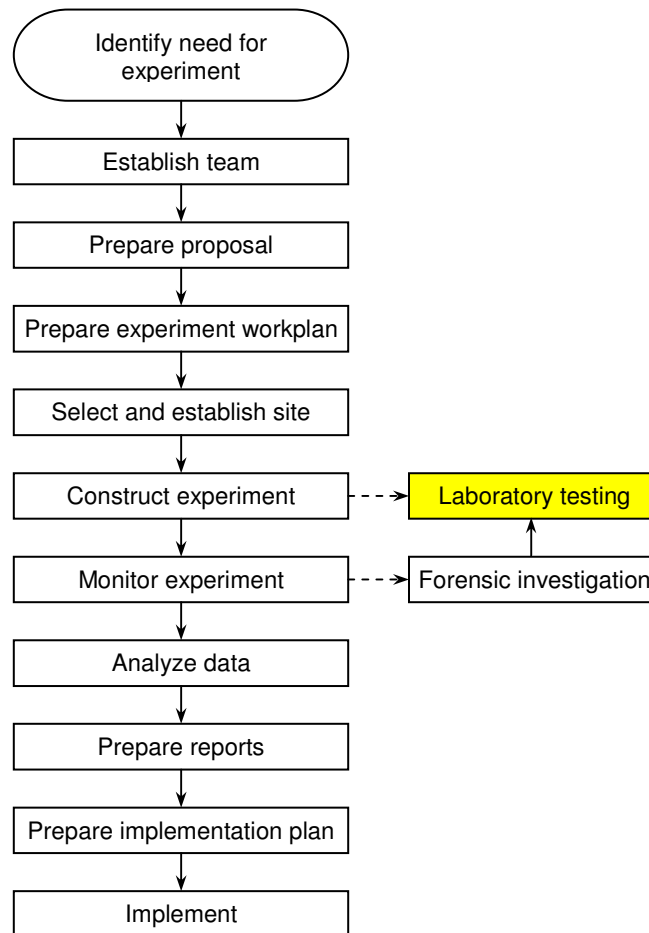
The Project Champion is responsible for:

- Deciding whether a forensic investigation is justified
- Approving all checklists



## 9. LABORATORY TESTING

---



### 9.1. Introduction



Laboratory testing is carried out in order to obtain an understanding of the material characteristics of the existing road surface or treatment being applied. In most instances these properties need to be known in order to understand why the road performed the way it did and to determine a set of criteria that can be used as a basis for determining where treatments or techniques that are being assessed can be applied elsewhere on the network.

Laboratory testing should only be carried out when the results will enhance knowledge of how the pavement performed and the reliability of the findings of the study in terms of addressing the study

objectives. Testing should not be carried out simply for the sake of testing. The need for testing and the type of testing will be identified in the Experimental Work Plan.

Testing that might be carried out typically includes characterization of the properties, durability, and performance of the various materials used in the experiment, and samples removed during the course of the experiment or after completion of the experiment. This includes, but is not limited to the following. In all instances, control specimens should also be tested for comparative purposes.

- Binders and rejuvenating sprays
- Aggregate
- Fillers
- Crack and joint sealants
- Reinforcing grids
- Cores and slabs

## 9.2. Tests

A discussion on laboratory testing falls outside the scope of this guideline. However, the following should be considered before testing:

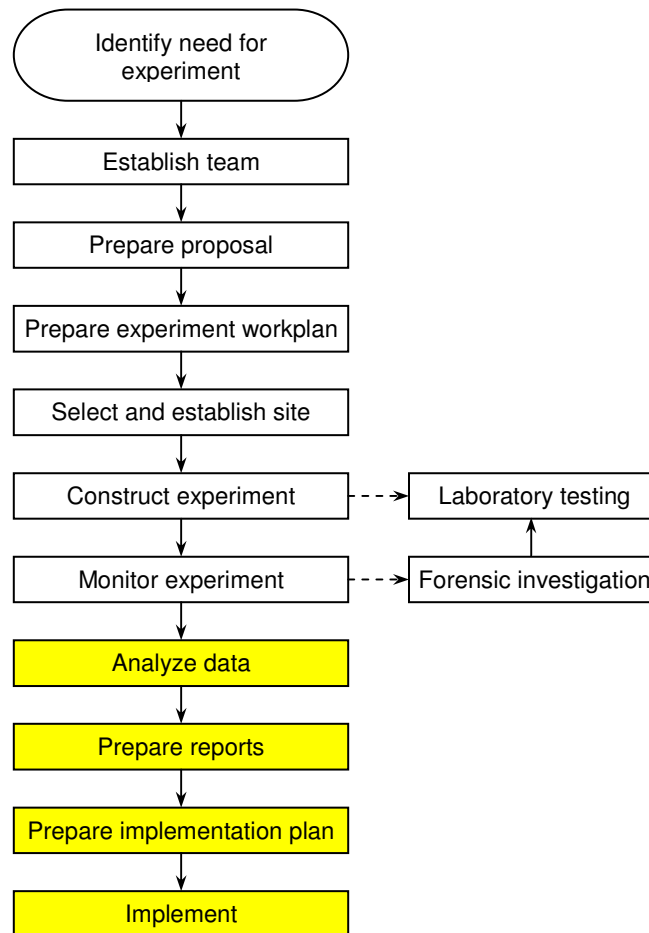
- Care should be taken to fully understand a test, its purpose and its limitations before selecting it. Most tests are developed for a specific purpose. When used to test something outside the original scope, the mechanism and results may not be entirely relevant. Results need to be interpreted with care and the test may need to be modified to suit the need.
- An appropriate method may need to be sought to test a particular parameter. This may not be commonly used within Caltrans and laboratory staff may need to be trained in its use. Alternatively, a new test may need to be adopted or developed to address a particular need.
- Test methods should be strictly adhered to, unless modified to suit the needs of the experiment. If modified, the changes need to be clearly documented with a justification for doing so. Test methods should not be changed simply to obtain a satisfactory answer.



Laboratory testing procedures are fully documented in the California Test Methods document. Where appropriate, ASTM, AASHTO and/or other organizations' test methods may be followed. The reasons for using an alternative test method should be justified.

## 10. DATA ANALYSIS, REPORTS, AND IMPLEMENTATION

---



### 10.1. Introduction



Appropriate data analysis and reporting is a fundamental part of any experiment. In this phase of the research, the data collected from the visual assessments and measurements is analyzed to determine whether the strategy, treatment, technology, procedure and/or product performed and behaved in a manner, such that adoption of it would have benefits over existing practice. These benefits could include, but are not limited to:

- Improved performance
- Longer periods between pavement preservation treatments
- Reduced user delays
- More cost-effective
- Simplified and/or easier construction



In this chapter, data analysis and construction, progress, and first and second level analysis reports are discussed.

## 10.2. Data Analysis

The focus of data analysis will be the systematic comparison of the behavior and performance of the strategy, treatment, technology, procedure or product against that of the control. The criteria that are used for this comparison will depend on the Experiment Work Plan. Examples include, but are not limited to:

- Cost
- Time taken to “fail” (e.g., riding quality, rutting, cracking, etc.)
- Mode of failure
- Maintenance requirements
- Environmental and/or safety benefits
- User delays associated with construction

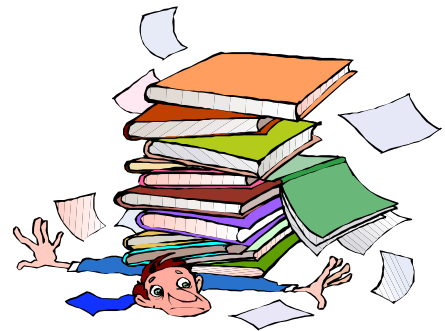


## 10.3. Reports

Reports are the means by which experiments, findings and recommendations are documented. Format and content will depend on the type of experiment. Details on report writing are beyond the scope of this document.

Five types of report are typically prepared during the course of an experiment:

- Site selection report
- Construction report
- Progress/interim reports
- Research reports
  - First-level analysis report
  - Second-level analysis report
- Implementation report



### 10.3.1 Site Selection Reports

Site selection reports are discussed in Chapter 5.

### 10.3.2 Construction Reports

Construction reports are discussed in Chapter 6.

### **10.3.3 Progress Reports**

Progress reports provide a means for maintaining momentum with the experiment and for informing individuals not directly involved in the study about progress. They should be brief to ensure that they are read. Progress reports should follow a standard format to ensure that only relevant information is included. Content should include:

- Evaluations completed since previous report
- Performance compared to that detailed in the previous report
- Implications of the findings to date
- Recommendations to continue or terminate the experiment

Progress reports are typically prepared once or twice a year and should coincide with monitoring evaluations.

Progress reports are prepared by the Project Engineer and approved by the Project Champion.

### **10.3.4 Experiment (Research) Reports**

#### First-level Analysis Report

A first-level analysis report should be compiled when all testing has been completed (i.e., experiment termination point has been reached) and all data has been captured. It should provide a background to the study, the study objectives, experimental design, monitoring, measurements taken, results of analysis, interpretation and recommendations for and benefits/implications of adoption. The report should be prepared by the Project Engineer in Caltrans Research Report format, reviewed by a technical specialist in the field of study (typically identified during preparation of the Test Work Plan) and approved by the Project Champion before being submitted to the relevant Caltrans divisions and districts. The content of the report will be detailed in the Test Work Plan, but will typically include the following chapters:

- Introduction
- Project team
- Test work plan and revisions
- Site selection and location
- Construction
- Evaluation
- Benefits and implications of adopting the technology
- Conclusions and recommendations
- References
- Appendices

### Second-Level Analysis Report

A second level analysis report should be prepared if the experiment was part of a larger study. This report should summarize the entire study, detail the benefits and implications of adopting the technology and provide recommendations for implementation. The actual content of the report will depend on the objectives of the experiment. The report should be prepared by the Project Engineer(s). The standard Caltrans Report format and approval procedures should be followed. The report should be reviewed by a technical specialist in the field of study and approved by the Project Champion before submission to the relevant Caltrans divisions and districts.

#### **10.3.5 Implementation Reports**

The implementation report provides a summary of the experiment and the findings, together with recommendations on how the findings should be implemented. These recommendations should include a procedure and sign-off sheet for implementing/adopting the findings (e.g., through workshops with relevant staff in the districts, identifying candidate projects, modifying procedures and specifications, etc). The summary report should be presented to the relevant office chiefs and disseminated to the district maintenance and materials engineers, and depending on the outcome, an implementation/adoption timetable should be agreed to.

### **10.4. Implementation**

Implementation of the findings is perhaps the most important, but often most overlooked, phase of any experiment. By following the procedures discussed in this guideline, valid and quantified justifications for implementing new or improved technologies and procedures can be developed. Once defined, these technologies and procedures need to be systematically implemented. The following implementation process is proposed:

- The project champion should notify relevant head office staff and district office maintenance and materials engineers about the experiment(s) in the early stages of the study. This notification can also be seen as an opportunity to identify potential replicate sections, and to find out about similar experiments that may have been conducted in the past, but not documented.
- The project engineer should send brief progress reports and updates via email to head office staff and district office maintenance and materials engineers throughout the duration of the study. If early significant findings are noted, engineers from other districts should be encouraged to visit the experiment as part of future monitoring exercises.
- On completion of the study, the summary/implementation report should be presented to the office chiefs at a Pavement Standards Team meeting. This exercise should be used to initiate the implementation plan proposed in the implementation report.
- Depending on the recommendations in the implementation report, proceed with implementation. This may include:

- Revision of the Maintenance Technical Advisory Guide (MTAG)
- Revision of standards, guideline documents, specifications and procedures
- Notifying relevant staff of the revised procedures
- Holding workshops and demonstration projects to disseminate the findings.

Responsibility for implementation rests with the Chief of the Office of Pavement Preservation and the Project Champion.



## 11. DATA MANAGEMENT AND DOCUMENTATION

---

### 11.1. Introduction

A comprehensive record of data documenting the behavior of the test section and comparison to a control is critical to the success of any experiment. This requires a systematic data capture, storage, and retrieval procedure to ensure accuracy, uniformity and continuity in measurements.



The Project File, checklists, data collection forms, proposal register, experiment register and progress reports are discussed in this chapter.

### 11.2. Project File

A project file should be opened for each experiment when a proposal is prepared. The project file will need to accommodate both electronic and paper based data. All documentation associated with the experiment should then be filed in the Project File for future reference. Initially, the project file will be the responsibility of the person preparing the proposal, but once the proposal is approved/rejected, it will become the responsibility of the Database Manager. It should be remembered that the Project File “belongs” to an experiment and not to an individual and the contents should be accessible to any interested person.

Contents of the project file should include, but not be limited to:

- Proposal
- Records of decision
- Experiment Work Plan (all versions)
- Experiment location, details and map
- Construction report
- Monitoring forms and photographs
- Progress reports
- Analysis documentation
- First and second level analysis reports
- Recommendations for implementation
- Experiment termination report
- Location of additional data



form. Where appropriate, information should also be captured on a data board positioned in the photograph.



**Examples of data boards**

All data from the forms should be captured into a spreadsheet or database as soon as possible after they have been collected. In certain instances, data may be captured directly into a spreadsheet on-site during monitoring. However, in most instances, the nature of the monitoring exercise renders it unsuitable for direct data capture. Timely capture will allow checks to be made and any missing data to be collected while the construction process or assessment is still fresh in the Engineer's mind (typically no more than five days). A spreadsheet should be created for each section within the experiment. Separate worksheets should be created within the spreadsheet for each assessment and named according to date of the assessment. The format of each worksheet should be exactly the same throughout to facilitate statistical analyses. The spreadsheet should be named according the experiment and section number together with date.

By capturing data on separate sheets with the same format, first-level data checks can be carried out using comparative graphs.

## **11.5. Numbering Systems**

Centralized numbering systems provide a simplified means of tracking experiments statewide, and the documentation prepared from them. The following numbering systems are used.

### **11.5.1 Experiment Proposal Register**

A proposal register is maintained by the Chief of the Office of Pavement Preservation. This facilitates the tracking of proposals for experiments statewide and ensures that experiments are optimized and not



unnecessarily duplicated. When Caltrans staff (head office or district) are considering experiments, they should check the register to establish whether similar proposals have been submitted in the past.

The following register format is used:

Owner <sup>1</sup>	Pavement Preservation						
Document type	Descriptor	District	Year	Number <sup>2</sup>	Version <sup>3</sup>	Date <sup>4</sup>	Implementation <sup>5</sup>
Experiment proposal	PPTS	3	05	1	1	05/01/05	
<sup>1</sup>	Responsible Caltrans Division/Office						
<sup>2</sup>	Sequential number starting at 01 on January 01 each year						
<sup>3</sup>	Sequential number for each modification to the Experiment Proposal						
<sup>4</sup>	Date that the revision is approved						
<sup>5</sup>	Details on whether the proposal was implemented, experiment work plan number, experiment number, start date, end date, report numbers etc.						

An example of a numbered experimental proposal is shown below.

## EP-PPTS/3/05/1/ver1

Where: EP - Experiment proposal  
PPTS - Pavement preservation test section  
3 - The district(s) where the experiment(s) are located  
05 - Year that proposal is submitted  
1/ver1 - Sequential numbers for proposal and revision

### 11.5.2 Experiment Register

The Caltrans Pavement Preservation Test Section register is maintained by the Chief of the Office of Pavement Preservation. Like the proposal register, this register helps to optimize experimental designs. Unnecessary duplication is avoided, studies can be tracked to completion and new experiments can be structured and planned as extensions of existing or completed experiments. It provides a source of reference to previous experiments, which allows Project Managers to prepare new test work plans in line with previous work plans such that data analysis and comparisons of performance will be simplified.

The experiment register format is summarized below:

Owner <sup>1</sup>	Pavement Preservation							
Experiment type <sup>2</sup>	Descriptor	District	Year	Number <sup>3</sup>	Section <sup>4</sup>	Description <sup>5</sup>	Date <sup>6</sup>	Links <sup>7</sup>
Crack sealant comparison	PPTS	3	05	1	1		05/01/05	
<sup>1</sup>	Responsible Caltrans Division/Office							
<sup>2</sup>	Brief description of the type of experiment							
<sup>3</sup>	Sequential number starting at 01 on January 01 each year							
<sup>4</sup>	Sequential number for each section within the experiment, including the control							
<sup>5</sup>	Description of the section							
<sup>6</sup>	Date that number was issued							
<sup>7</sup>	Links (i.e., document number) to experiment proposal and experiment work plan numbers							

An example of an experiment number is shown below:

## PPTS/3/05/1/1

where: PPTS - Pavement preservation test section  
 3 - District 3  
 05 - Year that proposal is submitted  
 1/1 - Sequential numbers for experiment and sections within the experiment

### 11.5.3 Report Number Register

Reports prepared during and on completion of pavement preservation experiments should be allocated a unique report number to facilitate later document retrieval. A Caltrans Pavement Preservation Test Section Report register is maintained by the Chief of the Office of Pavement Preservation and numbers should be sourced from this office. The numbering system provides a central register of all reports prepared from the monitoring of pavement preservation test sections and facilitates the retrieval of documents by other districts who may wish to implement the findings or conduct additional experiments. It is also a ready source of information for individuals undertaking a literature review prior to the initiation of experiments. The Chief of the Office of Pavement Preservation uses the Report Numbering Register to track the progress of experiments and to ensure that documentation is finalized and where appropriate, findings are implemented as standard Caltrans practice.

Pavement Preservation Test Section Report Numbers are explained below:

Owner <sup>1</sup>	Pavement Preservation					
Document type	Descriptor	Year	Number <sup>2</sup>	Version <sup>3</sup>	Date <sup>4</sup>	Implementation <sup>5</sup>
Experiment work plan	PPTS	05	1	1	05/01/05	
Construction Report	PPTS	05	1	1	06/01/05	
Interim report	PPTS	05	1	1	07/01/05	
Experiment Report	PPTS	05	1	1	12/01/05	
<sup>1</sup> Responsible Caltrans Division/Office <sup>2</sup> Sequential number starting at 01 on January 01 each year <sup>3</sup> Sequential number for each modification to the Experiment Proposal <sup>4</sup> Date that the revision is approved <sup>5</sup> Details on whether the proposal was implemented, experiment work plan number, experiment number, start date, end date, report numbers etc.						

Examples of the numbering system are:

## ES-PPTS/05/1/ver1

where: ES - Experiment work plan  
 PPTS - Pavement preservation test section  
 05 - Year that work plan is first written  
 1/ver1 - Sequential numbers for work plan and revision

## **CR-PPTS/05/1/ver1**

where: CR - Construction report

## **IR-PPTS/05/1/ver1**

where: IR - Interim report

## **ER-PPTS/05/1/ver1**

where ER - Experiment report

### **11.6. Data Validation and Storage**

The data collected from each evaluation should undergo a first-level data check by both the Project Engineer and the Database Manager. This will include, but not be limited to:

- A check that data does not fall outside predetermined minimum and maximum boundaries (e.g., a severity cannot exceed 5, percentage areas cannot exceed 100)
- A comparison with data collected from the previous monitoring exercise to check inconsistencies (e.g., rut depth less than previous)

Data can be transferred from the forms to a spreadsheet to facilitate later analysis. However, the original forms must be retained in the project file for later reference. Photographs should be stored electronically in a series of subdirectories linked to the monitoring dates. Care must be taken to ensure that the numbers on the photographs match those on the evaluation forms and that there will be no confusion when analyzing the data. Electronically collected data should be stored in a similar manner. The date, and if appropriate the time, that the photograph was take should be included in the file name.

The quantity of data typically collected from a pavement preservation test section, combined with the rapid developments in the Information Technology arena, necessitate conscientious and regular attention to the entire database to ensure that it is always accessible using current hardware and software. Considerable useful information on various road projects collected in the past has been lost or become unusable due to poor or erratic database management. The database must be comprehensively backed up regularly and these backups must always be upgraded when new hardware and software is installed.

The database should be compatible with other relevant databases in order that results can be directly compared or analyzed together.

In order to facilitate the use of the information in the databases by authorized individuals, Internet access should be considered as part of the database development.

## 11.7. Project Closure

All projects need to be closed. For a pavement preservation experiment, project closure will usually occur once the final report has been submitted and an implementation plan has been initiated by the Chief of the Office of Pavement Preservation.

Project closure typically involves, but is not necessarily limited to, the following:

- Submission of all reports
- Initiation of an adoption/implementation plan
- Finalization of the database
- Finalization and closure of the project file
- Archiving the project file
- Disposal of all material samples
- Removal of signs, markings and instrumentation from the site
- Updating of all registers by the Chief of the Office of Pavement Preservation
- Notification of project closure to all team members and other interested and affected parties

An example checklist for project closure is provided in Appendix B (Checklist 14).

Project closure is the responsibility of the Project Manager.



## 12. BIBLIOGRAPHY

---

1. **California Department of Transportation Website** - <http://www.dot.ca.gov>.
2. **Caltrans Safety Manual**. 2000. Sacramento, CA: State of California Department of Transportation. - <http://www.dot.ca.gov/hq/opo/safety/safetymanual>
3. **Construction Manual**. 2003. Sacramento, CA: State of California Department of Transportation. (<http://www.dot.ca.gov/hq/construc/manual2001/>)
4. **Distress Identification Manual for the Long term Pavement Performance Program (4<sup>th</sup> Edition)**. 2003. Washington, DC: Federal Highway Administration. (FHWA-RD-03-031). (<http://www.tfhrc.gov/pavement/ltp/reports/03031/03031.pdf>)
5. **Generic Experimental design for Product/strategy Evaluation - Crumb Rubber modified Materials**. 2005. Sacramento, CA: State of California Department of Transportation. (<http://www.dot.ca.gov/hq/esc/Translab/fpmlab/>).
6. **Guide to the Investigation and Remediation of Distress in Flexible Pavements**.
7. **Index of California Test Methods** - <http://www.dot.ca.gov/hq/esc/ctms/>
8. **Maintenance Manual**. 2000. Sacramento, CA: State of California Department of Transportation. (<http://www.dot.ca.gov/hq/maint/manual/>).
9. **Maintenance Technical Advisory Guide (MTAG)**. 2003. Sacramento, CA: State of California Department of Transportation. (<http://www.dot.ca.gov/hq/maint/mtag/>).
10. **New Product Evaluation Guidelines**. 1999. Sacramento, CA: State of California Department of Transportation. ([http://www.dot.ca.gov/hq/esc/approved\\_products\\_list/NPGuidelines.html](http://www.dot.ca.gov/hq/esc/approved_products_list/NPGuidelines.html))
11. **Pavement Condition Survey Manual**. 2002. Sacramento, CA: State of California Department of Transportation.



---

**APPENDIX A**

**PROPOSED CALTRANS INNOVATION PROCESS**

---



## APPENDIX A: PROPOSED CALTRANS INNOVATION PROCESS

---

The Caltrans Division of Maintenance, Office of Pavement Preservation has prepared a draft procedure for undertaking studies on innovation in pavement preservation. The process was developed independently of this document and is provided below. Further information on the process should be obtained from the Chief of the Office of Pavement Preservation.

### A.1 Procedure

The following procedure should be followed when approval is being sought to undertake an investigation into the use of an innovative process of product (see Flow chart at end of Appendix A):

- A. Innovators approach the Pavement Preservation Task Group Chair, PPTG Chair (or the New Products Coordinator, NPC) with a pavement preservation innovation. The innovators will provide information on the innovation electronically using the pre-proposal format (elements 1–7). If the innovation contains a new product the New Products form will be filled out and sent to the NPC. The NPC will then begin the process for creating a MSDS sheet. The pre-proposal will be logged into a database by the Innovation Coordinator for status updates.
- B. PPTG Chair will distribute the innovation information to both the innovation and subject-specific sub-task groups. The sub-task groups will help identify Caltrans' champions. PPTG Chair will also notify the NPC of the innovation. If the innovation contains a new product, PPTG Chair will direct the innovator to submit the appropriate MSDS and safety information to the New Products Process.
- C. The innovators and Caltrans' champions will develop full proposal for the innovation process. The proposal shall include the information requested in the innovation proposal format (elements 1-15) and be submitted electronically to the Innovation Coordinator.
- D. The Innovation Coordinator will distribute the innovation proposal to the innovation sub-task group. The innovation group will determine whether the proposal has the necessary information to go forward. This will be accomplished via email to the membership and require comments within one week. No comments implies acceptance.
- E. The innovation sub-task group forwards the proposal to the subject-specific sub-task group. They would review and provide comments, via email or meetings, within two weeks.
- F. The innovation sub-task group will examine the comments made by the subject-specific sub-task group for objectivity. This will be accomplished via email to the membership and require comments within one week. All comments will be collected by the Innovation Coordinator.
- G. The PPTG Chair will receive comments from the Innovation Coordinator and, if the New Products Process is involved, the necessary safety information. PPTG Chair will then decide to proceed, reject or ask for further information. This further information could be presentations to the PPTG

Chair and appropriate Caltrans' staff (e.g., District engineers, Maintenance management, etc.). If the vendor is to be paid for the innovation the PPTG chair will submit it to the PST for creation of an NSSP.

- H. The finished proposal and comments are entered in to database by the Innovation Coordinator and submitted to the Maintenance Approval Process. The Innovation Coordinator will keep the innovation and subject-specific sub-task groups informed.
- I. Caltrans Approval process (to be determined by CT Maintenance)
- J. The Innovation Coordinator would facilitate and collect the evaluation information before, during and after the construction. Tests would be scheduled at the site prior to and during the construction as described in the proposal. The Innovation Coordinator would facilitate (e.g., remind the necessary parties of up and coming tests) post-construction tests and collect the necessary evaluation information. Note, the database should include elements for all possible tests taken before, during, and after the construction. This includes all items taken in the surface distress survey, deflection testing, etc.
- K. A construction report will be written by the innovators and the Caltrans' champions and turned into the PPTG Chair. Items in the report shall include:
  - Location, dates, times of construction and weather
  - Specification and equipment used
  - Testing done during and immediately after construction (e.g., QC/QA data)
  - Deviation from specification or materials
  - Problems encountered and locations where problem occurred
- L. The Innovation Coordinator would facilitate the writing of the final report (elements 16–20) at the end of the evaluation period.
- M. The Innovation Coordinator would direct successful innovations to the appropriate specification committee.

## **A.2 Innovation Pre-Proposal, Proposal and Final Report Formats**

### **A.2.1 Objective**

The innovation requires a description on how the innovation can be utilized by Caltrans Maintenance in their strategies to maintain the flexible and rigid pavements within their road system. The maintenance procedures are limited by the definition of surface treatments, up to 30 mm (1.2 in.) compacted. One exception is surface recycling which could include the top 100 mm (4 inches) of pavement.

The innovation can be a product, a process, an idea or other avenues, which can be used in a maintenance procedure that results in a benefit or improvement over existing procedures. Note, the format described below is meant to convey the necessary information (see below). As the pre-proposal moves to proposal stage and eventually to a final report stage, elements are simply added on per stage.

This essentially starts the final report at the very beginning. Note that the pre-proposal, proposal, and final report should all be submitted electronically (and eventually could be web-based).

### **A.2.2 Elements of the Innovation Pre-Proposal**

The following elements should be included in the pre-proposal:

1. Title
2. Contact information  
Name and contact information of the submitter.
3. Description  
What is the innovation? Include patent information, if applicable
4. Benefits  
What are the benefits of the innovation? How does this compare to similar innovations? Why is this innovation better?
5. Selection criteria  
What is the appropriate pavement (e.g., age, location, distress, etc.) and application conditions of the innovation (e.g., pavement and air temperatures, day, night, humidity, etc.)? Note that distress conditions must be consistent with Caltrans' Pavement Condition Survey Manual and/or the Maintenance Technical Advisory Guide, MTAG  
(url: [http://www.dot.ca.gov/hq/maint/MTA\\_Guide.htm](http://www.dot.ca.gov/hq/maint/MTA_Guide.htm)).
6. Specifications  
Provide a specification. This includes other countries, states, industry or municipalities. Provide a copy with the report.
7. Background  
Has the innovation been used in California or elsewhere? Does the innovation have any field performance data? Provide details.

### **A.2.3 Elements of the Proposal**

The following elements should be included in the full proposal. Note that items 1–7 of the pre-proposal will be included as the first six items of the full proposal.

8. Potential Locations  
Working with the Caltrans' champion, identify potential sites for utilizing innovation. Provide Co-Route-Post Mile; job information (EA), if attached with a construction project; control sections; and construction season. Also, describe how each test section will be identified. This element should follow the recommendations in the Pavement Preservation Studies Technical Advisory Guide.
9. Estimated Costs  
If Caltrans is paying for the innovation, the innovator will provide costs for pilot studies identified under item 7.

Separately, the innovator will estimate future unit costs for minimum and maximum project sizes. Note these unit costs are should be representative of production level costs and will be used in establishing life-cycle costs in the final report. Note that these estimates can be adjusted during the evaluation period.

10. Potential problems, impacts and remedies

Identify any potential performance problems and their remedies.

11. Warranties

Would you be willing to provide a warranty? Describe the terms of the warranty.

12. Safety

Attach any MSDS or safety forms received from the NPC, if applicable. Identify any additional safety issues that need to be addressed.

13. Evaluation Plan

Describe how you are going to evaluate the performance. Discuss the type of tests and/or evaluations that will be done, prior to innovation work, during the life of the project and the schedule. Criteria will be established to define success of the innovation. Identify who will be doing the testing and who will be responsible for the final report. A schedule of testing will be provided. This element should follow the recommendations in the Pavement Preservation Studies Technical Advisory Guide.

14. Definition of Success

Describe the performance and cost criteria that will define success. This should be compared to the current Caltrans practice.

15. Submitters

Names and contact information of both the innovator and the Caltrans champion.

#### **A.2.4 Final Report Format**

The following elements should be included in the final report in addition to items 1–15, which are included as the first part of the report.

16. Evaluation Results

Test results prior, during and after construction will be presented.

17. Performance Analysis

Results will be analyzed and the performance will be compared to current Caltrans practices.

18. Life-Cycle Costs

The performance and project costs will be examined for life-cycle costs. It is recommended that the life-cycle costs be compared to current Caltrans practice using the appropriate design lives and discount factors. Future anticipated production costs should be discussed here, also.

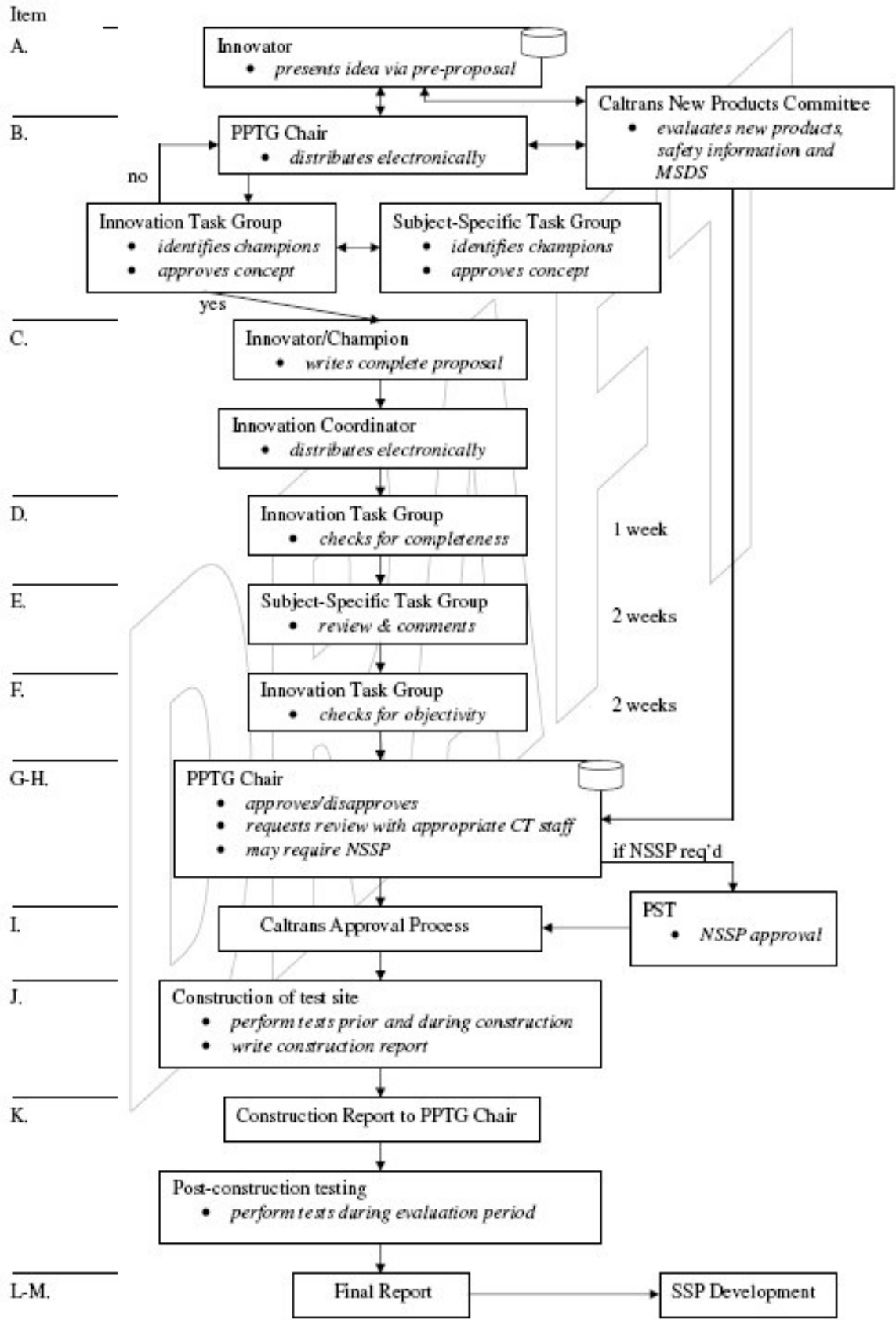
19. Conclusions

Discuss how the innovation compares to current Caltrans practice.

20. Recommendations

Successful innovations should be directed to the appropriate specification committee. Recommendations for improving innovations that “failed” (via the definition set up in step 13) should be described here.

# Innovation Process Flow Chart





---

**APPENDIX B**

**CHECKLISTS**

---



## **APPENDIX B: CHECKLISTS**

---

Examples of the following checklists typically used in pavement preservation experiments are provided in this Appendix:

- Checklist 1: Justification for Study
- Checklist 2: Proposal for a Pavement Preservation Experiment
- Checklist 3: Project Planning
- Checklist 4: Experiment Work Plan Content
- Checklist 5: Experiment Work Plan Document
- Checklist 6: Experiment Initiation
- Checklist 7: Desktop Study
- Checklist 8: Site Selection
- Checklist 9: Site Layout and Marking
- Checklist 10: Preconstruction Assessment
- Checklist 11: Construction Assessment
- Checklist 12: Monitoring Preparation
- Checklist 13: Monitoring
- Checklist 14: Project Closure





CHECKLIST - PROJECT PLANNING MEETING				Checklist 3	
Issue		Yes	No	Comments	
1	Is the objective of the experiment clear?				
2	Have the implications of the findings from the background study been adequately established?				
3	Does the experimental design meet the test objective?				
4	Has a suitable control experiment for comparative purposes been agreed upon?				
5	Has the location of the experiment been decided?				
6	Have all the construction requirements been identified?				
7	Has the instrumentation and equipment required to provide data for envisaged outcome been identified?				
8	Has a monitoring program been drawn up?				
9	Has a monitoring procedure been agreed to?				
10	Have failure and experiment completion criteria been set?				
11	Has an associated laboratory test program been formulated?				
12	Have data collection, validation and storage protocols been agreed upon?				
13	Have report formats and frequency been defined?				
14	Have criteria been set for the treatment/technology/procedure/product to be adopted as standard practice?				
15	Has a plan for implementing the treatment if successful been formulated?				
16	Has consideration been given to repairing the road after testing?				
17	Has responsibility for each of the above been delegated and accepted?				
<b>Recommendation</b>					
Has sufficient information been gathered to prepare an experiment work plan?				Yes	No
If no, state why and what needs to be done to continue					
Name		Signature		Date	

CHECKLIST - EXPERIMENT WORK PLAN CONTENT				Checklist 4	
Content		Yes	No	Comments	
1	Objective of the test				
2	Staffing and contact details				
3	Responsibility and reporting matrix <ul style="list-style-type: none"> <li>• Report preparation</li> <li>• Report approval</li> <li>• Health and safety</li> <li>• Environment</li> <li>• Data collection</li> <li>• Data validation</li> <li>• Data submission</li> </ul>				
4	Experimental design, including details on replicates and controls				
5	Section detail <ul style="list-style-type: none"> <li>• Section number</li> <li>• Section details including district, county, route number, lane number and GPS coordinates</li> <li>• Test panel position</li> <li>• Pavement description</li> <li>• Construction, rehabilitation or maintenance interventions required before testing can begin</li> <li>• Checklists</li> </ul>				
6	Instrumentation <ul style="list-style-type: none"> <li>• Inventory of instruments</li> <li>• Location and/or depth</li> <li>• Calibration</li> <li>• Measurement specifications</li> <li>• Data collection requirements including number and location of points and conditions under which measurements will be recorded</li> <li>• Checklists</li> </ul>				
7	Evaluation program <ul style="list-style-type: none"> <li>• Evaluation detail</li> <li>• Protocols/methods/criteria to be followed</li> <li>• Failure criteria definition</li> <li>• Associated laboratory testing</li> <li>• Checklists</li> </ul>				
8	Data collection, validation and storage <ul style="list-style-type: none"> <li>• Start date</li> <li>• Frequency of data collection</li> <li>• Data validation (visual, comparison with previous measurement, within predefined parameters)</li> <li>• Data transfer to Database Manager (timing, medium)</li> <li>• Criteria to be met for experiment completion</li> <li>• Checklists</li> </ul>				
9	Reports				
10	General notes				
<b>Recommendation</b>					
Has sufficient information been included in the experiment work plan?				Yes	No
If no, state why and what needs to be done to continue					
Name		Signature		Date	









CHECKLIST - SITE SELECTION				Checklist 8	
General issues		Yes	No	Comments	
1	Is the proposed section representative of the issue being investigated?				
2	Is the proposed section conveniently located for monitoring and demonstration purposes?				
3	Will any results obtained from this proposed section be representative of other roads with similar conditions?				
4	Are individual sections within the proposed experiment similar in terms of alignment, structure and condition?				
5	Will the establishment of the proposed section pose a safety hazard to road users?				
6	Will the establishment of the proposed section pose a safety hazard to persons undertaking monitoring evaluations?				
7	Will the road on which the proposed section is planned be maintained or rehabilitated within the monitoring period?				
8	Can planned maintenance be included as part of the evaluation?				
9	If planned maintenance is not part of the evaluation, can steps be taken to ensure that the experiment is not maintained?				
10	Is the proposed section located as close as possible to a traffic counting/weigh-in-motion station?				
11	Can the proposed section be tested to 'failure' and then repaired without significant impacts to the road user?				
12					
<b>Recommendation</b>					
Does the proposed site meet the requirements of the experiment work plan?				Yes	No
If no, state why and what needs to be done to continue					
Name		Signature		Date	





CHECKLIST - CONSTRUCTION ASSESSMENT				Checklist 11	
General issues		Yes	No	Comments	
1	Was the entire process systematically documented?				
2	Were all deviations from the planned process justified and/or explained?				
3	Have the potential influence of the deviations on the experiment performance been quantified?				
4	Were the binder, aggregate and/or premix characteristics documented?				
5	Was the equipment inspected and condition documented?				
6	Was the equipment correctly calibrated?				
7	Was the area of distress adequately prepared?				
8	Was the surfacing/patch/crack seal adequately compacted?				
9	Were establishment, application and demobilization times recorded?				
10	Were appropriate quality control procedures followed?				
11	Was the treatment uniform throughout the experiment?				
12	Was wastage documented?				
13	Were any unanticipated problems encountered and how were they dealt with?				
14	What procedures can be implemented to improve the process?				
15	Were the required measurements taken at the specified intervals?				
16	Were the required samples taken at the specified intervals?				
17	Were instruments installed as specified?				
18	Were the product suppliers satisfied with the experiment?				
<b>Recommendation</b>					
Was the experiment satisfactorily constructed?				Yes	No
If no, state why and what needs to be done to continue					
Name		Signature		Date	



CHECKLIST - MONITORING				Checklist 13	
General issues		Yes	No	Comments	
1	Was the experiment monitored according to the requirements of the experiment work plan?				
2	Was the standard prescribed form used? If not, has all relevant information been captured?				
3	Were all cells on the form completed?				
4	Was the assessment compared to the previous assessment?				
5	Were any significant changes since the previous monitoring accounted for?				
6	Were the required photographs taken?				
7	Were the required physical measurements taken?				
8	Were the required samples taken?				
9	Were the samples logged?				
10	Were the samples delivered and instructions for testing submitted?				
11	Have the data and photographs been captured in a spreadsheet or database?				
12	Have all forms been added to the project file?				
13					
14					
15					
<b>Recommendation</b>					
Was the monitoring exercise successfully completed?				Yes	No
If no, state why and what needs to be done to continue					
Name		Signature		Date	



---

## **APPENDIX C**

### **EXAMPLE EXPERIMENT WORK PLAN**

---



## APPENDIX C: EXAMPLE EXPERIMENT WORK PLAN

---

### C.1 Title

Assessment of international chip seal design methods for pavement preservation purposes

### C.2 Staffing and Contact Details

Submitted by:	[insert name]
Project Engineer/Project Manager:	[insert name]
Project Champion:	[insert name]
Database manager:	[insert name]
Evaluation team:	[insert name]

### C.3 Objective of the Test

To determine whether international chip seal design methods, specifically with regard to aggregate grading and characteristics, are appropriate for California and will result in improved seal performance.

Treatments will be applied to roads in fair condition as a preservation strategy (i.e., prolonging the life of the pavement) and not for rehabilitation.

### C.4 Responsibility and Reporting Matrix

- Report preparation - Project Engineer
- Report approval - Project Champion, Chief of the Office of Pavement Preservation
- Health and safety - Project Engineer
- Environment - Project Engineer
- Data collection - Project Engineer
- Data validation - Database Manager
- Data submission - Project Engineer

Reporting matrix - All project-related communication through the Project Engineer

### C.5 Experimental Design

- Control design - Standard Caltrans design (See Appendix 1 for design)

- Seal 1 - Tightly controlled grading with binder x (See Appendix 1 for design)
- Seal 2 - Tightly controlled grading with binder y (See Appendix 1 for design)
- Section length - 1.0 km per treatment (i.e., 3.0 km per experiment)
- Visual assessment section - middle 200 m of each section
- Skid resistance - middle 600 m of each section

## C.6 Section Detail

Climate	Traffic	Road Detail				
		County	Route number	Post mile	Lane number	Direction
Coastal	Low	Humboldt	SR?		1	N
		-	-		-	-
	High	Ventura	SR?		1	N
		-	-		-	-
Valley	Low	Fresno	SR?		1	S
		Riverside	SR?		1	E
	High	Yuba	SR?		1	E
		Yuba	SR?		1	N
Mountain	Low	Lassen	SR?		1	W
		Modoc	SR?		1	N
	High	Inyo	SR?		1	E
		-	-		-	-

Climate	Traffic	Experiment Number		
		Control	Seal 1	Seal 2
Coastal	Low	PPTS/1/05/1/1	PPTS/1/05/1/2	PPTS/1/05/1/3
		-	-	-
	High	PPTS/7/05/2/1	PPTS/1/05/2/2	PPTS/1/05/2/3
		-	-	-
Valley	Low	PPTS/6/05/3/1	PPTS/6/05/3/2	PPTS/6/05/3/3
		PPTS/8/05/4/1	PPTS/8/05/3/2	PPTS/8/05/3/3
	High	PPTS/3/05/5/1	PPTS/3/05/5/2	PPTS/7/05/5/3
		PPTS/3/05/5/4	PPTS/3/05/5/5	PPTS/7/05/5/6
Mountain	Low	PPTS/2/05/6/1	PPTS/2/05/6/2	PPTS/2/05/6/3
		PPTS/2/05/7/1	PPTS/3/05/7/2	PPTS/3/05/7/3
	High	PPTS/9/05/8/1	PPTS/9/05/8/2	PPTS/9/05/8/3
		-	-	-

Climate	Traffic	GPS Coordinates		
		Control	Seal 1	Seal 2
Coastal	Low			
	High			
Valley	Low			
	High			
Mountain	Low			
	High			

Climate	Traffic	Pavement condition		
		Control	Seal 1	Seal 2
Coastal	Low	AC, Alligator B cracking, no preparation required -		
	High	AC, Bleeding, <20%, no pre-preparation required -		
Valley	Low	AC, Patching, continuous in outer wheel track, no pre-preparation required AC, No distress		
	High	AC, Alligator A, no pre-preparation required AC, Ravelling, <10%, no pre-preparation required		
Mountain	Low	AC, Alligator A, no pre-preparation required AC, No distress		
	High	AC, Bleeding, <20%, no pre-preparation required -		

## C.7 Section Map

See Appendix 2

## C.8 Pre-construction and Construction Checklists

See Appendix 3

## C.9 Construction Procedure

See Appendix 1

## C.10 Instrumentation

Temperature buttons to be installed at 50 mm depth between the wheel paths in Panels A and C. The buttons must be installed and calibrated according to the manufacturer's instructions. Holes should be sealed with cold mix patch filler. Button settings should be programmed to read every 60 minutes.

Weather information to be collected from Caltrans District Maintenance offices.

No other instrumentation is planned

### **C.11 Evaluation Plan**

- Timing
  - Construction
  - Construction + two weeks
  - Construction + 6 months
  - Construction + 12 months
  - Annual
- Evaluation detail
  - Visual assessment - Caltrans Pavement Condition Survey Manual, FHWA LTPP Distress Identification Manual
  - Skid resistance - International Friction Index
  - Forms - See Appendix 3
  - Spreadsheet - See attached spreadsheet
- Failure criteria definition
  - Surface cracking - 2.5 m/m<sup>2</sup> total crack density
  - Bleeding - >wheel path aggregate completely covered
  - Ravelling - >20% of total area
  - Surface debonding - >5% of total area
  - International Friction Index - >2.7 m/km

### **C.12 Associated Laboratory Testing**

- Control tests (Methods detailed in Appendix 1)
  - Aggregate
    - Grading
    - Crushing strength
    - Flakiness index
    - Polishing value
  - Binder
    - Grade
    - Softening point
    - Dynamic viscosity
    - Ductility

- Elastic recovery
- Stability
- Adhesion

### **C.13 Data Validation and Storage**

- Data validation - visual, comparison with previous measurement forms
- Data transfer to Database Manager - within 10 days of evaluation
- Criteria to be met for experiment completion - failure criteria not reached after 5 years
- Checklists - See Appendix 3

### **C.14 Reports**

- Construction report (30 days after construction of final section)
- Annual evaluation report (30 days after evaluation of final section)
- Final report, including implementation plan (30 days after final evaluation)

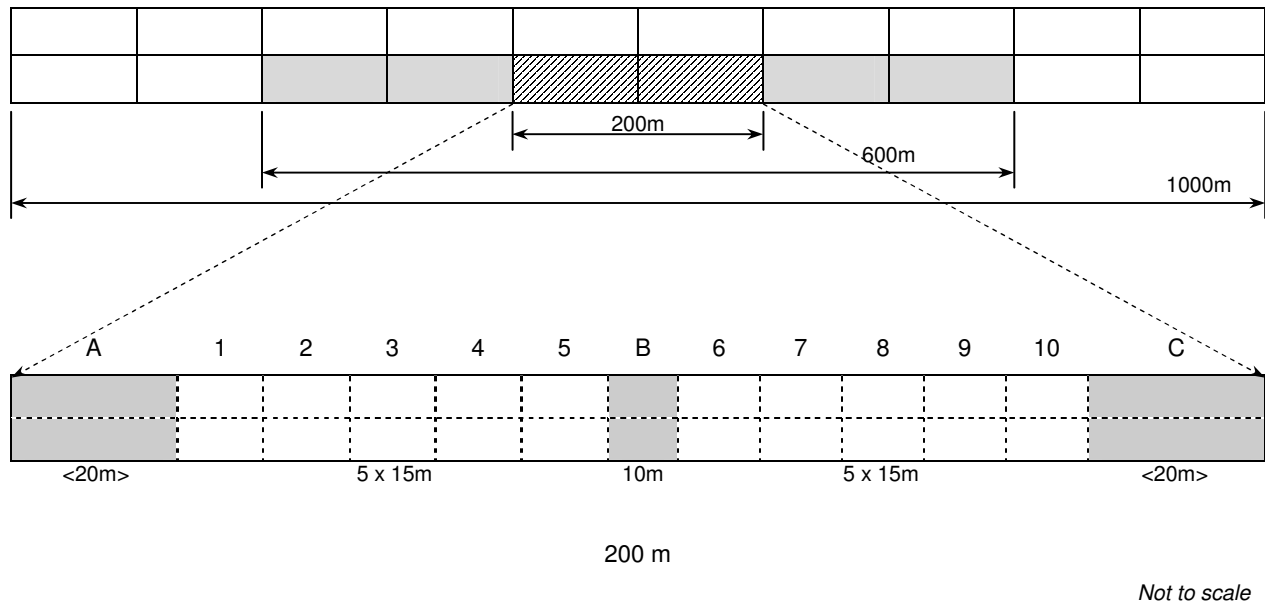
### **C.15 General Notes**

General notes

### **Appendix C.1: Seal Design and Construction Procedure**

Reference to specific seal design and construction procedure to be followed.

## Appendix C.2: Section Layout



## Appendix C.3: Checklists and Forms

- List of checklists and forms with examples on following pages

VISUAL ASSESSMENT FORM - FLEXIBLE PAVEMENTS														Form 2			
Section No	Location					Date			Evaluator					Panel			
Surfacing assessment														Panel			
Surfacing type																	
Texture	Varying			Fine			F - M			Medium			M - C			Course	
Voids	Varying			None			N - F			Few			F - M			Many	
	Degree						Extent					Length	Width	Number	Panel		
	Slight			Severe			<5		>80								
Mechanical failure	0	1	2	3	4	5	1	2	3	4	5						
Other failure	0	1	2	3	4	5	1	2	3	4	5						
Bleeding/flushing	0	1	2	3	4	5	1	2	3	4	5	Narrow	Wide	Position			
Surface cracks	0	1	2	3	4	5	1	2	3	4	5						
Binder condition	0	1	2	3	4	5	1	2	3	4	5	Active	Stable	Position			
Aggregate loss	0	1	2	3	4	5	1	2	3	4	5						
Structural assessment																	
	Degree						Extent					Narrow (% area)	Wide (% area)	Position	Panel		
	Slight			Severe			<5		>80								
Cracks - block	0	1	2	3	4	5	1	2	3	4	5						
Cracks - longitudinal	0	1	2	3	4	5	1	2	3	4	5						
Cracks transverse	0	1	2	3	4	5	1	2	3	4	5						
Cracks - crocodile	0	1	2	3	4	5	1	2	3	4	5						
Cracks - parabolic	0	1	2	3	4	5	1	2	3	4	5						
Pumping	0	1	2	3	4	5	1	2	3	4	5	Number	Diameter				
Rutting	0	1	2	3	4	5	1	2	3	4	5						
Undulation/settling	0	1	2	3	4	5	1	2	3	4	5						
Edgebreak	0	1	2	3	4	5	1	2	3	4	5						
Potholes	0	1	2	3	4	5	1	2	3	4	5						
Delamination	0	1	2	3	4	5	1	2	3	4	5						
Patching/digouts	0	1	2	3	4	5	1	2	3	4	5	Small	Medium	Large	Panel		
Functional assessment																	
	Degree					Influencing factors											
	Good		Poor			Pothole	Patch	Undulation	Corrugation	Rut							
Riding quality	1	2	3	4	5												
Skid resistance	1	2	3	4	5	Bleed	Polish										
Surface drainage	1	2	3	4	5												
Side drainage	✓	×															
Notes											Photos						
Compared with previous evaluation?											Y	N					

---

**APPENDIX D**

**DATA COLLECTION FORMS**

---



## **APPENDIX D: DATA COLLECTION FORMS**

---

Examples of the following forms typically used for the monitoring of pavement preservation experiments are provided in this Appendix:

- Form 1: Visual Assessment Form Used for Chip Seal Evaluation (alternative to Pavement Condition Survey standard form)
- Form 2: Profile Assessment
- Form 3: Construction Assessment Form for Chip Seal Application
- Form 4: Materials Inventory
- Form 5: Project Site Report
- Form 6: Section Sketch
- Form 7: Core Log
- Form 8: Test Pit Sketch
- Form 9: Log for Surfacing Layers
- Form 10: Log for Granular and Stabilized Base
- Form 11: Photographs
- Form 12: Density and Moisture Content
- Form 13: DCP







**PAVEMENT PRESERVATION EXPERIMENT PROFILE ASSESSMENT FORM**

**Form 3(a)**

Transverse																								Section No			
Panel A				Panel 1				Panel 2				Panel 3				Panel 4				Panel 5				Panel			
Max rut	Width			Max rut	Width			Max Rut	Width			Max Rut	Width			Max Rut	Width			Max Rut	Width			Date			
Lane Center				Lane Center				Lane Center				Lane Center				Lane Center				Lane Center				1 - 5			
2.1			1.9	2.1			1.9	2.1			1.9	2.1			1.9	2.1			1.9	2.1			1.9	2.1			1.9
2.2			1.8	2.2			1.8	2.2			1.8	2.2			1.8	2.2			1.8	2.2			1.8	2.2			1.8
2.3			1.7	2.3			1.7	2.3			1.7	2.3			1.7	2.3			1.7	2.3			1.7	2.3			1.7
2.4			1.6	2.4			1.6	2.4			1.6	2.4			1.6	2.4			1.6	2.4			1.6	2.4			1.6
2.5			1.5	2.5			1.5	2.5			1.5	2.5			1.5	2.5			1.5	2.5			1.5	2.5			1.5
2.6			1.4	2.6			1.4	2.6			1.4	2.6			1.4	2.6			1.4	2.6			1.4	2.6			1.4
2.7			1.3	2.7			1.3	2.7			1.3	2.7			1.3	2.7			1.3	2.7			1.3	2.7			1.3
2.8			1.2	2.8			1.2	2.8			1.2	2.8			1.2	2.8			1.2	2.8			1.2	2.8			1.2
2.9			1.1	2.9			1.1	2.9			1.1	2.9			1.1	2.9			1.1	2.9			1.1	2.9			1.1
3.0			1.0	3.0			1.0	3.0			1.0	3.0			1.0	3.0			1.0	3.0			1.0	3.0			1.0
3.1			0.9	3.1			0.9	3.1			0.9	3.1			0.9	3.1			0.9	3.1			0.9	3.1			0.9
3.2			0.8	3.2			0.8	3.2			0.8	3.2			0.8	3.2			0.8	3.2			0.8	3.2			0.8
3.3			0.7	3.3			0.7	3.3			0.7	3.3			0.7	3.3			0.7	3.3			0.7	3.3			0.7
3.4			0.6	3.4			0.6	3.4			0.6	3.4			0.6	3.4			0.6	3.4			0.6	3.4			0.6
3.5			0.5	3.5			0.5	3.5			0.5	3.5			0.5	3.5			0.5	3.5			0.5	3.5			0.5
3.6			0.4	3.6			0.4	3.6			0.4	3.6			0.4	3.6			0.4	3.6			0.4	3.6			0.4
3.7			0.3	3.7			0.3	3.7			0.3	3.7			0.3	3.7			0.3	3.7			0.3	3.7			0.3
3.8			0.2	3.8			0.2	3.8			0.2	3.8			0.2	3.8			0.2	3.8			0.2	3.8			0.2
3.9			0.1	3.9			0.1	3.9			0.1	3.9			0.1	3.9			0.1	3.9			0.1	3.9			0.1
CL			RE	CL			RE	CL			RE	CL			RE	CL			RE	CL			RE	CL			RE

Evaluator

Long			Transverse																				Section No
Lane center	Inner	Outer	Position	Panel 10	Width	Max Rut	Panel 9	Width	Max Rut	Panel 8	Width	Max Rut	Panel 7	Width	Max Rut	Panel 6	Width	Max Rut	Panel 5	Width	Max Rut	Panel B	
				Lane Center	Lane Center	Lane Center	Lane Center	Lane Center	Lane Center	Lane Center	Lane Center	Lane Center	Lane Center	Lane Center	Max Rut								
			1	2.1		1.9	2.1		1.9	2.1		1.9	2.1		1.9	2.1		1.9	2.1		1.9	2.1	1.9
				2.2		1.8	2.2		1.8	2.2		1.8	2.2		1.8	2.2		1.8	2.2		1.8	2.2	1.8
			2	2.3		1.7	2.3		1.7	2.3		1.7	2.3		1.7	2.3		1.7	2.3		1.7	2.3	1.7
				2.4		1.6	2.4		1.6	2.4		1.6	2.4		1.6	2.4		1.6	2.4		1.6	2.4	1.6
			3	2.5		1.5	2.5		1.5	2.5		1.5	2.5		1.5	2.5		1.5	2.5		1.5	2.5	1.5
				2.6		1.4	2.6		1.4	2.6		1.4	2.6		1.4	2.6		1.4	2.6		1.4	2.6	1.4
			4	2.7		1.3	2.7		1.3	2.7		1.3	2.7		1.3	2.7		1.3	2.7		1.3	2.7	1.3
				2.8		1.2	2.8		1.2	2.8		1.2	2.8		1.2	2.8		1.2	2.8		1.2	2.8	1.2
			5	2.9		1.1	2.9		1.1	2.9		1.1	2.9		1.1	2.9		1.1	2.9		1.1	2.9	1.1
				3.0		1.0	3.0		1.0	3.0		1.0	3.0		1.0	3.0		1.0	3.0		1.0	3.0	1.0
			6	3.1		0.9	3.1		0.9	3.1		0.9	3.1		0.9	3.1		0.9	3.1		0.9	3.1	0.9
				3.2		0.8	3.2		0.8	3.2		0.8	3.2		0.8	3.2		0.8	3.2		0.8	3.2	0.8
			7	3.3		0.7	3.3		0.7	3.3		0.7	3.3		0.7	3.3		0.7	3.3		0.7	3.3	0.7
				3.4		0.6	3.4		0.6	3.4		0.6	3.4		0.6	3.4		0.6	3.4		0.6	3.4	0.6
			8	3.5		0.5	3.5		0.5	3.5		0.5	3.5		0.5	3.5		0.5	3.5		0.5	3.5	0.5
				3.6		0.4	3.6		0.4	3.6		0.4	3.6		0.4	3.6		0.4	3.6		0.4	3.6	0.4
			9	3.7		0.3	3.7		0.3	3.7		0.3	3.7		0.3	3.7		0.3	3.7		0.3	3.7	0.3
				3.8		0.2	3.8		0.2	3.8		0.2	3.8		0.2	3.8		0.2	3.8		0.2	3.8	0.2
			10	3.9		0.1	3.9		0.1	3.9		0.1	3.9		0.1	3.9		0.1	3.9		0.1	3.9	0.1
				CL		RE	CL		RE	CL		RE	CL		RE	CL		RE	CL		RE	CL	RE

Panel

6 - 10

Form 3(b)



PAVEMENT PRESERVATION EXPERIMENT INVESTIGATION - PROJECT SITE REPORT				Form 5	
Section No		Date			
Start time		Completion time			
Responsibility		Crew chief			
Head driller		Crew size			
Traffic control		Repair			
Weather					
Equipment					
Description of work and comments					
Samples	Description	Shipped to	Shipped by	Date	
Site problems	Equipment	Traffic	Other		
Forms					
Sketch		Materials inventory		Core log	Pit assessment
DCP		Density/moisture		List of photographs	
Pit reinstated			Site cleaned		
Responsible person sign			Date		







**PAVEMENT PRESERVATION EXPERIMENT INVESTIGATION - TEST PIT SKETCH**

**Form 8**

**Section No:**

**Profiled by:**

**Date:**

**Zone 5**  
(IWT to centerline)

**Zone 4**  
(IWT)

**Zone 3**  
(Between tracks)

**Zone 2**  
(OWT)

**Zone 1**  
(Shoulder to OWT)



**PAVEMENT PRESERVATION EXPERIMENT INVESTIGATION - WEARING COURSE LAYERS**

**Form 9**

<b>Section No:</b>		<b>Profiled by:</b>			<b>Date:</b>			
<b>Depth (mm)</b>	<b>Descriptor</b>	<b>Zone 1 (Shoulder to OWT)</b>	<b>Zone 2 (OWT)</b>	<b>Zone 3 (Between tracks)</b>	<b>Zone 4 (IWT)</b>	<b>Zone 5 (IWT to centerline)</b>	<b>Sample No</b>	
to								
to								
to								
to								
to								
to								
<b>Interlayer bond</b>								
<b>Checklist</b>	<b>Cracks</b>	<b>Description</b>						
	<b>Rutting</b>	<b>Heaving</b>	<b>Bleeding</b>	<b>Raveling</b>				
	<b>Interface bond</b>	<b>Moisture at interface</b>	<b>Layer definition</b>	<b>Pumping</b>				
<b>Other</b>								

**PAVEMENT PRESERVATION EXPERIMENT INVESTIGATION - LOG FOR GRAVEL AND STABILIZED LAYERS**

**Form 10**

Section No		Profiled by:				Date:			
Depth (mm)	Descriptor	Moisture	Color	Consistency	Structure	Size	Other	Sample	
to									
to									
to									
to									
to									
to									
to									

**Surface/layer bond**

<b>Checklist</b>	Cracks		Description							
	Rutting		Pumping		Interface bond		Moisture at interface		Layer definition	
	Carbonation									
<b>Other</b>										



PAVEMENT PRESERVATION EXPERIMENT DENSITY & MOISTURE CONTENT							Form 12
Section No		Date		Evaluator			
Calibration	Prv	Std	Std	Std	Calibrated by		
Std MC					Calibration date		
Std wet density							
Panel A	Probe	Input	Actual	Wet	Dry	MC	Notes
	24	200	600				
	22	200	550				
	20	200	500				
	18	200	450				
	16	200	400				
	14	200	350				
	12	200	300				
	10	200	250				
	8	200	200				
	6	150	150				
4	100	100					
2	50	50					
Panel B	24	200	600				
	22	200	550				
	20	200	500				
	18	200	450				
	16	200	400				
	14	200	350				
	12	200	300				
	10	200	250				
	8	200	200				
	6	150	150				
	4	100	100				
2	50	50					
Panel C	24	200	600				
	22	200	550				
	20	200	500				
	18	200	450				
	16	200	400				
	14	200	350				
	12	200	300				
	10	200	250				
	8	200	200				
	6	150	150				
	4	100	100				
2	50	50					
<b>Gravimetric moisture content</b>							
	Sample depth	Tin No	Moisture content	Actual dry density	Notes		
Test A							
Test B							
Test C							
Validated by					Signature		

PAVEMENT PRESERVATION EXPERIMENT DCP RECORDING SHEET								Form 13
Section No		Panel		Date		Operator		
Position A		Position B		Position C				
0			0			0		
5	205	405	5	205	405	5	405	
10	210	410	10	210	410	10	410	
15	215	415	15	215	415	15	415	
20	220	420	20	220	420	20	420	
25	225	425	25	225	425	25	425	
30	230	430	30	230	430	30	430	
35	235	435	35	235	435	35	435	
40	240	440	40	240	440	40	440	
45	245	445	45	245	445	45	445	
50	250	450	50	250	450	50	450	
55	255	455	55	255	455	55	455	
60	260	460	60	260	460	60	460	
65	265	465	65	265	465	65	465	
70	270	470	70	270	470	70	470	
75	275	475	75	275	475	75	475	
80	280	480	80	280	480	80	480	
85	285	485	85	285	485	85	485	
90	290	490	90	290	490	90	490	
95	295	495	95	295	495	95	495	
100	300	500	100	300	500	100	500	
105	305	505	105	305	505	105	505	
110	310	510	110	310	510	110	510	
115	315	515	115	315	515	115	515	
120	320	520	120	320	520	120	520	
125	325	525	125	325	525	125	525	
130	330	530	130	330	530	130	530	
135	335	535	135	335	535	135	535	
140	340	540	140	340	540	140	540	
145	345	545	145	345	545	145	545	
150	350	550	150	350	550	150	550	
155	355	555	155	355	555	155	555	
160	360	560	160	360	560	160	560	
165	365	565	165	365	565	165	565	
170	370	570	170	370	570	170	570	
175	375	575	175	375	575	175	575	
180	380	580	180	380	580	180	580	
185	385	585	185	385	585	185	585	
190	390	590	190	390	590	190	590	
195	395	595	195	395	595	195	595	
200	400	600	200	400	600	200	600	
<b>Validated by</b>				<b>Signature</b>				





---

**APPENDIX E**

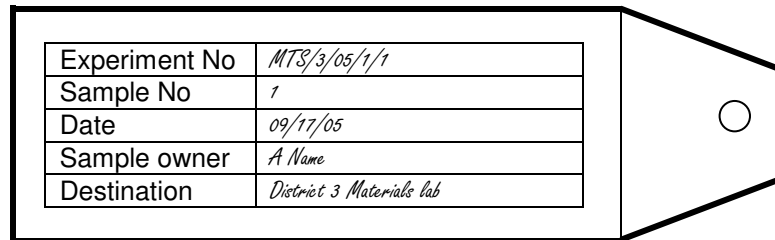
**EXAMPLE SAMPLE LABEL**

---

## APPENDIX E: EXAMPLE SAMPLE LABEL

---

Experiment No	<i>MTS/3/05/1/1</i>
Sample No	<i>1</i>
Date	<i>09/17/05</i>
Sample owner	<i>A Name</i>
Destination	<i>District 3 Materials lab</i>



Sample description
<i>Core - DWP cracked</i>
.....
.....

